

TripleGauge™

Bayard-Alpert Pirani Capacitance Diaphragm Gauge
With Fieldbus Interface

BCG450-PN, BCG450-SD, BCG450-SE,
BCG450-SP

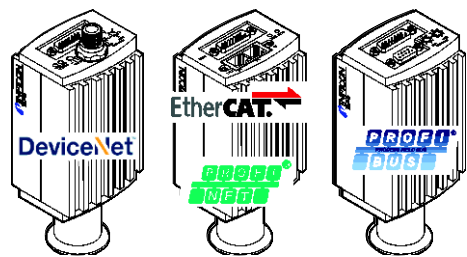

Instruction Sheet

tima41e1-d (2020-06)

About this document

This document is a supplement to the standard Instruction Sheet enclosed with the BCG450 ([1]). It should be used together with the standard Instruction Sheet.

The symbol (→ [XY]) refers to documents and files listed under "Further Information".

Validity

This document applies to products with the following part numbers:

BCG450-PN (Profibus):
353-517 (DN 25 ISO-KF)
353-518 (DN 40 CF-R)

BCG450-SD (DeviceNet):
353-557 (DN 25 ISO-KF)
353-558 (DN 40 CF-R)
353-562 (DN 25 ISO-KF, with baffle)

BCG450-SE (EtherCAT):
Latest EtherCAT version (ETG.5003.2080 S (R) V1.3.0)
353-598 (DN 25 ISO-KF)
353-599 (DN 40 CF-R)
Old EtherCAT version (ETG.5003.2080 S (R) V1.0.0)
353-592 (DN 25 ISO-KF)
353-593 (DN 40 CF-R)

BCG450-SP (Profibus):
353-554 (DN 25 ISO-KF)
353-556 (DN 40 CF-R)

The part number (PN) can be taken from the product name-plate.

If not indicated otherwise in the legends, the illustrations in this document correspond to the vacuum connection DN 25 ISO-KF. They apply to other vacuum connections by analogy.

Intended Use

The BCG450-PN, BCG450-SD, BCG450-SE and BCG450-SP gauges have been designed for vacuum measurement of gases in the pressure range 5×10⁻¹⁰ ... 1500 mbar.

They must not be used for measuring flammable or combustible gases in mixtures containing oxidants (e.g. atmospheric oxygen) within the explosion range.

Safety

Symbols Used



Information on preventing any kind of physical injury.



Caution

Information on correct handling or use. Disregard can lead to malfunctions or minor equipment damage.

Personnel Qualifications



Skilled personnel

All work described in this document may only be carried out by persons who have suitable technical training and the necessary experience or who have been instructed by the end-user of the product.

General Safety Instructions

All safety instructions given in [1] and [2] apply to the sensor types described in this document, too.

Liability and Warranty

INFICON assumes no liability and the warranty becomes null and void if the end-user or third parties

- disregard the information in this document
- use the product in a non-conforming manner
- make any kind of changes (modifications, alterations etc.) to the product
- use the product with accessories not listed in the product documentation.

The end-user assumes the responsibility in conjunction with the process media used.

Gauge failures due to contamination or wear and tear, as well as expendable parts (e.g. filament), are not covered by the warranty.

BCG450-SD

General Information

The BCG450-SD gauge has a fieldbus interface that conforms to the DeviceNet standard (→ [11]).

Via this interface, the following and further data are exchanged in the standardized DeviceNet Protocol (→ [3], [11]):

- Pressure reading
- Pressure unit (mbar, Torr, Pa)
- Degas function
- Status and error messages

Two adjustable switching functions are integrated in the gauge. With the built-in atmosphere switching function an atmospheric pressure threshold can be programmed (→ [2]). The corresponding relay contacts are available at the sensor cable connector.

The basic sensor and sensor electronics of the BCG450-SD type are the same as in the standard BCG450 (→ [1], [2]).

Technical Data

General technical data of the sensor and sensor electronics → [1], [2]

Fieldbus Interface

Fieldbus name	DeviceNet
Standard applied	→ [11]
Communication protocol, data format	→ [3], [11]
Interface, physical	CAN bus

DeviceNet Parameters	
Data rate (adjustable via "RATE" switch)	125 kBaud 250 kBaud 500 kBaud (default) "P" (programmable) 125 kBaud, 250 kBaud, 500 kBaud via DeviceNet (→ [3])
Node address (MAC ID) (adjustable via "ADDRESS, MSD, LSD" switches)	0 ... 63 _{dec} (default 63 _{dec}) "P" (programmable) 0 ... 63 _{dec} via DeviceNet (→ [3])

DeviceNet connector	Micro-Style, 5-pin, male
Cable	Shielded special DeviceNet cable, 5 conductors (→ [9], [11])
Cable length, system wiring	According to DeviceNet specifications (→ [9], [11])

Supply Voltages

Supply voltage at the sensor connector, Pin 8	+24 V (dc) (+20 ... +28 V)
Power consumption	<20 W

DeviceNet operation requires an additional, separate power supply.



DANGER

The gauge may only be connected to power supplies, instruments or control devices that conform to the requirements of a grounded protective extra-low voltage. The connection to the gauge has to be fused.

Supply voltage at the DeviceNet connector, Pin 2	+24 V (dc) (+11 ... +25 V)
Power consumption	<2 W

The gauge is protected from reversed polarity of the supply voltage.

Sensor Cable Connection

For reasons of compatibility, the expression "sensor cable" is used in this document, although the pressure reading of the SD-type gauge is normally transmitted via the DeviceNet interface.

Connector	D-sub, 15-pin, male
Cable	max. 15 conductors, shielded
Cable length, (conductor cross section per conductor)	≤35 m (0.25 mm ²) ≤50 m (0.34 mm ²) ≤100 m (1.0 mm ²)

Switching functions	2 Setpoints adjustable via potentiometers (Setpoints A and B), one floating, normally open contact per setpoint
Relay contact rating	≤60 V (dc), ≤0.5 A (dc)

Atmosphere switching function → [2]

Gauge identification 42 kΩ between Pin 10 and Pin 5 (sensor cable)

Grounding principle → "Power Connection"

Dimensions [mm]

Housing and vacuum connection → [1], [2]

Gauges with DeviceNet interface are 14 mm longer.

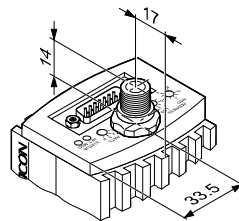

Weight	353-557 / -562 ≈445 g 353-558 ≈710 g
--------	---

Power Connection

Sensor Cable Connection

Make sure the vacuum connection is properly made (→ [1], [2], "Vacuum Connection").

- If no sensor cable is available, make one according to the diagram.

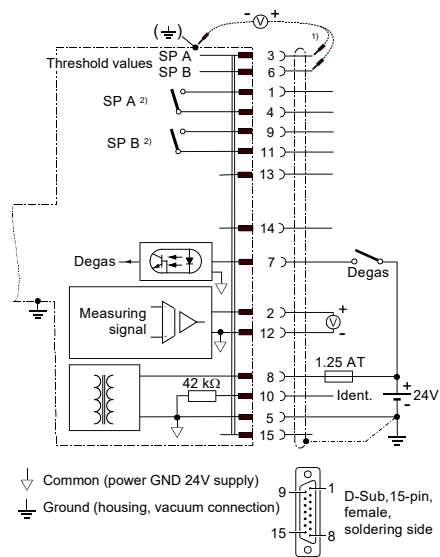

Electrical Connection

Pin 1	Relay switching function A, NO contact	2)
Pin 2	Measuring signal output	0 ... +10.13 V
Pin 3	Threshold (setpoint) A	1) 0 ... +10 V
Pin 4	Relay switching function A, com contact	2)
Pin 5	Supply common	0 V
Pin 6	Threshold (setpoint) B	1) 0 ... +10 V
Pin 7	Degas on, active high	0 V/+24 V
Pin 8	Supply	+24 V
Pin 9	Relay switching function B, NO contact	2)
Pin 10	Gauge identification	
Pin 11	Relay switching function B, com contact	2)
Pin 12	Measuring signal common	
Pin 13	Do not connect	
Pin 14	Do not connect	
Pin 15	Do not connect	

- Do not connect pin 3 and pin 6 for normal operation of the gauge. These pins are reserved for adjustment of the setpoint potentiometers (→ "Setting the Switching Functions").
- Reprogrammable for atmosphere switching function via fieldbus interface (→ [2]).

- Connect the sensor cable to the gauge and secure it using the lock screws

DeviceNet Cable Connection

- If no DeviceNet cable is available, make one according to the following indications:

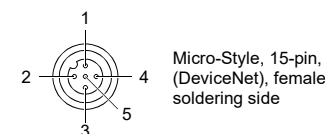

Pin 1	Drain	
Pin 2	Supply (DeviceNet interface only)	+24 V (dc)
Pin 3	Supply common (DeviceNet interface only)	GND
Pin 4	CAN_H	
Pin 5	CAN_L	

- Connect the DeviceNet cable to the gauge and lock the cable connector.

Operation



Caution



Caution: data transmission errors
The attempt to operate the BPG450-SD with the RS232C interface causes data transmission errors.
The BPG450-SD must not be operated with the RS232C interface.

Operating Software

Before the gauge is put into operation, it has to be configured for the DeviceNet. A configuration tool and the device specific EDS file (Electronic Data Sheet) are required for this purpose. This software can be downloaded via internet (→ [8]).

Node Address Setting

Set the node address (0 ... 63_{dec}) via the "ADDRESS" "MSD" and "LSD" switches (default 63_{dec}). The node address is pulled by the firmware when the gauge is switched on. If the setting deviates from the stored value, the new value is taken over into the NVRAM. If a setting higher than 63 is made, the previous node address setting remains valid.

If the MSD switch is in the "P" position, the node address is programmable via the DeviceNet (→ [3]).

Data Rate Setting

By means of the "RATE" switch, the data rate can be set to 125 ("1"), 250 ("2") or 500 kBaud ("5") (default 500 kBaud).

If the switch is in any of the "P" positions, the data rate is programmable via the DeviceNet (→ [3]).

Adjusting the Gauge

Gauge adjustment is carried out automatically, no manual adjustment is required (adjustment of the atmosphere sensor → [2]).

Adjusting the Switching Functions

→ Adjustment and settings.

Status Lights



"STATUS MOD" (gauge status):

Light status	Meaning
Dark	No supply
Flashing red/green	Selftest
Green	Normal operation
Red	Non recoverable error
Flashing red	Recoverable error (e.g. missing DeviceNet power supply).

"STATUS NET" (network status):

Light status	Meaning
Dark	Gauge not online: – Selftest not yet concluded – No supply, → "STATUS MOD" light
Flashing green	Gauge online but no connection: – Selftest concluded, but no connection to other nodes established – Gauge not assigned to any master
Green	Gauge online; necessary connections established
Flashing red	One or several input/output connections in "time out" status
Red	Communication error. The gauge has detected an error that impedes communication via the network (e.g. two identical node addresses (MAC ID) or "Bus-off")

BCG450-SE



General Information

The BCG450-SE gauge has a fieldbus interface that conforms to the EtherCAT Technology Group (ETG) and to the EtherCAT Semiconductor Device Profile (→ [13], [14], [15], [16]). Via this interface, the following and further data are exchanged in the standardized EtherCAT Protocol (→ [1], [2]):

- Pressure reading
- Pressure unit (mbar, Torr, Pa)
- Degas function
- Status and error messages

Two adjustable switching functions are integrated in the gauge. The corresponding relay contacts are available at the sensor cable connector.

The basic sensor and sensor electronics of the BCG450-SE type are the same as in the standard BCG450 (→ [1], [2]).

Technical Data

General technical data of the sensor and sensor electronics → [1], [2].

Fieldbus Interface

Fieldbus name	EtherCAT
Standard applied, data format, communication protocol	353-592, 353-593 → [13], [14] 353-598, 353-599 → [15], [16]
Data rate	100 Mbps
Node address	explicit device identification
Physical layer	100Base-Tx (IEEE 802.3)
EtherCAT connector	2×RJ45, 8-pin (socket) <IN>: EtherCAT input <OUT>: EtherCAT output
Cable	shielded, 8-pin special Ethernet Patch cable (quality CAT5e or higher)
Cable length	≤100 m

Supply Voltages



The power consumption of the BCG450-SE is higher than that of the standard BCG450.

Supply voltage at sensor cable connector, pin 8	+24 V (dc) (+20 ... +28 V)
Power consumption	≤21 W

Sensor Cable Connection

→ "Technical Data, Sensor Cable Connection" of the gauge BCG450-SD (identical).

Dimensions

Housing and vacuum connection → [1], [2]

Weight	353-592, 353-598 ≈445 g 353-593, 353-599 ≈710 g
--------	--

Power Connection

Make sure the vacuum connection is properly made (→ [1], [2], "Vacuum Connection").

Sensor Cable Connection

- If no sensor cable is available, make one according to the diagram shown in the BCG450-SD section (identical).
- Connect the sensor cable to the gauge and secure the sensor cable connector using the lock screws.



tima41e1-e
Original: German tima41d1-3 (2020-06)

EtherCAT Cable Connection

- If no Ethernet cables are available, make two according to the following indications:

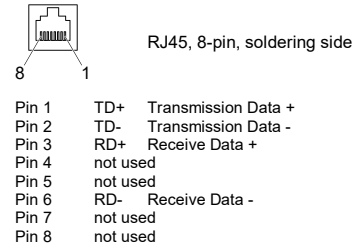

- Connect the Ethernet cables to the gauge: From the previous device the cable connected to the OUT port has to be connected to the BCG450-SE <IN> port. And the cable from the BCG450-SE <OUT> port has to be connected to the next device's <IN> port.

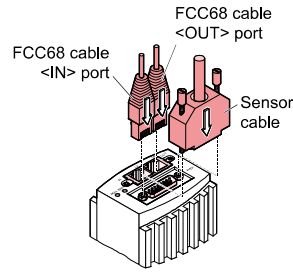

Operation

Caution

Caution: data transmission errors

If the gauge is operated via an RS232 interface and the EtherCAT at the same time, data transmission errors may occur.

The gauge must not be operated via an RS232 interface and the EtherCAT at the same time.

Operating Software

For operating the gauge via EtherCAT, prior installation of the device specific ESI file is required on the bus master side. This file can be downloaded from our website.

Explicit Device Address Setting

During device initialization, the device address switches are read by the device firmware. This device address is supported to the master as Explicit Device Identification.

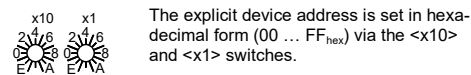

Adjusting the Gauge

→ Adjustment and settings.

Adjusting the Switching Functions

→ "Adjustment and settings".

BCG450-PN

General Information

The BCG450-PN gauge has a fieldbus interface that conforms to the Profinet technology (→ [16]).

Via this interface, the following and further data are exchanged in the standardized Profinet Protocol (→ [7], [16]):

- Pressure reading
- Pressure unit (mbar, Torr, Pa)
- Degas function
- Status and error messages

Two adjustable switching functions are integrated in the gauge. The corresponding relay contacts are available at the sensor cable connector.

The basic sensor and sensor electronics of the BCG450-PN type are the same as in the standard BCG450 (→ [1], [2]).

Technical Data

General technical data of the sensor and sensor electronics → [1], [2].

Fieldbus Interface

Fieldbus name	Profinet
Standard applied, data format, communication protocol	→ [7], [16]
Data rate	100 Mbps
Physical layer	100Base-Tx (IEEE 802.3)

EtherCAT connector	2×RJ45, 8-pin (socket) <IN>: Profinet input <OUT>: Profinet output
Cable	shielded, 8-pin special Ethernet Patch cable (quality CAT5e or higher)
Cable length	≤100 m

Supply Voltages

The power consumption of the BCG450-PN is higher than that of the standard BCG450.

Supply voltage at sensor cable connector, pin 8	+24 V (dc) (+20 ... +28 V)
Power consumption	≤21 W

Sensor Cable Connection

→ "Technical Data, Sensor Cable Connection" of the gauge BCG450-SD (identical).

Dimensions

Housing and vacuum connection → [1], [2]

Weight	
353-517	≈445 g
353-518	≈710 g

Power Connection

Make sure the vacuum connection is properly made (→ [1], [2], "Vacuum Connection").

Sensor Cable Connection

- If no sensor cable is available, make one according to the diagram shown in the BCG450-PN section (identical).
- Connect the sensor cable to the gauge and secure the sensor cable connector using the lock screws.

Profinet Cable Connection

- If no Ethernet cables are available, make two according to the following indications:

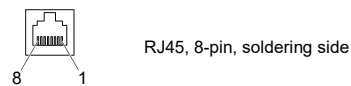

Pin 1	TD+	Transmission Data +
Pin 2	TD-	Transmission Data -
Pin 3	RD+	Receive Data +
Pin 4	not used	
Pin 5	not used	
Pin 6	RD-	Receive Data -
Pin 7	not used	
Pin 8	not used	

- Connect the Ethernet cables to the gauge: From the previous device the cable connected to the OUT port has to be connected to the BCG450-PN <IN> port. And the cable from the BCG450-PN <OUT> port has to be connected to the next device's <IN> port.

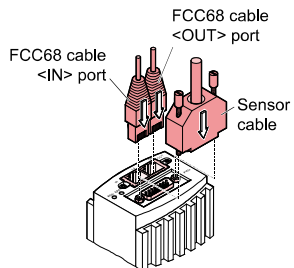

Operation

Caution

Caution: data transmission errors

If the gauge is operated via an RS232 interface and the Profinet at the same time, data transmission errors may occur.

The gauge must not be operated via an RS232 interface and the Profinet at the same time.

Operating Software

For operating the gauge via Profinet, prior installation of the device specific GSDML file is required on the bus master side. This file can be downloaded from our website.

Adjusting the Gauge

→ Adjustment and settings.

Adjusting the Switching Functions

→ "Adjustment and settings".

BCG450-SP

General Information

The BCG450-SP gauge has a fieldbus interface that conforms to the Profibus DPV1 standard (→ [12]).

Via this interface, the following and further data are exchanged in the standardized Profibus protocol (→ [4], [12]):

- Pressure reading
- Pressure unit (mbar, Torr, Pa)
- Degas function
- Status and error messages

Two adjustable switching functions are integrated in the gauge. With the built-in atmosphere switching function an atmospheric pressure threshold can be programmed (→ [2]). The corresponding relay contacts are available at the sensor cable connector.

The basic sensor and sensor electronics of the BCG450-SP type are the same as in the standard BCG450 (→ [1], [2]).

Technical Data BCG450-SP

General technical data of the sensor and sensor electronics → [1], [2].

Fieldbus Interface

Fieldbus name	Profibus
Standard applied	→ [12]
Communication protocol, data format	→ [4], [12]
Interface, physical	RS485

Profibus Parameters	
Data rate	≤12 Mbaud (→ [4], [12])
Node address	00 ... 7D _{hex} (0 ... 125 _{dec}) (default 5C _{hex})

Profibus connection	D-sub, 9-pin, female
Cable	Shielded special Profibus cable (→ [10], [12])
Cable length, system wiring	According to Profibus specifications (→ [10], [12])

Supply Voltages

Supply voltage at sensor cable connector, Pin 8	+24 V (dc) (+20 ... +28 V)
Power consumption	<20 W

Sensor Cable Connection

→ "Technical Data, Sensor Cable Connection" of the gauge BCG450-SD (identical).

Dimensions

Housing and vacuum connection → [1], [2]

Weight	
353-554	≈445 g
353-556	≈710 g

Power Connection

Sensor Cable Connection

Make sure the vacuum connection is properly made (→ [1], [2], "Vacuum Connection").

- If no sensor cable is available, make one according to the diagram shown in the BCG450-SD section (identical).
- Connect the sensor cable to the gauge and secure the sensor cable connector using the lock screws.

Profibus Cable Connection

- If no Profibus cable is available, make one according to the following indications:

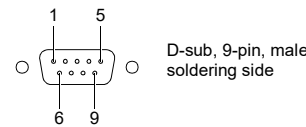

Pin 1	do not connect
Pin 2	do not connect
Pin 3	RxD/TxD-P
Pin 4	CNTR-P
Pin 5	DGND
Pin 6	VP
Pin 7	not connected internally
Pin 8	RxD/TxD-N
Pin 9	not connected internally

- Only to be connected if an *optical link* module is used.
- Only required as line termination for devices at both ends of bus cable (→ [12]).

- Connect the Profibus cable to the gauge and secure the Profibus cable connector using the lock screws.

Operation

Caution

Caution: data transmission errors

The attempt to operate the BPG450-SP with the RS232C interface causes data transmission errors.

The BPG450-SD must not be operated with the RS232C interface.

Operating Software

For operating the gauge via the Profibus network, prior installation of the gauge specific GSD file is required. This software can be downloaded via internet (→ [8]).

Note Address Setting

The node address (0 ... 125_{dec}) is set in hexadecimal form (00 ... 7D_{hex}) via the "ADDRESS", "MSD", and "LSD" switches (default 5C_{hex}). The node address is polled by the firmware when the gauge is switched on. If the setting deviates from the stored value, the new value is taken over into the NVRAM. If a value > 125_{dec} (> 7D_{hex}) is entered, the node address setting currently stored in the device remains valid but it can now be defined via Profibus ("Set slave Address", → [4]).

Adjusting the Gauge

Gauge adjustment is carried out automatically, no manual adjustment is required (adjustment of the atmosphere sensor → [2]).

Adjusting the Switching Functions

→ "Adjustment and settings".

Adjustment and Settings

For BCG450-SD, BCG450-SE and BCG450-SP gauges.

Adjusting the Gauge

The gauge is factory calibrated. If used under different climatic conditions, at extreme temperatures, through aging or contamination and after exchanging the sensor, the characteristic curve can be offset and readjustment can become necessary. However, this adjustment is carried out automatically during operation by the gauge itself. No manual adjustment is required (adjustment of the atmosphere sensor → [2]).

Setting the Switching Functions

BCG450-SD, BCG450-SP

The threshold values of switching functions A and B ¹⁾ can be set within the pressure range 1×10⁻⁹ mbar ... 100 mbar via potentiometers "SETPOINT A" and "SETPOINT B". For the corresponding threshold voltages U_{Threshold}, the following equation applies:

$$U_{\text{Threshold}} = 0.75 \times (\log p_{\text{Setpoint}} - c) + 7.75$$

Constant c depends on the pressure unit (→ [1], [2]).

¹⁾ Relays SP A/B can be reprogrammed for atmosphere switching function via fieldbus interface (→ [2]) (default switching function A/B).

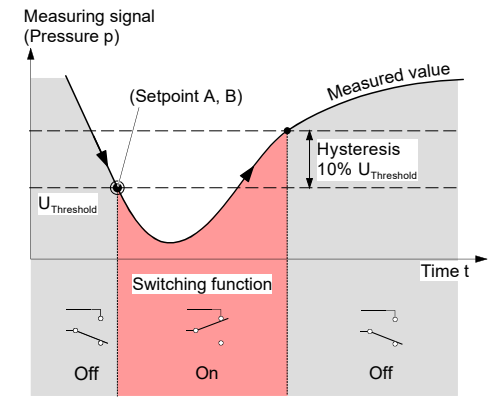

The hysteresis of the switching function is 10% of the threshold setting.

BCG450-SE

The two switching functions can be set via the EtherCAT interface only.

- Put the gauge into operation.
 - Connect the + lead of a voltmeter to the threshold measurement point of the selected switching function ("Setpoint A" Pin 3, "Setpoint B" Pin 6) and its - lead to a ground contact nearby (eg. grounded locking screw nut of connector or vacuum connection of the gauge).
- The threshold voltages are referenced to ground (housing, vacuum connection), **not** to Pin 5 (common power GND 24 V supply).

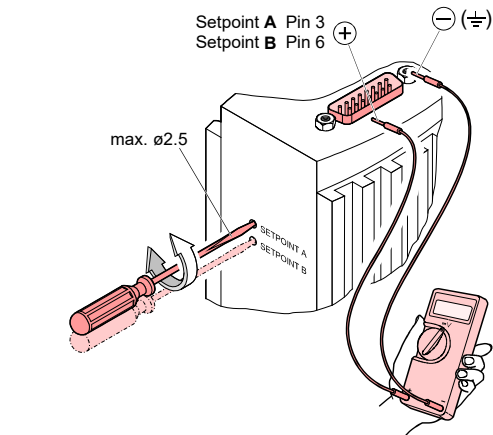

- Using a screwdriver (max. ø2.5 mm), set the threshold of the selected switching function (Setpoint A, B) to the desired value U_{Threshold}.

A functional check of the switching functions (On/Off) is only possible via fieldbus interface → [7] for BCG450-PN, (→ [3] for BCG450-SD, → [5] or [6] for BCG450-SE, → [4] for BCG450-SP) or by measuring the relay contacts with a continuity checker / ohmmeter (→ "Electrical Connection", sensor cable connector).

Further Information

- Instruction Sheet TripleGauge™ BCG450 tina40d1 / e1 German / English
- Instruction Manual TripleGauge™ BCG450, BCG450-SD, BCG450-SP tina40d1 / e1 German / English
- Communication Protocol DeviceNet™ BCG450-SD tira40e1 English
- Communication Protocol Profibus BCG450-SP tira41d1 / e1 German / English
- Communication Protocol EtherCAT BCG450-SE (ETG.5003.2080 S (R) V1.0.0) tira87e1 (English only)
- Communication Protocol EtherCAT BPG402-SE (ETG.5003.2080 S (R) V1.3.0) tirb52e1 (English only)
- Communication Protocol Profinet BCG450-PN tirb61e1 (English only)
- www.inficon.com ("Semiconductor and Vacuum coating processes, Vacuum Gauges") Product descriptions and downloads INFICON AG, LI-9496 Balzers, Liechtenstein
- www.odva.org Open DeviceNet Vendor Association, Inc. "DeviceNet™ Specifications"
- www.profibus.com Profibus user organization
- European Standard for DeviceNet EN 50325
- European Standard for Profibus EN 50170
- ETG.5003.1 S (R) V1.0.0: Semiconductor Device Profile – Part 1: Common Device Profile (CDP)
- ETG.5003.2080 S (R) V1.0.0: Semiconductor Device Profile – Part 2080: Specific Device Profile (SDP): Vacuum Pressure Gauge
- ETG.5003.1 S (R) V1.1.0: Semiconductor Device Profile – Part 1: Common Device Profile (CDP)
- ETG.5003.2080 S (R) V1.3.0: Semiconductor Device Profile – Part 2080: Specific Device Profile (SDP): Vacuum Pressure Gauge