

# Capacitance Diaphragm Gauge





## CDG025D-X3



**Operating Manual**  
Incl. EU Declaration of Conformity  
Further languages under [www.inficon.com](http://www.inficon.com)

## Product Identification

In all communications with INFICON, please specify the information given on the product nameplate. For convenient reference copy that information into the space provided below.

INFICON AG, LI-9496 Balzers		 
Model: .....		
PN: .....		 
SN: .....		
..... V	..... W	3103457

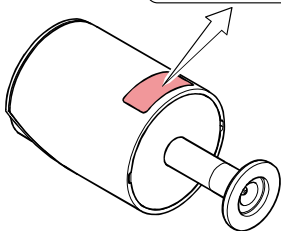

## Validity

This document applies to products of the CDG025D, X3 series.

Part numbers of standard products are indicated below. OEM products have other part numbers and different parameter settings (e.g. factory setting of setpoint) as defined in the corresponding ordering information.

### 3CB1-xxx-230x

	0 ⇒ Standard
	B ⇒ P control
Flange	1 ⇒ DN 16 ISO-KF
	3 ⇒ DN 16 CF-R
	9 ⇒ 1/2" tube
	E ⇒ 8VCR female
Unit	5 ⇒ Torr (x 133 Pa; x 1.3 mbar)
	6 ⇒ mbar (x 100 Pa)
Measurement range (F.S.)	3 ⇒ 0.1
	4 ⇒ 0.25
	5 ⇒ 0.5
	6 ⇒ 1
	7 ⇒ 2
	8 ⇒ 5
	9 ⇒ 10
	A ⇒ 20
	B ⇒ 50
	C ⇒ 100
	D ⇒ 200
	E ⇒ 500
	F ⇒ 1000 (Torr only)
	G ⇒ 1100 (mbar only)

The part number (PN) can be taken from the product nameplate.

If not indicated otherwise in the legends, the illustrations in this document correspond to gauges with the DN 16 ISO-KF vacuum connection. They apply to other vacuum connections by analogy.

We reserve the right to make technical changes without prior notice. All dimensions in mm.

## Intended Use

The Capacitance Diaphragm Gauges of the CDG025D X3 series are intended for absolute pressure measurement of gases in their respective pressure ranges (→  3). They are clean room compliant and double protected against contamination.

The gauges belong to the SKY<sup>®</sup> Smart Sensors family and can be operated in connection with an INFICON Vacuum Gauge Controller (VGC series) or another appropriate measuring unit.

## Function

The Capacitance Diaphragm Gauge consists of a capacitive sensor element made of aluminum oxide ceramics and electronics which convert the capacitance into a DC voltage output signal.

The output signal is linear to the measured pressure and independent of the gas type.

## Trademarks

SKY<sup>®</sup>    INFICON GmbH  
VCR<sup>®</sup>    Swagelok Marketing Co.

## Patents



EP 1070239 B1, 1040333 B1  
US Patents 6528008, 6591687, 7107855, 7140085

## Scope of Delivery

- 1× gauge in clean room packaging
- 1× pin for adjusting settings via buttons
- 1× Calibration Test Report
- 1× Operating Manual German
- 1× Operating Manual English

## Contents

Product Identification	2
Validity	3
Intended Use	4
Function	4
Trademarks	4
Patents	4
Scope of Delivery	4
<b>1 Safety</b>	<b>6</b>
1.1 Symbols Used	6
1.2 Personnel Qualifications	6
1.3 General Safety Instructions	7
1.4 Liability and Warranty	7
<b>2 Technical Data</b>	<b>8</b>
<b>3 Installation</b>	<b>13</b>
3.1 Vacuum Connection	13
3.2 Electrical Connection	16
<b>4 Operation</b>	<b>18</b>
4.1 Displays	18
4.2 Zeroing the Gauge	19
4.2.1 <ZERO> Adjustment	20
4.3 Switching Functions	23
4.4 Activating the Factory Setting (Factory Reset)	26
<b>5 Deinstallation</b>	<b>27</b>
<b>6 Maintenance, Repair</b>	<b>29</b>
<b>7 Returning the Product</b>	<b>29</b>
<b>8 Disposal</b>	<b>30</b>
<b>Further Information</b>	<b>31</b>
<b>ETL Certification</b>	<b>32</b>
<b>EU Declaration of Conformity</b>	<b>33</b>

For cross-references within this document, the symbol (→  XY) is used, for cross-references to further documents, listed under "Further Information", the symbol (→  [Z]).

# 1 Safety

## 1.1 Symbols Used



Information on preventing any kind of physical injury.



Information on preventing extensive equipment and environmental damage.



Information on correct handling or use. Disregard can lead to malfunctions or minor equipment damage.



Notice

## 1.2 Personnel Qualifications



All work described in this document may only be carried out by persons who have suitable technical training and the necessary experience or who have been instructed by the end-user of the product.

### 1.3 General Safety Instructions

- Adhere to the applicable regulations and take the necessary precautions for the process media used.  
Consider possible reactions with the product materials.
- Adhere to the applicable regulations and take the necessary precautions for all work you are going to do and consider the safety instructions in this document.
- Before beginning to work, find out whether any vacuum components are contaminated. Adhere to the relevant regulations and take the necessary precautions when handling contaminated parts.

Communicate the safety instructions to all other users.

### 1.4 Liability and Warranty

INFICON assumes no liability and the warranty becomes null and void if the end-user or third parties

- disregard the information in this document
- use the product in a non-conforming manner
- make any kind of interventions (modifications, alterations etc.) on the product
- use the product with accessories not listed in the product documentation.

The end-user assumes the responsibility in conjunction with the process media used.

Gauge failures due to contamination are not covered by the warranty.

## 2 Technical Data

Measurement range	→ "Validity"
Accuracy <sup>1)</sup>	
≥1 Torr/mbar (F.S.)	0.20% of reading
0.25 Torr/mbar (F.S.)	0.25% of reading
0.1 Torr/mbar (F.S.)	0.50% of reading
Temperature effect on zero	
≥10 Torr/mbar (F.S.)	0.0050% F.S./ °C
1 / 2 Torr/mbar (F.S.)	0.015% F.S./ °C
0.1 / 0.25 Torr/mbar (F.S.)	0.020% F.S./ °C
Temperature effect on span	
≥1 Torr/mbar (F.S.)	0.01% of reading / °C
0.1 / 0.25 Torr/mbar (F.S.)	0.03% of reading / °C
Resolution	0.003% F.S.
Gas type dependence	none
<hr/>	
Output signal analog (measuring signal)	
Voltage range	-5 ... +10.24 V
Measuring range	0 ... +10 V
Relationship voltage-pressure	linear
Output impedance	0 Ω (short-circuit proof)
Loaded impedance	>10 kΩ
Response time	
≥0.25 Torr/mbar (F.S.)	30 ms
0.1 Torr/mbar (F.S.)	130 ms
<hr/>	
Gauge identification	Resistance 13.2 kΩ refer- enced to supply common (Voltage at pin 10 ≤5 V)
<hr/>	

<sup>1)</sup> Non-linearity, hysteresis, repeatability in the calibrated range at 25 °C ambient operating temperature without temperature effects after operation of 2 h.





Switching functions	SP1, SP2
Setting range	0 ... +10 V
Hysteresis	1% F.S.
Relay contact	30 V (dc) / ≤0.5 A (dc) floating (n.o.)
closed	at low pressure (LED is lit)
open	at high pressure (LED is off)
Switching time	≤50 ms

RS232C interface	
Transmission rate	9600 baud
Data format	binary 8 data bits one stop bit no parity bit no handshake
Connection	→ "Electrical Connection"

Further information about the RS232C interface →  [5]

### Supply

DANGER



The gauge may only be connected to power supplies, instruments or control devices that conform to the requirements of a grounded protective extra-low voltage (PELV) and limited power source (LPS), Class 2. The connection to the gauge has to be fused <sup>2)</sup>.

Supply voltage at the gauge	+14 ... +30 V (dc) Class 2 / LPS
ripple	≤1 V <sub>pp</sub>

<sup>2)</sup> INFICON controllers fulfill this requirement.

Current consumption	<500 mA (max. starting current)
Power consumption (depending on supply voltage)	≤1 W
Fuse required <sup>2)</sup>	1 AT (slow), automatic reset (Polyfuse)
The gauge is protected against reverse polarity of the supply voltage.	

---

Electrical connection	15-pin D-Sub, male
Sensor cable	
without switching functions	5-pin plus shielding
with switching functions	9-pin plus shielding
Cable length	≤100 m (0.14 mm <sup>2</sup> conductor)
For longer cables, larger conductor cross-sections are required ( $R_{\text{cable}} \leq 1.0 \Omega$ ).	

---

Grounding concept	
Vacuum flange - signal common	→ "Electrical Connection"
Supply common - signal common	conducted separately; for differential measurement (10 $\Omega$ )

---

Materials exposed to vacuum	
Flange, tube	stainless steel AISI 316L
Sensor and diaphragm	ceramics (Al <sub>2</sub> O <sub>3</sub> ≥99.5%)
Internal volume	≤3.6 cm <sup>3</sup>
Admissible pressure (absolute)	
≥200 Torr/mbar (F.S.)	4 bar   400 kPa
1 ... 100 Torr/mbar (F.S.)	2.6 bar   260 kPa
0.1 / 0.25 Torr/mbar (F.S.)	1.3 bar   130 kPa
Bursting pressure (absolute)	5 bar   500 kPa

---

### Admissible temperatures

Storage

-40 °C ... +65 °C

Operation

+5 °C ... +50 °C

Bakeout (not in operation)

≤110 °C at the flange

Relative humidity

≤80% at temperatures  
≤+31 °C decreasing to 50%  
at +40 °C

Use

indoors only, altitude up to  
2000 m NN

Degree of protection

IP 30

### Dimensions [mm]

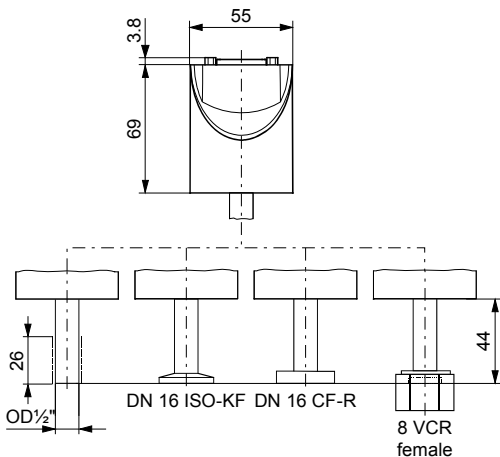

Weight

≤370 g

## Analog Measuring Signal vs. Pressure

Pressure p

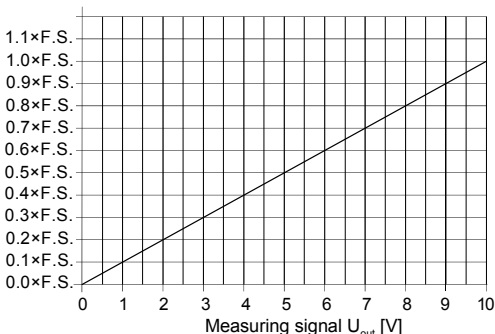

$$p = (U_{out} / 10 \text{ V}) \times p (\text{F.S.})$$

Conversion Torr  $\leftrightarrow$  Pascal

	Torr	mbar <sup>3)</sup>	Pa <sup>3)</sup>
c	1.00	$1013.25 / 760 =$ 1.3332...	$101325 / 760 =$ 133.3224...

Example: Gauge with 10 Torr F.S.  
Measuring signal  $U_{out} = 6 \text{ V}$

$$p = (6 \text{ V} / 10 \text{ V}) \times 10 \text{ Torr}$$

$$= 0.6 \times 10 \text{ Torr} = \mathbf{6 \text{ Torr}}$$

<sup>3)</sup> Source: NPL (National Physical Laboratory)  
Guide to the Measurement of Pressure and Vacuum, ISBN 0904457x /  
1998

## 3 Installation



### WARNING



WARNING: fragile components

The ceramic sensor may be damaged by impacts.

Do not drop the product and prevent shocks and impacts.

### 3.1 Vacuum Connection



### DANGER



DANGER: overpressure in the vacuum system  
>1 bar

Injury caused by released parts and harm caused by escaping process gases can result if clamps are opened while the vacuum system is pressurized.

Do not open any clamps while the vacuum system is pressurized. Use the type clamps which are suited to overpressure.



### DANGER



DANGER: overpressure in the vacuum system  
>2.5 bar

KF flange connections with elastomer seals (e.g. O-rings) cannot withstand such pressures. Process media can thus leak and possibly damage your health.

Use O-rings provided with an outer centering ring.



## DANGER



**DANGER: protective ground**

Products that are not correctly connected to ground can be extremely hazardous in the event of a fault.

Electrically connect the gauge to the grounded vacuum chamber. This connection must conform to the requirements of a protective connection according to EN 61010:

- CF and VCR flanges fulfill this requirement.
- For gauges with a KF flange, use a conductive metallic clamping ring.
- For gauges with a 1/2" tube, take appropriate measures to fulfill this requirement.



## Caution



**Caution: vacuum component**

Dirt and damages impair the function of the vacuum component.

When handling vacuum components, take appropriate measures to ensure cleanliness and prevent damages.



## Caution



**Caution: dirt sensitive area**

Touching the product or parts thereof with bare hands increases the desorption rate.

Always wear clean, lint-free gloves and use clean tools when working in this area.



Mount the gauge so that no vibrations occur. The gauge may be mounted in any orientation. To keep condensates and particles from getting into the measuring chamber preferably choose a horizontal to upright position and possibly use a seal with a centering ring and filter. If adjustment should be possible after the gauge has been installed, be sure to install it so that the buttons can be accessed with a pin (→  19).

Remove the protective lid and connect the product to the vacuum system.

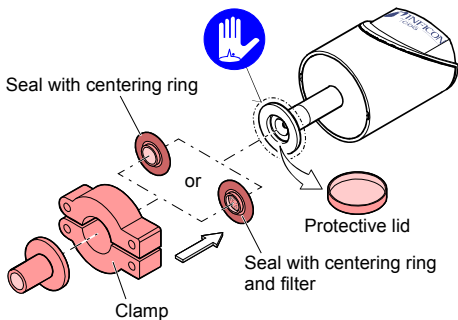

Keep the protective lid.

## 3.2 Electrical Connection



Make sure the vacuum connection is properly made (→ 13).



**DANGER**

The gauge may only be connected to power supplies, instruments or control devices that conform to the requirements of a grounded protective extra-low voltage (PELV) and limited power source (LPS), Class 2. The connection to the gauge has to be fused <sup>4)</sup>.



Ground loops, differences of potential, or EMC problems may affect the measurement signal. For optimum signal quality, please do observe the following notes:

- Connect the cable shield to ground on one side via the chassis ground. Do not connect the other side of the shield.
- Connect the supply common with protective ground directly at the power supply.
- Use differential measurement input (signal common and supply common conducted separately).
- Potential difference between supply common and housing  $\leq 18$  V (overvoltage protection).

---

<sup>4)</sup> INFICON controllers fulfill this requirement.



- 1** If no sensor cable is available, make one according to the following diagram.

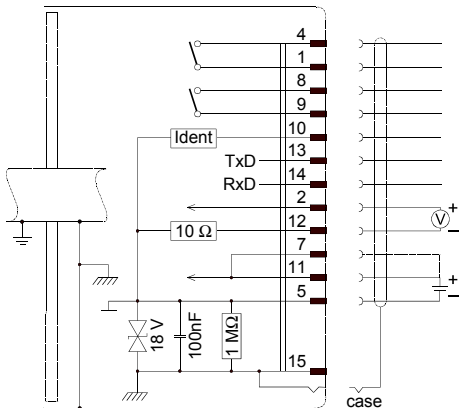

#### Electrical connection

Pin 1, 4	Relay SP1, closing contact
Pin 2	Signal output (measuring signal) or thresholds SP1/2
Pin 5	Supply common, GND
Pin 7, 11	Supply
Pin 8, 9	Relay SP2, closing contact
Pin 10	Gauge identification
Pin 12	Signal common
Pin 13	RS232, TxD
Pin 14	RS232, RxD
Pin 15	Housing (Chassis Ground)
case	Connector case

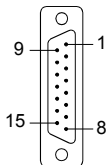

D-Sub, 15-pin female soldering side

- 2** Connect the sensor cable to the gauge and secure it using the lock screws.
- 3** Connect the sensor cable to the controller.

## 4 Operation

Put the gauge into operation. If you are using an INFICON controller of the VGC40x series, define the measurement range (→ [1, 2, 3]).

Warm-up time

- for general purpose reading (within specifications) >¼ hour
- for zero adjustment and precision measurement >2 hours

### 4.1 Displays

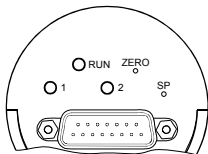

LED	State	Meaning
<RUN>	lit	Measurement mode
	flashing	Other mode (→ chapter 4.2), warning, over- / underrange, error
<1>	lit	$p \leq$ setpoint level 1
	flashing	Adjusting setpoint <1>
<2>	lit	$p \leq$ setpoint level 2
	flashing	Adjusting setpoint <2>

## 4.2 Zeroing the Gauge

The gauge is factory calibrated while "standing upright" (→ "Calibration Test Report").

 We recommend performing a zero adjustment, when the gauge is operated for the first time.

Due to long time operation or contamination, a zero drift could occur and zero adjustment may become necessary.

For adjusting the zero, operate the gauge under the same constant ambient conditions and in the same mounting orientation as normally.

The output signal (measuring signal) is depending on the mounting orientation. The signal difference between the vertical and horizontal mounting orientation is:

F.S.	$\Delta U / 90^\circ$
1000 Torr/mbar	$\approx 2 \text{ mV}$
100 Torr/mbar	$\approx 10 \text{ mV}$
10 Torr/mbar	$\approx 50 \text{ mV}$
1 Torr/mbar	$\approx 300 \text{ mV}$
0.1 Torr/mbar	$\approx 1.8 \text{ V}$

 If the gauge is operated via a controller, the zero of the whole measuring system has to be adjusted on the controller: first, adjust the zero of the gauge and then, the zero of the controller.

## 4.2.1 <ZERO> Adjustment



The zero can be adjusted via

- the <ZERO> button on the gauge,
- the RS232C interface (→  [5]),
- an INFICON Vacuum Gauge Controller (VGC series).



Evacuate the gauge to a pressure according to the table below:

F.S.	Recommended final pressure for zero adjustment		
1100 mbar	-	$<7 \times 10^0$ Pa	$<7 \times 10^{-2}$ mbar
1000 Torr	$<5 \times 10^{-2}$ Torr	$<7 \times 10^0$ Pa	-
200 Torr/mbar	$<10^{-2}$ Torr	$<1 \times 10^{-0}$ Pa	$<1 \times 10^{-2}$ mbar
100 Torr/mbar	$<5 \times 10^{-3}$ Torr	$<7 \times 10^{-1}$ Pa	$<7 \times 10^{-3}$ mbar
20 Torr/mbar	$<10^{-3}$ Torr	$<1 \times 10^{-1}$ Pa	$<1 \times 10^{-3}$ mbar
10 Torr/mbar	$<5 \times 10^{-4}$ Torr	$<7 \times 10^{-2}$ Pa	$<7 \times 10^{-4}$ mbar
2 Torr/mbar	$<10^{-4}$ Torr	$<1 \times 10^{-2}$ Pa	$<1 \times 10^{-4}$ mbar
1 Torr/mbar	$<5 \times 10^{-5}$ Torr	$<7 \times 10^{-3}$ Pa	$<7 \times 10^{-5}$ mbar
0.25 Torr/mbar	$<10^{-5}$ Torr	$<1 \times 10^{-3}$ Pa	$<1 \times 10^{-5}$ mbar
0.1 Torr/mbar	$<5 \times 10^{-6}$ Torr	$<7 \times 10^{-4}$ Pa	$<7 \times 10^{-6}$ mbar

If the final pressure in the gauge is too high for zero adjustment ( $>25\%$  of the F.S.), the zero cannot be reached and the <RUN> LED flashes. If this is the case, activate the factory setting and adjust the zero again (→  26).



Operate the gauge for at least 2 hours (until the signal is stable).

- 3** Briefly press the <ZERO> button with a pin (max.  $\varnothing 1.1$  mm). The zero adjustment runs automatically. The <STATUS> LED flashes until the adjustment (duration  $\leq 8$  s) is completed.

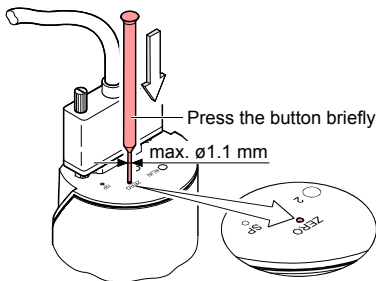

-  After zero adjustment the gauge automatically returns to measurement mode.

The <RUN> LED flashes if

- the signal output is negative ( $< -20$  mV) when the final pressure has been attained
- the zero adjustment has failed.

#### 4.2.2 <ZERO> Adjustment with Ramp Function

The ramp function allows to adjust the zero at a known reference pressure within the measurement range of the gauge.

It also permits to adjust an offset of the characteristic curve in order to

- compensate for the offset of the measuring system or
- obtain a slightly positive zero for a 0 ... 10 V AD converter.

The offset should not exceed 2% of the F.S. (+200 mV). At a higher positive offset, the upper limit of the measurement range is exceeded.



Recommended procedure for adjusting the offset of a measuring system: → Notice  19.

- 1** Operate the gauge for at least 2 hours (until the signal is stable).
- 2** Push the <ZERO> button with a pin (max.  $\varnothing 1.1$  mm) and keep it depressed. The <RUN> LED starts flashing. After 5 s, the zero adjustment value, starting at the current output value, keeps continually changing (ramp) until the button is released or until the setting limit (max. 25% F.S.) is reached. The corresponding output signal is delayed by about 1 s.

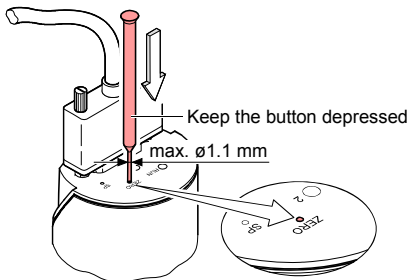

**3** Push the <ZERO> button again:

Fine adjustment within 0...3 s:	the zero adjustment value changes by one unit (push <ZERO> button in intervals of 1 s)
Change of direction within 3...5 s:	the zero adjustment changes its direction (the flashing frequency of the <RUN> LED changes briefly)



If the <ZERO> button is released for more than 5 s, the gauge returns to the measurement mode.

The <RUN> LED flashes if the signal output is negative (< -20 mV).

## 4.3 Switching Functions

The two switching functions can be adjusted to any pressure within the whole measurement range (→  12).

The current setpoint setting

- is output at the D-Sub connector instead of the measurement signal (→  17) and can be measured with a voltmeter after the <SP> button is pressed, or
- can be read/written via the RS232C interface.

If the pressure is lower than the setpoint, the corresponding LED is lit (<1> or <2>) and the corresponding relay (→ 17) is energized.

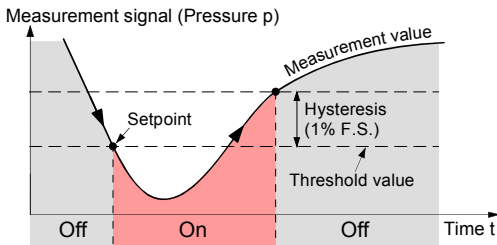

#### 4.3.1 Adjusting the Setpoints



The setpoints can be adjusted via

- the buttons on the gauge,
- the RS232C interface (→ [5]).



**DANGER**

**DANGER: malfunction**

If processes are controlled via the signal output, keep in mind that by pushing the <SP> button the measurement signal is suppressed and the corresponding threshold value is output instead. This can cause malfunctions.

Push the <SP> button only if you are sure that no malfunction cause.



## Adjusting Setpoint <1>

- 1** Push the <SP> button with a pin (max.  $\varnothing 1.1$  mm). The gauge changes to the switching function mode and outputs the current lower threshold value at the measurement value output for about 10 s (LED <1> flashes).

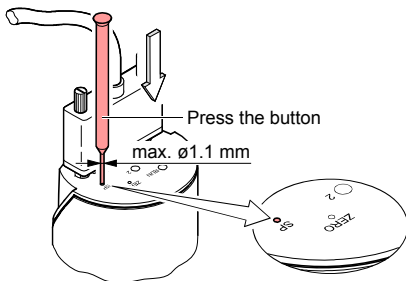

- 2** For changing the threshold value, push the <ZERO> button and keep it depressed. The threshold keeps changing from the current value (ramp) until the button is released or until the limit of the setting range is reached.

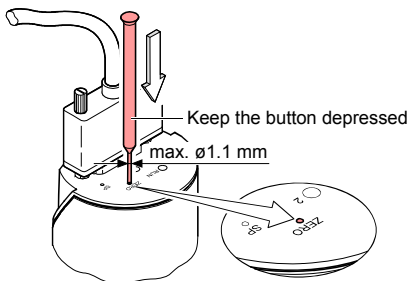

- 3** Push the <ZERO> button again:

Fine adjustment within 0...3 s:	the zero adjustment value changes by one unit
Change of direction within 3...5 s:	the zero adjustment changes its direction (the flashing frequency of the <RUN> LED changes briefly)



If the <ZERO> button is released for more than 5 s, the gauge returns the measurement mode.



The upper threshold is automatically set 1% F.S. above the lower one (hysteresis).

### Adjusting Setpoint <2>

Push the <SP> button twice (LED <2> flashes). The adjustment procedure is the same as for setpoint <1>.

## 4.4 Activating the Factory Setting (Factory Reset)

All user defined parameters (e.g. zero, filter) are restored to their default values.



Loading of the default parameters is irreversible.

Loading the default parameters:

- 1** Put the gauge out of operation.
- 2** Keep the <ZERO> button depressed for at least 5 s while the gauge is being put into operation (Power ON).

## 5 Deinstallation



### WARNING



**WARNING:** fragile components

The ceramic sensor may be damaged by impacts.

Do not drop the product and prevent shocks and impacts.



### DANGER



**DANGER:** contaminated parts

Contaminated parts can be detrimental to health and environment.

Before beginning to work, find out whether any parts are contaminated. Adhere to the relevant regulations and take the necessary precautions when handling contaminated parts.



### Caution



**Caution:** vacuum component

Dirt and damages impair the function of the vacuum component.

When handling vacuum components, take appropriate measures to ensure cleanliness and prevent damages.



### Caution



Caution: dirt sensitive area

Touching the product or parts thereof with bare hands increases the desorption rate.

Always wear clean, lint-free gloves and use clean tools when working in this area.

- ① Vent the vacuum system.
- ② Put the gauge out of operation.
- ③ Unfasten the lock screws and disconnect the sensor cable.
- ④ Remove the gauge from the vacuum system and install the protective lid.

## 6 Maintenance, Repair

Under clean operating conditions, the product requires no maintenance.



Gauge failures due to contamination are not covered by the warranty.

We recommend checking the zero at regular intervals (→  20).

INFICON assumes no liability and the warranty becomes null and void if any repair work is carried out by the end-user or third parties.

## 7 Returning the Product



### WARNING



**WARNING:** forwarding contaminated products  
Contaminated products (e.g. radioactive, toxic, caustic or microbiological hazard) can be detrimental to health and environment.

Products returned to INFICON should preferably be free of harmful substances. Adhere to the forwarding regulations of all involved countries and forwarding companies and enclose a duly completed declaration of contamination (form under [www.inficon.com](http://www.inficon.com)).

Products that are not clearly declared as "free of harmful substances" are decontaminated at the expense of the customer. Products not accompanied by a duly completed declaration of contamination are returned to the sender at his own expense.

## 8 Disposal



### DANGER



**DANGER:** contaminated parts

Contaminated parts can be detrimental to health and environment.

Before beginning to work, find out whether any parts are contaminated. Adhere to the relevant regulations and take the necessary precautions when handling contaminated parts.



### WARNING



**WARNING:** substances detrimental to the environment

Products or parts thereof (mechanical and electric components, operating fluids etc.) can be detrimental to the environment.





Dispose of such substances in accordance with the relevant local regulations.

### Separating the components

After disassembling the product, separate its components according to the following criteria:

- Contaminated components  
Contaminated components (radioactive, toxic, caustic or biological hazard etc.) must be decontaminated in accordance with the relevant national regulations, separated according to their materials, and disposed of.
- Other components  
Such components must be separated according to their materials and recycled.

## Further Information

-  [1] [www.inficon.com](http://www.inficon.com)  
 Operating Manual  
 Vacuum Gauge Controller VGC032  
 tinb02e1  
 INFICON AG, LI-9496 Balzers, Liechtenstein
-  [2] [www.inficon.com](http://www.inficon.com)  
 Operating Manual  
 Single-Channel Controller VGC401  
 tinb01e1  
 INFICON AG, LI-9496 Balzers, Liechtenstein
-  [3] [www.inficon.com](http://www.inficon.com)  
 Operating Manual  
 Two- & Three-Channel Measurement and Control Unit  
 VGC402, VGC403  
 tinb07e1  
 INFICON AG, LI-9496 Balzers, Liechtenstein
-  [4] [www.inficon.com](http://www.inficon.com)  
 Operating Manual  
 One-, Two- & Three-Channel Measurement and Control  
 Unit VGC501, VGC502, VGC503  
 tina96e1  
 INFICON AG, LI-9496 Balzers, Liechtenstein
-  [5] [www.inficon.com](http://www.inficon.com)  
 Communication Protocol  
 RS232C Interface  
 tira49e1  
 INFICON AG, LI-9496 Balzers, Liechtenstein

## ETL Certification



**Intertek**  
**3103457**

ETL LISTED

The product CDG025D

- conforms to the UL Standard  
UL 61010-1
- is certified to the CSA Standard  
CSA C22.2 # 61010-1



## EU Declaration of Conformity



We, INFICON, hereby declare that the equipment mentioned below complies with the provisions of the Directive relating to electromagnetic compatibility 2014/30/EU and the Directive on the restriction of the use of certain hazardous substances in electrical and electronic equipment 2011/65/EU.

### Capacitance Diaphragm Gauge

CDG025D-X3

#### Standards

Harmonized and international/national standards and specifications:

- EN 61000-6-2:2005 (EMC: generic immunity standard)
- EN 61000-6-3:2007 + A1:2011 (EMC: generic emission standard)
- EN 61010-1:2010 (Safety requirements for electrical equipment for measurement, control and laboratory use)
- EN 61326:2013; Group 1, Class B (EMC requirements for electrical equipment for measurement, control and laboratory use)

#### Manufacturer / Signatures

INFICON AG, Alte Landstrasse 6, LI-9496 Balzers

26 July 2016

26 July 2016

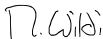
Dr. Bernhard Andreaus  
Director Product Evolution

Michael Wildi  
Product Manager

## Notes

## Notes

Original: German tina57d1-b (2016-07)



tina57d1-b



LI-9496 Balzers  
Liechtenstein  
Tel +423 / 388 3111  
Fax +423 / 388 3700  
[reachus@inficon.com](mailto:reachus@inficon.com)

[www.inficon.com](http://www.inficon.com)