



Vacuum Gauge Controller



VGC031



Operating Manual
Incl. EU Declaration of Conformity

Product Identification

In all communications with INFICON, please specify the information given on the product nameplate. For convenient reference copy that information into the space provided below.

INFICON AG, LI-9496 Balzers	 
Model:.....	
PN:.....	
SN:.....	
..... VDC; W; LPS	

Validity

This document applies to products with part number
399-570

The part number (PN) can be taken from the product nameplate. If your unit does not work as described in this document, please check that it is equipped with the above firmware version (→  30).

We reserve the right to make technical changes without prior notice.

Important User Information

There are operational characteristic differences between solid state equipment and electromechanical equipment. Because of these differences, and because there are a variety of uses for solid state equipment, all persons that apply this equipment must take every precaution and satisfy themselves that the intended application of this equipment is safe and used in an acceptable manner.

In no event will INFICON be responsible or liable for indirect or consequential damages that result from the use or application of this equipment.

Any examples or diagrams included in this manual are provided solely for illustrative purposes. Because of the many variables and requirements imposed on any particular installation, INFICON cannot assume responsibility or liability for any actual use based on the examples and diagrams.

No patent liability is assumed by INFICON with respect to use of information circuits, equipment, or software described in this manual.

Throughout this manual we use notes, notices and apply internationally recognized symbols and safety messages to make you aware of safety considerations.

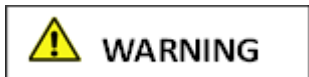

Identifies information about practices or circumstances that can cause electrical or physical hazards which, if precautions are not taken, could result in death or serious injury, property damage, or economic loss.



Identifies information about practices or circumstances that can cause electrical or physical hazards which, if precautions are not taken, could result in minor or moderate injury, property damage, or economic loss.



Identifies information that is critical for successful application and understanding of the product.



Labels may be located on or inside the device to alert people that dangerous voltages may be present.

General Safety Instructions

- Adhere to the applicable regulations and take the necessary precautions for the process media used.
Consider possible reactions with the product materials.
Consider possible reactions (e.g. explosion) of the process media due to the heat generated by the product.
- Adhere to the applicable regulations and take the necessary precautions for all work you are going to do and consider the safety instructions in this document.
- Before beginning to work, find out whether any vacuum components are contaminated. Adhere to the relevant regulations and take the necessary precautions when handling contaminated parts.

Communicate the safety instructions to all other users.

Liability and Warranty

INFICON assumes no liability and the warranty becomes null and void if the end-user or third parties

- disregard the information in this document
- use the product in a non-conforming manner
- make any kind of interventions (modifications, alterations etc.) on the product
- use the product with accessories not listed in the product documentation.

Contents

Product Identification	2
Validity	2
Important User Information	2
General Safety Instructions	5
Liability and Warranty	5
1 Introduction / General Information	8
1.1 Description	8
1.2 Specifications	9
1.3 Dimensions	11
1.4 Options & Accessories	12
2 Important Safety Information	13
2.1 Safety Precautions - General	13
2.2 Safety Precautions - Service and Operation	14
2.3 Electrical Conditions	15
2.3.1 Proper Equipment Grounding	16
2.3.2 Electrical Interface and Control	16
2.4 Overpressure and use with hazardous gases	17
2.5 Gases other than Nitrogen / air	18
3 Installation	19
3.1 Mechanical Installation - Controller	19
3.2 Electrical Installation	20
3.2.1 Grounding	20
3.2.2 Electrical Connections	20
4 Setup and Operation	24
4.1 Initial Setup	24
4.2 User Interface Basics	25
4.3 Programming	26
4.4 Return to Factory Default Settings	31
5 Using the Gauge with Different Gases	32
6 Display	35
6.1 Display - Torr / mTorr	35
6.2 Display - mbar	39

7 Analog Output	44
7.1 Log 1-8; Log-Linear Analog Output Equation & Table - Torr	48
7.2 Log 1-8; Log-Linear Analog Output Equation & Table - mbar	52
7.3 Log 0-7; Log-Linear Analog Output Equation & Table - Torr	57
7.4 Log 0-7; Log-Linear Analog Output Equation & Table - mbar	61
7.5 NONLIN 6V; Non-Linear Analog Output Equations	66
7.6 NONLIN 6V; Non-Linear Analog Output Table - Torr	68
7.7 NONLIN 6V; Non-Linear Analog Output Table - mbar	72
7.8 NONLIN 9V; Non-Linear Analog Output Equations & Table	76
7.9 LINEAR ANALOG OUTPUT	79
8 RS485 / RS232 serial communications	81
8.1 Device Specific Serial Communication Info	81
8.2 RS485 / RS232 Command Protocol Summary	82
9 Service	85
9.1 Calibration	85
9.1 Maintenance	85
9.3 Troubleshooting	86
10 Factory Service and Support	88
11 Storage	88
13 Disposal	89
EU Declaration of Conformity	90

For cross-references within this document, the symbol (→  XY) is used.

1 Introduction / General Information

1.1 Description

The VGC031 vacuum gauge controller is a convenient and inexpensive power supply and readout instrument for the INFICON PGE050 Pirani Gauge Enhanced or a Granville-Phillips® 275 Convectron®. The 1/8-DIN housing can be used as a bench top, or mounted in a cutout in an instrument panel. The VGC031 is powered by user supplied 12 to 28 V (dc), 2 W, or by the INFICON power supply.

Thermal conductivity gauges measure pressure indirectly by sensing the loss of heat from a sensor to the surrounding gases. The higher the pressure of the surrounding gas, the more heat is conducted away from the sensor. Pirani thermal conductivity gauges maintain a sensor (usually a wire) at some constant temperature, and measure the current or power required to maintain that temperature. A standard Pirani gauge has a useful measuring range of about 10^{-4} Torr to 10 Torr. By taking advantage of convection currents that are generated above 1 Torr, convection-enhanced Pirani gauges increase the measuring range to just above atmosphere.

The VGC031 signals and relay functions are the same as found on similar convection gauge controllers from other manufacturers. The VGC031 Controller, PGE050 vacuum gauge tube and gauge cable can be directly interchanged with MKS Instruments / Granville-Phillips® (GP) 375 or 475 controller, 275 Convectron® gauge and gauge cable (Remote interface, relay and power connectors are different). Various analog output scaling provide signal compatibility with GP controller series 375, 475, the original GP 1/4 DIN 275 Analog Convectron Gauge Controller as well as the Mini-Convectron® module.

1.2 Specifications

Supply voltage	12 ... 28 V (dc), 2 W protected against power reversal and transient over-voltages
Connection	2-pin pluggable terminal block (mating connector included)
Permissible temperature	
Operating	0 ... +50 °C
Storage	-40 ... +70 °C
Relative humidity	0 to 95%, non-condensing
Use	
Operating	altitude up to 2500 m (8200 ft.)
Storage	altitude up to 12500 m (41000 ft.)
Housing	1/8-DIN panel-mount enclosure (aluminum extrusion)
Connections	
Gauge	9-pin D-sub female (mating connector provided as part of the gauge cable)
Analog output and serial communications interface	9-pin D-sub male
Relay outputs	6-pin pluggable terminal block (mating connector included)
Measurement range	1.3×10 ⁻⁴ ... 1333 mbar 1×10 ⁻⁴ ... 1000 Torr 1.3×10 ⁻² Pa ... 133 kPa
Display rate	0.5 s
Units	mbar, Torr or Pa
Display	bright OLED, 4 digits
1100 Torr ... 1000 Torr	4 digits
999 Torr ... 10.0 mTorr	3 digits
9.9 mTorr ... 1.0 mTorr	2 digits
0.9 mTorr ... 0.1 mTorr	1 digit

Interface (digital) Protocol	RS232 and 2 wire/4 wire RS485 ASCII
<hr/>	
Analog output	
Log-linear	0 to 7 V (dc) or 1 to 8 V (dc), 1 V/decade
Linear	0 to 10 V (dc)
Non-linear S-curve	0.375 to 5.659 V (dc)
Non-linear S-curve	0 to 9 V (dc)
<hr/>	
Switching function relays	two single-pole double-throw relays (SPDT), 1 A at 30 V (dc) resistive, or ac non-inductive
<hr/>	

1.3 Dimensions

mm (inch)

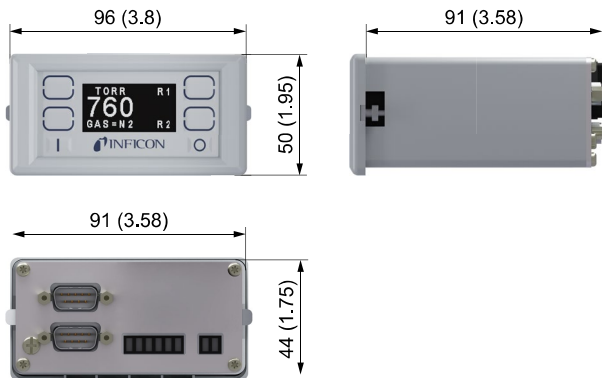

Weight

≈250 g (9 oz.)

1.4 Options & Accessories

		Ordering No.
Power supply for VGC031		399-575
		
Input	100 ... 240 V (ac), 50 ... 60 Hz	
Output	24 V (dc)	
Cable length	2 m (6 ft)	

The conventional IEC60320 AC power entry receptacle allows use with any user supplied AC mains power cord set available worldwide.

2 Important Safety Information

INFICON has designed and tested this product to provide safe and reliable service, provided it is installed and operated within the strict safety guidelines provided in this manual. **Please read and follow all warnings and instructions.**



WARNING

To avoid serious injury or death, follow the safety information in this document. Failure to comply with these safety procedures could result in serious bodily harm, including death, and or property damage.

Failure to comply with these warnings violates the safety standards of installation and intended use of this instrument. INFICON disclaims all liability for the customer's failure to comply with these instructions.

Although every attempt has been made to consider most possible installations, INFICON cannot anticipate every contingency that arises from various installations, operation, or maintenance of the module. If you have any questions about the safe installation and use of this product, please contact INFICON.

This device meets FCC part 15 requirements for an unintentional radiator, class A.

2.1 Safety Precautions - General

Hazardous voltages are present with this product during normal operation. The product should never be operated with the covers removed unless equivalent protection of the operator from accidental contact with hazardous internal voltages is provided.



WARNING! There are no operator serviceable parts or adjustments inside the product enclosure. Refer servicing to service trained personnel.

Do not modify this product or substitute any parts without authorization of qualified INFICON service trained personnel. Return the product to an INFICON qualified service and repair center to ensure that all safety features are maintained. Do not use this product if unauthorized modifications have been made.



WARNING! Source power must be removed from the product prior to performing any servicing.

After servicing this product, ensure that all safety checks are made by a qualified service person. When replacement parts are required, ensure that the parts are specified by INFICON. Substitutions of non-qualified parts may result in fire, electric shock or other hazards. Use of unauthorized parts or modifications made to this product will void the warranty.

To reduce the risk of fire or electric shock, do not expose this product to rain or moisture. These products are not waterproof and careful attention must be paid to not spill any type of liquid onto these products. Do not use these products if they have been damaged. Immediately contact INFICON to arrange return of the product if it is damaged.

Due to the possibility of corrosion when used in certain environmental conditions, it is possible that the product's safety could be compromised over time. It is important that the product be periodically inspected for sound electrical connections and equipment grounding. Do not use if the equipment grounding or electrical insulation has been compromised.

2.2 Safety Precautions - Service and Operation

Ensure the enclosure of the VGC031 is connected directly to a good quality earth ground.

Ensure that the vacuum port on which the PGE050 vacuum gauge tube is mounted is electrically grounded.

Use an appropriate power source of 12 to 28 V (dc), 2 W or use INFICON series optional power supplies.

Turn off power to the unit before attempting to service the controller.

Turn off power to the unit if a cable or plug is damaged or the product is not operating normally according to this instruction manual. Contact qualified INFICON service personnel for any service or troubleshooting condition that may not be covered by this instruction manual.

It is important that the product be periodically inspected for sound electrical connections and equipment grounding. Do not use if the equipment grounding or electrical insulation has been compromised.

Do not use if the unit has been dropped or the enclosure has been damaged. Contact INFICON for return authorization and instructions for returning the product to INFICON for evaluation.

2.3 Electrical Conditions



WARNING! When high voltage is present in any vacuum system, a life threatening electrical shock hazard may exist unless all exposed electrical conductors are maintained at earth ground potential. This applies to all products that come in contact with the gas contained in vacuum chambers. An electrical discharge within a gaseous environment may couple dangerous high voltage directly to any ungrounded conductor of electricity. A person could be seriously injured or killed by coming in contact with an exposed, ungrounded electrical conductor at high voltage potential. This condition applies to all products that may come in contact with the gas inside the vacuum chamber (vacuum / pressure containment vessel).

2.3.1 Proper Equipment Grounding



WARNING! Hazardous voltages that could seriously injure or cause death are present in many vacuum processes. Verify that the vacuum port on which the PGE050 vacuum gauge tube is mounted is electrically grounded. Consult a qualified Electrician if you are in doubt about your equipment grounding. Proper grounding of your equipment is essential for safety as well as intended operation of the equipment. The PGE050 vacuum gauge tube and enclosure of the VGC031 controller must be connected directly to a good quality earth ground. Use a ground lug on the PGE050 gauge vacuum connection / flange if necessary.



WARNING! In order to protect personnel from electric shock and bodily harm, shield all conductors which are subject to potential high voltage electrical discharges in or around the vacuum system.

2.3.2 Electrical Interface and Control

It is the user's responsibility to ensure that the electrical signals from this product and any connections made to external devices, for example, relays and solenoids, are used in a safe manner. Always double check the system set-up before using any signals to automate your process. Perform a hazardous operation analysis of your system design and ensure safeguards and personnel safety measures are taken to prevent injury and property damage.

2.4 Overpressure and use with hazardous gases



WARNING! Install suitable protective devices that will limit the level of pressure inside your vacuum chamber to less than what the vacuum chamber system components are capable of withstanding. INFICON gauges should not be used at pressures exceeding 1000 Torr absolute pressure.

In cases where an equipment failure could cause a hazardous condition, always implement fail-safe system operation. For example, use a pressure relief device in an automatic backfill operation where a malfunction could result in high internal pressures if the pressure relief device was not installed on the chamber.

The PGE050 vacuum gauge tube connected to the VGC031 controller is not intended for use at pressures above 20 psia (1000 Torr); DO NOT exceed 35 psig (<2½ bars) pressure inside the sensor. If your chamber goes to higher pressures, you should install an isolation valve or pressure relief device to protect the gauge tube from overpressure conditions. With some fittings, actual safe overpressure conditions may be lower; for example, a quick-connect, O-ring compression fitting may forcibly release the gauge tube from the vacuum chamber fitting with only a few psi over local uncorrected barometric (atmospheric) pressure.



CAUTION! If the internal pressure of a vacuum gauge device is allowed to increase above local uncorrected barometric pressure (atmospheric pressure side), vacuum fittings may release and possible overpressure conditions may cause leaks that would allow the gas inside the gauge tube to release into the atmosphere of the surrounding environment. Toxic, pyrophoric and flammable gases are examples of hazardous gases that if allowed to leak out of the vacuum/pressure containment vessel into the atmospheric environment, could cause bodily injury and possible damage to equipment. Never expose the gauge tube internal volume to pressure above local atmospheric pressure when using hazardous gases.

2.5 Gases other than Nitrogen / air



WARNING! Do not attempt to use with gases other than nitrogen (N_2) or air without referring to correction factor data tables.

INFICON gauges and modules are calibrated for direct readout of nitrogen or air. Do not attempt to use with other gases such as argon (Ar) or carbon dioxide (CO_2) unless accurate conversion data for N_2 to other gas is properly used. Refer to sections titled "Using the gauge with different gases", "Display" and "Analog Output" for a more complete discussion.



WARNING! Do not use the convection gauge connected to this device in an explosive atmosphere or in the presence of flammable gases, vapors or fumes. Do not use this device to measure the pressure of explosive or combustible gases or gas mixtures. The sensor wire in the gauge normally operates at $125\text{ }^\circ\text{C}$, but if malfunction should occur, the wire temperature could exceed the ignition temperature of certain combustible gases and gas mixture. This could cause an explosion which could result in serious injury or death.

3 Installation

3.1 Mechanical Installation - Controller

The VGC031 is designed for use on a bench top, or it may be mounted in an instrument control panel.

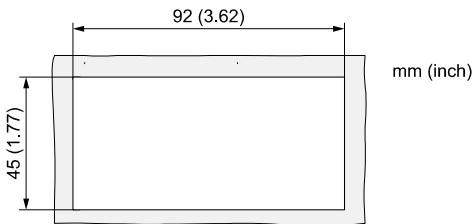

To mount the VGC031 in a panel:

1. Make a cutout in your instrument control panel as shown in the drawing above. Be sure to allow clearance behind the panel for the instrument as well as connectors and cables at the rear of the instrument
2. Gently pry the front panel bezel loose and remove.



3. Slide the VGC031 into the panel hole cutout.
4. On either side of the VGC031 are two screw-mounting brackets. When the screws in the front of the instrument are turned counterclockwise, the hold-down brackets recess out of the way into the VGC031 housing. When these screws are turned clockwise, the brackets rotate out 90° behind the panel. Tighten these screws until the brackets hold the VGC031 in place against the panel.
5. Press the front panel bezel back in place.

3.2 Electrical Installation

3.2.1 Grounding



Be sure the vacuum gauge and your vacuum system are properly grounded to protect personnel from shock and injury. Be aware that some vacuum fittings, especially those with O-rings, may not produce a good electrical connection between the gauge and the chamber it is connected to.

3.2.2 Electrical Connections

A good recommended practice is to remove power from any cable prior to connecting or disconnecting it.

The INFICON VGC031 may replace similar controllers from other manufacturers, such as the Granville-Phillips® 375 controller. Many of these other controllers employ the same 9-pin and 15-pin D connectors, but they do not all use the same signal / pinout configurations. If you wish to use your existing cables, be sure to check compatibility with the tables on the next page. Rewire your cables as necessary.

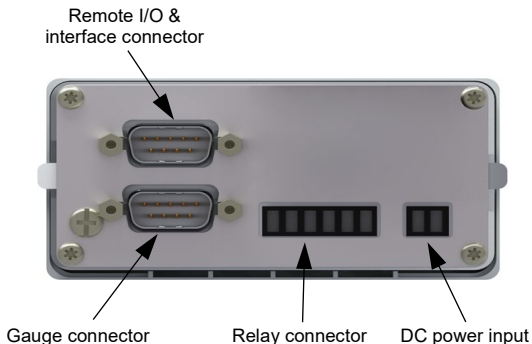

DC Power Input

The VGC031 accepts DC power from 12 to 28 V (dc), 2 W. If the user prefers to use AC power, INFICON offers the series optional power supplies.

2-pin pluggable terminal strip

(Mating connector included and shipped with device (Phoenix p/n 1803578))

Pin no.	Pin description
1	+12 ... +28 V (dc)
2	Power ground

Remote I/O & Interface Connector

The 9-Pin D-sub connector is used for analog output and serial communications. Please note the following:

- 1) When using RS232 or RS485 serial communications, you must fabricate your own cable according to the 9-pin D-Sub pinout shown below. A standard off-the-shelf serial communications cable will not work.

- 2) The relays are disabled by applying a continuous ground to pin # 9. This will prevent any switching of the relay contactors during operation of the VGC031.

9-pin D-sub male (Mating connector provided by user).

Pin no.	Pin description 4 Wire RS485	Pin description 2 Wire RS485
1	RS485 RDA (-) Input	RS485 DATA A (-) Input/output
2	RS485 RDB (+) Input	RS485 DATA B (+) Input / output
3	RS485 TDA (-) Output	
4	RS485 TDB (+) Output	
5	RS232 TX When using RS232 serial comm., this pin is typically connected to pin #2 of your PC serial port 9-pin D-sub connector	RS232 TX When using RS232 serial comm., this pin is typically connected to pin #2 of your PC serial port 9-pin D-sub connector
6	RS232 RX When using RS232 serial comm., this pin is typically connected to pin #3 of your PC serial port 9-pin D-sub connector	RS232 RX When using RS232 serial comm., this pin is typically connected to pin #3 of your PC serial port 9-pin D-sub connector
7	analog output signal (non-linear, linear, or log-linear)	analog output signal (non-linear, linear, or log-linear)
8	analog output signal ground Also when using serial comm., this pin is typically connected to pin # 5 of your PC RS232 serial port 9-pin D-sub connector, or ground pin of your RS485 converter	analog output signal ground Also when using serial comm., this pin is typically connected to pin # 5 of your PC RS232 serial port 9-pin D-sub connector, or ground pin of your RS485 converter
9	relay disable The relays are disabled by applying a continuous ground	relay disable The relays are disabled by applying a continuous ground

Relay Connector

There are two single-pole double-throw relays (SPDT), rated at 1 A at 30 V (dc) resistive, or ac non-inductive.

6-pin pluggable terminal strip
 (Mating connector included and shipped with device (Phoenix
 p/n 1803617))

Pin no.	Pin description
1	relay 1 common
2	relay 1 NC
3	relay 1 NO
4	relay 2 common
5	relay 2 NC
6	relay 2 NO

Gauge Cable Assembly

P/Ns 399-580, 399-581 and 399-583 are custom cable assemblies provided in different lengths from INFICON for connecting the VGC031 controller to INFICON PGE050 Pirani Gauge Enhanced or MKS Instruments / Granville-Phillips® 275 Convec-tron® vacuum gauge sensor. The cable pin to pin connection is shown below.

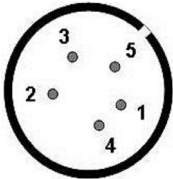
VGC031	connects to	PGE050	PGE050 connector
Pin 1		no connection	
Pin 2		cable shield	
Pin 3		Pin 3	
Pin 4		Pin 3	
Pin 5		Pin 2	
Pin 6		Pin 5	
Pin 7		Pin 1	
Pin 8		Pin 1	
Pin 9		no connection	

4 Setup and Operation

4.1 Initial Setup

Two of the most important steps for the initial setup of the gauge are to set zero (SET VAC) and set atmosphere (SET ATM) as described in the Programming section 4.3 below. This will ensure proper operation of the gauge and accurate pressure measurements. The gauge is calibrated at the factory using nitrogen. Furthermore, the gauge is also installed in a certain orientation when calibrated at the factory. Without setting zero and atmosphere after the gauge is installed in your system, the gauge may not display the expected and correct pressures. This could be caused by the fact that you may be using a different gas than Nitrogen such as air to setup and calibrate the gauge (most commonly the case) and the gauge orientation is different than the orientation used at the factory. As such, it is very important to perform your own initial setup and calibration by setting zero and atmosphere with the gauge installed in your actual system. Please note the following:

Setting zero (SET VAC)

Setting atmosphere is the most important step for a newly installed gauge. If you prefer to use air to set atmosphere, vent your vacuum system chamber to expose the gauge to the local atmospheric pressure (air) and set atmosphere to match your known local uncorrected barometric pressure (air). This is the reading of ambient air pressure you will expect if you were to vent and open your vacuum chamber to the atmosphere surrounding the outside of your chamber. At sea level, this pressure is usually near 760 Torr. At elevations above sea level, the pressure decreases. Check your local aviation authority or airport web sites or your current local weather conditions online to help find your local uncorrected barometric pressure if you do not have this information. See "SET ATM" in section 4.3

Setting Atmosphere (SET ATM)

Setting zero optimizes performance of the gauge when operating at a low pressure range of 1.00×10^{-4} Torr to 1.00×10^{-3} Torr. If your minimum operating pressure is higher than 1.00×10^{-3} Torr, it is not normally necessary to set zero and thus setting atmosphere should be adequate. If you are able to evacuate your system to below 1.00×10^{-4} Torr, it is always a good practice to check and set zero if necessary. See "SET VAC" in section 4.3

Note - Setting zero and atmosphere is normally required only once during the initial setup and maybe checked by the user periodically. After power has been applied to the gauge during the initial setup, allow five minutes for the gauge to stabilize (warm-up) before setting zero and atmosphere.

4.2 User Interface Basics

The user interface is designed for easy operation and a natural progression of setup parameters. This section gives a brief explanation of operation for added clarity.



Programming soft-keys

There are four soft-keys located on the front panel, two on each side of the display. These keys are used to select and program the various functions available. During programming of the VGC031, the display will identify what function each key represents. To begin programming, press any one of the four keys. The display will indicate a choice of functions. Press the key indicated by the function on the display to continue with the programming of the parameter desired. After setting the various parameters, press the SAVE key to save the new setting and return to the main screen. To continue setting additional parameters, scroll forward with the MORE key until you reach the desired parameter.

4.3 Programming

SET VAC

NOTICE

When operating in units of either mbar or pascals (Pa), you must perform SET ATM before setting the vacuum reading (SET VAC). See SET ATM below. Failure to do so will result in improper operation of the gauge. If you change units of measure or reset to factory defaults, then this same procedure must be followed again if the units of measure are being set to either mbar or Pa.

1. To properly set the vacuum reading ("zero" point), with the PGE050 installed on your vacuum system, the gauge should be evacuated to a pressure below 1.00×10^{-4} Torr.
2. Go to the SET VAC screen. When the vacuum system pressure is below 1.00×10^{-4} Torr, press the PRESS TO SET VAC key. The zero point (displayed pressure reading with gauge exposed to vacuum) is now set.

UNITS [Factory default = TORR]

This should be the first parameter that is set. This will be the units-of-measure (Torr, mbar, Pa) that are used for all other

settings. If your VGC031 has been previously configured and relay setpoints and linear analog output pressure settings have been programmed, changing units-of-measure will return the relays setpoints and the linear analog output pressure settings to factory default setting values in Torr. In this case, you must re-program the relay setpoints and linear analog output pressure settings in the newly programmed units-of-measure.

SET ATM

1. To set the atmospheric pressure reading (also known as the "span" adjustment), flow nitrogen gas or air into your closed vacuum chamber to allow the pressure to rise to a known value above 400 Torr. Alternatively, if your local uncorrected barometric pressure (air) is known, simply vent your vacuum system chamber to expose the gauge to the local atmospheric pressure.
2. Go to the SET ATM screen. When the desired pressure is stable, adjust the displayed pressure reading on the VGC031 to the known value using the INCR (increase) or DECR (decrease) keys. Press the SAVE/EXIT key to save the new atmospheric (span) pressure value. For example, if your known local uncorrected barometric pressure is 760 Torr, enter 760 in the SET ATM screen. The main pressure measurement screen will now display 760 Torr while the gauge is at atmosphere.

It is good practice to perform the sequence of checking and adjusting span (ATM) then zero (VAC) and then, finally rechecking the span setting to ensure that the circuitry is properly balanced for use in measuring pressure throughout the intended measurement range.

SP1 ON and SP2 ON [Factory default = 100 mTORR]

These setpoints correspond to the pressures at which the relays will turn on (energize). The relays will turn on when the pressure is below the programmed pressure value. If you are unable to increase the values of SP1 ON or SP2 ON, you must first go to SP1 OFF or SP2 OFF and increase those values to a number higher than the values of SP1 ON or SP2 ON you are trying to set.

SET SP1 OFF and SET SP2 OFF [Factory default = 200 mTORR]

These setpoints correspond to the pressures at which the relays will turn off (de-energize). The relays will turn off when the pressure is above the programmed pressure value. If you are unable to decrease the values of SP1 OFF or SP2 OFF, you must first go to SP1 ON or SP2 ON and decrease those values to a number lower than the values of SP1 OFF or SP2 OFF you are trying to set.

RS485 ADDR [Factory default = 1]

This is the lower nibble of the one byte RS485 device address. Assuming the address offset (ADDR OFFSET) is equal to 0, setting the ADDR to a 5 will make the address be 0x05 in hexadecimal. A 15 will set the ADDR to 0x0F in hexadecimal. Note that the address (ADDR) must be used even when sending RS232 commands.

RS485 OFFSET [Factory default = 0]

This is the upper nibble of the one byte RS485 address. Assuming the address (ADDR) is 0, setting the address offset (ADDR OFFSET) to a 5 will make the address be 0x50 hexadecimal. Setting the address offset to 15 will make the device address be 0xF0 hexadecimal.

ADDRESS DECIMAL	BINARY ADDRESS		ADDRESS HEXA- DECIMAL
	ONE BYTE		
	(BINARY)		
	ADDR OFFSET ┌Upper nibble┐	ADDR ┌Lower nibble┐	
1	0 0 0 0	0 0 0 1	01
5	0 0 0 0	0 1 0 1	05
15	0 0 0 0	1 1 1 1	0F
16	0 0 0 1	0 0 0 0	F0

BAUD [Factory default = 19,200]

This sets the baud rate for the RS485 and the RS232 serial communications. The baud rate can be set to various values through the serial interface or via the front panel soft-keys. The parity can only be changed through the serial interface command set. When this occurs, the current setting will be shown in the list of choices and can be re-selected if changed.

RS485 TYPE [Factory default = 2 WIRE]

Selects 2-wire or 4-wire configuration for RS485 interface.

ANALOG TYPE [Factory default = LOG 1-8]

Select one of the following analog output types based on your system requirements (See section 7.0 for details).

- LOG 1-8. This selection provides a 1 to 8 V (dc) log-linear analog output with 1 V/decade.
- LOG 0-7. This selection provides a 0 to 7 V (dc) log-linear analog output with 1 V/decade.
- NONLIN 6V. This selection provides a non-linear (S-Curve) analog output from 0.3751 to 5.6593 V (dc).
- NONLIN 9V. This selection provides a non-linear (S-Curve) analog output from 0 to 9 V (dc).
- LINEAR. This selection provides a 0 to 10 V (dc) linear analog output with a useful range over 3 decades.

SET LINEAR [Factory default = 0.01 VOLTS to 10 VOLTS corresponding to 1 mTORR to 1 TORR]

If you have selected LINEAR in the ANALOG TYPE menu above, then configure the linear analog output scaling using the following parameters in the SET LINEAR menu. (See section 7.9 for more details).

- Set the minimum pressure
- Set the minimum voltage corresponding to the minimum pressure

- c) Set the maximum pressure
- d) Set the maximum voltage corresponding to the maximum pressure

Note - The LINEAR analog output provides a linear 0-10 V (dc) output signal. The linear output voltage can be any value between 10 mV and 10 V corresponding to displayed pressure between 1 mTorr and 1000 Torr. However, the useful range of the linear analog output is three decades. If your application requires the analog output to cover a pressure range exceeding three decades then consider using the non-linear or the log-linear analog output. See ANALOG TYPE menu above to select Log-linear or non-linear analog output.

INFO

This screen shows the unit firmware version.

AOUT CAL

This has been pre-set in the factory and is used to optimize the analog output calibration. It is recommended that the user not make this adjustment unless the displayed pressure on the VGC031 and the resulting pressure calculation from the analog output do not match closely. To perform this adjustment, connect the gauge to the VGC031 and connect the VGC031 analog output to a high resolution voltmeter, your system, PLC, etc. While in the AOUT CAL screen and with the gauge exposed to atmosphere, use the INC or DECR soft-keys to adjust the analog output to match the corresponding pressure displayed on the screen. Example: The VGC031 ANALOG TYPE is set to LOG 1-8. In the AOUT CAL screen, the atmospheric pressure is displayed at 760 Torr. Based on the equation and table given in section 7.1 the expected analog output at 760 Torr is 7.881 V. Use the INC or DECR soft-keys in the AOUT CAL screen to set the analog output to 7.881 V as recorded by your voltmeter, PLC, etc. Alternatively, if the analog output is used to display the pressure in your PLC or your system display console, adjust the AOUT CAL while the gauge is exposed to atmosphere so that the atmospheric pressure displayed by your PLC matches the atmospheric pressure displayed by the VGC031. The AOUT

CAL can be performed at any pressure between 400 Torr to 999 Torr (atmosphere recommended).

SCREEN SAVER [Factory default = ON]

The VGC031 uses an OLED type display which over an extended period of time can start to show divergence between pixels that are on at all times versus pixels that are not. This could result in pixels exhibiting a burned-in effect. To minimize the burned-in effect, a screen saver function can be activated by programming the SCREEN SAVER menu selection to ON. With the screen saver function turned on, the display appearance changes every 12 hours. The display will appear in the normal mode with a dark background color for the first 12 hours and will then switch to a back-lit background color for the next 12 hours. If you like to have the 12 hour period for the normal display mode to start at a specific time of the day, simply access the SCREEN SAVER menu and change setting to OFF and then ON again. This initiates the screen saver function immediately.

Note - To increase longevity of the OLED display, INFICON recommends that the screen saver function remains ON as shipped from the factory.

4.4 Return to Factory Default Settings

You can reset all values to the original factory default settings by simultaneously pressing the upper left and upper right soft-keys. The user will then be prompted to "Set Factory Defaults?" Choose Yes or No.

If you reset all values to original factory default settings, you would need to repeat the initial setup procedure as described in section 4.1 and reprogram the device as described in section 4.3.

5 Using the Gauge with Different Gases

A thermal conductivity gauge senses heat loss which depends on the thermal conductivity of the gas surrounding the sensor. Since different gases, and mixtures, have different thermal conductivities, the indicated pressure readings and outputs will also be different. INFICON convection gauges (and most other thermal conductivity gauges) are calibrated using nitrogen (N_2). When a gas other than N_2 / air is used, correction must be made for the difference in thermal conductivity between nitrogen (N_2) and the gas in use. The charts and tables on the following pages indicate how different gases affect the display and output from an INFICON convection gauge.



WARNING! Using a thermal conductivity gauge with gases other than that for which it is calibrated could result in death or serious injury. Be sure to use gas correction data in this manual when measuring pressures of gases other than N_2 / air.

For N_2 the calibration shows excellent agreement between indicated and true pressure throughout the range from 10^{-4} to 1000 Torr. At pressures below 1 Torr, the calibration curves for the different gases are similar. The difference in readings at these low pressures is a constant, a function of the difference between thermal conductivities of the gases.

At pressures above 1 Torr, indicated pressure readings may diverge significantly. At these higher pressures convection currents in the gauge become the predominant cause of heat loss from the sensor and calibration depends on gauge tube geometry and mounting position as well as gas properties.

Generally, air and N_2 are considered the same with respect to thermal conductivity, but even N_2 and air will exhibit slight differences in readings at higher pressures. For example, when venting a system to atmosphere using N_2 , you may see readings change by 30 to 40 Torr after the chamber is opened and air gradually displaces the N_2 in the gauge. For most other gases the effect is much more significant and may result in a hazardous condition as described below.

Other considerations when using gases other than N₂ / air

Flammable or explosive gases



WARNING! INFICON convection gauges are neither intrinsically safe nor explosion proof and are not intended for use in the presence of flammable or explosive gases or vapors.

Under normal conditions the voltages and currents in INFICON convection gauges are too low to cause ignition of flammable gases. However, under certain failure conditions, sufficient energy could be generated to cause flammable vapors or gases to ignite or explode. Thermal conductivity gauges like the INFICON convection gauges are not recommended for use with flammable or explosive gases.

Moisture / water vapor

In some processes (lyophilization, for example) the gas composition may not change significantly, except for moisture content. Water vapor can significantly change the response of a thermal gauge and correction should be made, as you would for any other gas.

Other contaminants

If your gases condense, coat, or corrode the sensor, the gauge calibration and response to different gases will change. Generally, if the gauge can be "calibrated" ("zero" and "span" settings), these changes are small enough to be ignored. If you can't set zero and span, the gauge should be replaced or return to factory for evaluation and possible cleaning.

Convection Vacuum Gauge Indicated vs. true total pressure (test gases N₂, Ar, He)

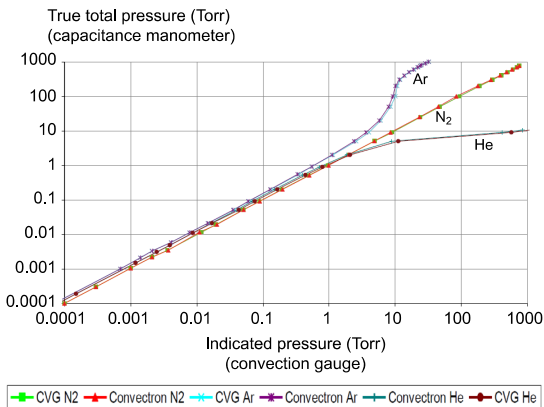

Gas Correction Chart

The Y-axis of the above chart is actual pressure as measured by a capacitance manometer, a diaphragm gauge that measures true total pressure independent of gas composition. The X-axis is the pressure reading indicated by the convection gauge under test. This chart shows readings for an INFICON convection gauge (PGE) and Granville-Phillips® Convector® gauge to illustrate that the difference in the response for both of these types of gauges is virtually indistinguishable.

CAUTION! Do not assume this data applies to other convection gauges which may or may not be the same. Refer to the table on the next page and note the following examples:

Example A: If the gas is nitrogen (N₂), when the true total pressure is 500 Torr, the gauge will read 500 Torr.

Example B: If the gas is argon (Ar), when the true pressure is 100 Torr, the gauge will read about 9 Torr. If you are backfilling your vacuum system with Ar, when your system reaches a pressure of 760 Torr true pressure your gauge will be reading about

23 Torr. Continuing to backfill your system, attempting to increase the reading up to 760 Torr, you will over pressurize your chamber which may present a hazard.

Example C: If the gas is helium (He), the gauge will read over pressure (OP) when pressure reaches about 10 Torr true pressure and opening the chamber to atmosphere prematurely may present other hazards for both people and product.

CAUTION! What these examples illustrate is that using gases other than nitrogen (N_2) without using accurate gas conversion data and other proper precautions could result in injury to personnel and/or damage to equipment.

Suggested precautions when using gases other than nitrogen (N_2):

Install a pressure relief valve or burst disk on your chamber, to protect it from overpressure. Post a warning label on your gauge readout that states "Do Not Exceed ____ Torr Indicated Pressure" (fill in the blank for maximum indicated pressure for the gas you use) so that an operator using the gauge will not exceed a safe pressure.

6 Display

6.1 Display - Torr / mTorr

Displayed pressure readings vs. true pressure for selected gases - engineering units in Torr / mTorr (see following table):

Pressure shown in bold italic font in the shaded areas are in mTorr.

Pressure shown in normal font in non shaded areas are in Torr.

True Total Pressure [Torr / mTorr]	N ₂	Ar	He	O ₂	CO ₂	KR	Freon 12	Freon 22	D ₂	Ne	CH ₄
0 mTorr	0.0	0.0	0.0	0.0	0.0	0.0	0.0	0.0	0.0	0.0	0.0
0.1 mTorr	0.1	0.1	0.1	0.1	0.1	0.1	0.1	0.1	0.1	0.1	0.1
0.2 mTorr	0.2	0.2	0.2	0.2	0.2	0.2	0.2	0.2	0.2	0.2	0.2
0.5 mTorr	0.5	0.5	0.5	0.5	0.5	0.5	0.5	0.5	0.5	0.5	0.5
1 mTorr	1.0	0.7	0.8	1.0	1.1	0.4	1.5	1.5	1.3	0.7	1.7
2 mTorr	2.0	1.4	1.6	2.0	2.3	1.0	3.1	3.1	2.4	1.5	3.3
5 mTorr	5.0	3.3	4.0	5.0	4.4	2.3	7.6	7.0	6.0	3.5	7.7
10 mTorr	10.0	6.6	8.1	9.7	11.0	4.8	14.7	13.5	12.1	7.1	15.3
20 mTorr	20.0	13.1	16.1	19.8	22.2	9.5	29.9	27.2	24.3	14.1	30.4
50 mTorr	50.0	32.4	40.5	49.2	54.9	23.5	72.5	69.0	60.0	34.8	77.2
100 mTorr	100	64.3	82.0	97.2	107	46.8	143	136	121	70.0	159

(continued)

Table "Displayed pressure readings vs. true pressure - units in Torr / mTorr" (continued)

True Total Pressure [Torr / mTorr]	N ₂	Ar	He	O ₂	CO ₂	KR	Freon 12	Freon 22	D ₂	Ne	CH ₄
200 mTorr	200	126	165	194	210	91.1	275	262	250	141	315
500 mTorr	500	312	435	486	489	217	611	594	687	359	781
1 Torr	1.00	600	940	970	950	400	1.05	1.04	1.55	745	1.60
2 Torr	2.00	1.14	2.22	1.94	1.71	700	1.62	1.66	4.13	1.59	3.33
5 Torr	5.00	2.45	13.5	4.98	3.34	1.28	2.45	2.62	246	5.24	7.53
10 Torr	10.0	4.0	OP	10.3	4.97	1.78	2.96	3.39	OP	21.5	27.9
20 Torr	20.0	5.80	OP	22.3	6.59	2.29	3.32	3.72	OP	584	355
50 Torr	50.0	7.85	OP	77.6	8.22	2.57	3.79	4.14	OP	OP	842
100 Torr	100	8.83	OP	209	9.25	2.74	4.68	4.91	OP	OP	OP
200 Torr	200	9.79	OP	295	12.3	3.32	5.99	6.42	OP	OP	OP

(continued)

Table "Displayed pressure readings vs. true pressure - units in Torr / mTorr" (concluded)

True Total Pressure [Torr / mTorr]	N ₂	Ar	He	O ₂	CO ₂	KR	Freon 12	Freon 22	D ₂	Ne	CH ₄
300 Torr	300	11.3	OP	380	16.9	3.59	6.89	7.52	OP	OP	OP
400 Torr	400	13.5	OP	485	22.4	3.94	7.63	8.42	OP	OP	OP
500 Torr	500	16.1	OP	604	28.7	4.21	8.28	9.21	OP	OP	OP
600 Torr	600	18.8	OP	730	36.4	4.44	8.86	9.95	OP	OP	OP
700 Torr	700	21.8	OP	859	46.1	4.65	9.42	10.7	OP	OP	OP
760 Torr	760	23.7	OP	941	53.9	4.75	9.76	11.1	OP	OP	OP
800 Torr	800	25.1	OP	997	59.4	4.84	9.95	11.4	OP	OP	OP
900 Torr	900	28.5	OP	OP	79.5	4.99	10.5	12.0	OP	OP	OP
1000 Torr	1000	32.5	OP	OP	111	5.08	11.1	12.7	OP	OP	OP

Notes:

- 1) OP = overpressure indication: display will read over pressure
- 2) Display auto-ranges between Torr and mTorr at 1 Torr

Examples:

- 1) Gas used is nitrogen (N_2). Display shows pressure measurement of 10 Torr. True pressure of nitrogen is 10 Torr.
- 2) Gas used is argon (Ar). Display shows pressure measurement of 600 mTorr. True pressure of argon is 1 Torr.
- 3) Gas used is oxygen (O_2). Display shows pressure measurement of 486 mTorr. True pressure of oxygen is 500 mTorr.

6.2 Display - mbar

The table below shows the displayed readings at various pressures for selected gases when engineering units selected is in mbar.

Displayed pressure readings vs. true pressure for selected gases - engineering units in mbar (see following table):

True Pressure [mbar]	N ₂	Ar	He	O ₂	CO ₂	KR	Freon 12	Freon 22	D ₂	Ne	CH ₄
0	0.0	0.0	0.0	0.0	0.0	0.0	0.0	0.0	0.0	0.0	0.0
.0001	.0001	.0001	.0001	.0001	.0001	.0001	.0001	.0001	.0001	.0001	.0001
.0003	.0003	.0003	.0003	.0003	.0003	.0003	.0003	.0003	.0003	.0003	.0003
.0006	.0006	.0006	.0006	.0006	.0006	.0004	.0006	.0006	.0006	.0006	.0006
.0013	.0013	.0009	.0011	.0013	.0015	.0005	.0020	.0020	.0017	.0009	.0023
.0027	.0027	.0019	.0021	.0027	.0031	.0013	.0041	.0041	.0032	.0020	.0044
.0067	.0067	.0044	.0053	.0067	.0059	.0031	.0101	.0093	.0080	.0047	.0102
.0133	.0133	.0088	.0107	.0129	.0146	.0064	.0195	.0179	.0161	.0095	.0203
.0206	.0206	.0174	.0214	.0263	.0295	.0126	.0398	.0362	.0323	.0187	.0405
.0666	.0666	.0431	.0539	.0655	.0731	.0313	.0966	.0919	.0799	.0463	.0100
0.130	0.130	.0857	0.110	0.120	0.140	0.0623	0.190	0.180	0.160	0.100	0.210

(continued)

Table "Displayed pressure readings vs. true pressure - units in mbar" (continued)

True Pressure [mbar]	N ₂	Ar	He	O ₂	CO ₂	KR	Freon 12	Freon 22	D ₂	Ne	CH ₄
0.260	0.260	0.160	0.210	0.250	0.270	0.120	0.360	0.340	0.330	0.180	0.410
0.666	0.666	0.410	0.570	0.640	0.650	0.280	0.810	0.790	0.910	0.470	1.04
1.33	1.33	0.790	1.25	1.29	1.26	0.530	1.39	1.38	2.06	0.990	2.13
2.66	2.66	1.51	2.95	2.58	2.27	0.930	2.15	2.21	5.50	2.11	4.43
6.66	6.66	3.26	17.9	6.63	4.45	1.70	3.26	3.49	327	6.98	10.0
13.3	13.3	5.33	OP	13.7	6.62	2.37	3.94	4.51	OP	28.6	37.1
26.6	26.6	7.73	OP	29.7	8.78	3.05	4.42	4.95	OP	778	473
66.6	66.6	10.4	OP	103	10.9	3.42	5.05	5.51	OP	OP	1012
133	133	11.7	OP	278	12.3	3.65	6.23	6.54	OP	OP	OP
266	266	13.0	OP	393	16.3	4.42	7.98	8.55	OP	OP	OP

(continued)

Table "Displayed pressure readings vs. true pressure - units in mbar" (concluded)

True Pressure [mbar]	N ₂	Ar	He	O ₂	CO ₂	KR	Freon 12	Freon 22	D ₂	Ne	CH ₄
400	400	15.0	OP	506	22.5	4.78	9.18	10.0	OP	OP	OP
533	533	17.9	OP	646	29.8	5.25	10.1	11.2	OP	OP	OP
666	666	21.4	OP	805	38.2	5.61	11.0	12.2	OP	OP	OP
800	800	25.0	OP	973	48.5	5.91	11.8	13.2	OP	OP	OP
933	933	29.0	OP	1140	61.4	6.19	12.5	14.2	OP	OP	OP
1011	1011	31.5	OP	1250	71.8	6.33	13.0	14.7	OP	OP	OP
1060	1060	33.4	OP	1320	79.1	6.45	13.2	15.1	OP	OP	OP
1190	1190	37.9	OP	OP	105	6.65	13.9	16.0	OP	OP	OP
1330	1330	43.3	OP	OP	147	6.77	14.7	16.9	OP	OP	OP

Values listed under each gas type are in mbar.

Notes:

- 1) OP = Overpressure indication; display will read "overpressure".

Examples:

- 1) Gas used is nitrogen. Display shows pressure measurement of 13.3 mbar. True pressure of nitrogen is 13.3 mbar.
- 2) Gas used is argon. Display shows pressure measurement of 11.7 mbar. True pressure of argon is 133 mbar.
- 3) Gas used is CO₂. Display shows pressure measurement of .0731 mbar. True pressure of CO₂ is .0666 mbar.

7 Analog Output

The VGC031 provides either a non-linear, log-linear or a 0-10 V (dc) linear analog output signal. These analog output signals are also compatible with various Granville-Phillips® Mini-Convectron® modules as well as Convectron® gauge controller series 375, 475 and the original 1/4 DN 275 Analog Convectron Gauge Controllers. Please read this section in its entirety to determine which one of the five analog output types to select from.

LOG 1-8; Log-Linear Analog Output

The LOG 1-8 setting selected from the ANALOG TYPE menu produces a log-linear analog output signal of 1 to 8 V (dc) for 1.0E-4 to 1000 Torr of N₂. This output, shown below, is a 1 Volt per decade signal that may be easier to use for data logging / control than the non-linear analog output.

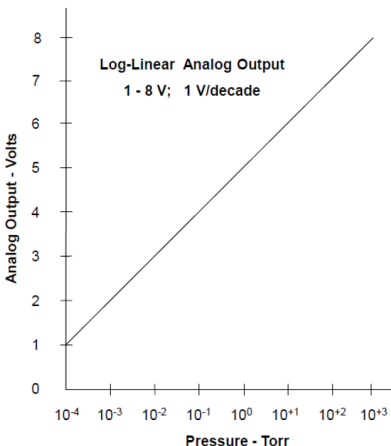

Selecting the LOG 1-8 setting from the INFICON VGC031 ANALOG TYPE menu duplicates the analog outputs of the Granville-Phillips Convectron[®] gauge controller series 375 and 475.

The equations and tables shown in section 7.1 and section 7.2 contain the lookup data for converting the LOG 1-8 output voltage into pressure values for nitrogen and various other gases.

LOG 0-7; Log-Linear Analog Output

The LOG 0-7 setting selected from the ANALOG TYPE menu produces a log-linear analog output signal of 0 to 7 V (dc) for $1.0E-4$ to 1000 Torr of N_2 . This output, shown below, is a 1 Volt per decade signal that may be easier to use for data logging / control than the non-linear output.

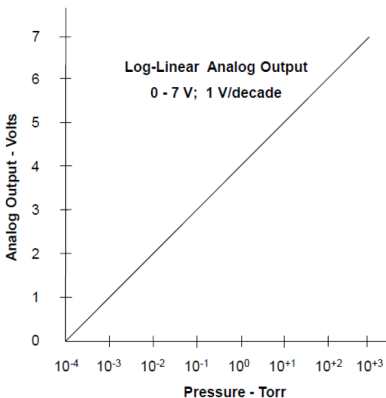

Selecting the LOG 0-7 setting from the INFICON VGC031 ANALOG TYPE menu duplicates the analog outputs of the Granville-Phillips Convectron[®] gauge controller series 375 and 475.

The equations and tables shown in section 7.3 and section 7.4 contain the lookup data for converting the LOG 0-7 output voltage into pressure values for nitrogen and various other gases.

NONLIN 6V; Non-Linear Analog Output, S-Curve

The NONLIN 6V setting selected from the ANALOG TYPE menu produces a non-linear analog output signal of 0.375 to 5.659 V (dc) for 0 to 1000 Torr of N₂, roughly in the shape of an "S" curve, as shown below.

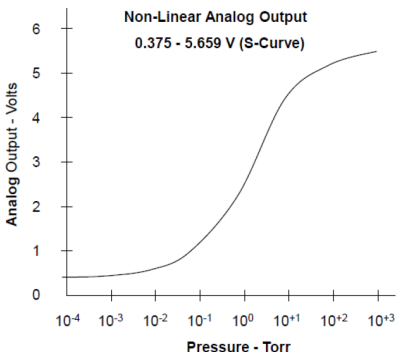

Selecting the NONLIN 6V setting from the INFICON VGC031 ANALOG TYPE menu duplicates the Granville-Phillips Mini-Convectron® modules original S-curve of 0.375 to 5.659 V (dc) corresponding to 0 to 1000 Torr.

The equations shown in section 7.5 and tables shown in section 7.6 and section 7.7 contain the lookup data for converting the NONLIN 6V output voltage into pressure values for nitrogen and various other gases.

NONLIN 9V; Non-Linear Analog Output, S-Curve

The NONLIN 9V setting selected from the ANALOG TYPE menu produces a non-linear analog output signal of 0 to 9 V (dc) for 0 to 1000 Torr of N₂, roughly in the shape of an "S" curve, as shown below.

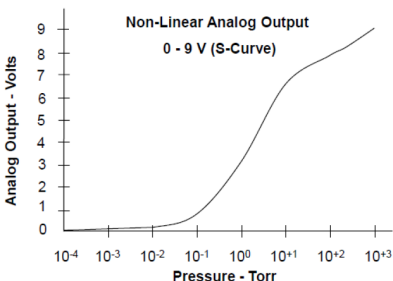

Selecting the NONLIN 9V setting from the INFICON VGC031 ANALOG TYPE menu duplicates the analog outputs (S-Curve) of the Granville-Phillips Convectron® gauge controller series 375, 475 and the original 1/4 DN 275 Analog Convectron Gauge Controllers.

The equations and table shown in section 7.8 contain the lookup data for converting the NONLIN 9V output voltage into pressure values for nitrogen and various other gases.

LINEAR; 0-10 V (dc) Linear Analog Output

The VGC031 also provides a linear 0-10 V (dc) analog output. The linear output voltage can be any value between 0.01 V and 10 V corresponding to displayed pressure between 1 mTorr and 1000 Torr. However, the useful range of the linear analog output is three decades. For example if the minimum pressure selected is 1 mTorr (1.00×10^{-3} Torr) with a corresponding minimum voltage output of 0.01 volts, then maximum pressure selected to correspond to a maximum voltage output of 10 volts should not exceed 1.00 Torr. If your application requires the analog output to cover a pressure range exceeding three decades then consider using the log-linear or non-linear analog output. See section 7.9 for more detailed explanation.

7.1 Log 1-8; Log-Linear Analog Output Equation & Table - Torr

Log-Linear 1 to 8 V analog output for selected gases - Engineering units in Torr (see following table):

True Pressure [Torr]	N ₂	Ar	He	O ₂	CO ₂	KR	Freon 12	Freon 22	D ₂	Ne	CH ₄
0.0001	1.000	1.000	1.000	1.000	1.000	1.000	1.000	1.000	1.000	1.000	1.000
0.0002	1.3011	1.301	1.301	1.301	1.301	1.301	1.301	1.301	1.301	1.301	1.301
0.0005	1.699	1.699	1.699	1.699	1.699	1.477	1.699	1.699	1.699	1.699	1.699
0.0010	2.000	1.845	1.903	2.000	2.041	1.602	2.176	2.176	2.114	1.845	2.230
0.0020	2.301	2.146	2.204	2.301	2.362	2.000	2.491	2.491	2.380	2.176	2.519
0.0050	2.699	2.519	2.602	2.699	2.643	2.362	2.881	2.845	2.778	2.544	2.886
0.0100	3.000	2.820	2.908	2.987	3.041	2.681	3.167	3.130	3.083	2.851	3.185
0.0200	3.301	3.117	3.207	3.297	3.346	2.978	3.476	3.435	3.386	3.149	3.483
0.0500	3.699	3.511	3.607	3.692	3.740	3.371	3.860	3.839	3.778	3.542	3.888
0.1000	4.000	3.808	3.914	3.988	4.029	3.670	4.155	4.134	4.083	3.845	4.201
0.2000	4.301	4.100	4.217	4.288	4.322	3.960	4.439	4.418	4.398	4.149	4.498

(continued)

Table "Log-Linear 1 to 8 V analog output - Torr" (continued)

True Pressure [Torr]	N ₂	Ar	He	O ₂	CO ₂	KR	Freon 12	Freon 22	D ₂	Ne	CH ₄
0.5000	4.699	4.494	4.638	4.687	4.689	4.336	4.786	4.774	4.837	4.555	4.893
1.0000	5.000	4.778	4.973	4.987	4.978	4.602	5.021	5.017	5.190	4.872	5.204
2.0000	5.301	5.057	5.346	5.288	5.233	4.845	5.210	5.220	5.616	5.201	5.522
5.0000	5.699	5.389	6.130	5.697	5.524	5.107	5.389	5.418	7.391	5.719	5.877
10.0000	6.000	5.602	8.041	6.013	5.696	5.250	5.471	5.530	8.041	6.332	6.446
20.0000	6.301	5.763	8.041	6.348	5.819	5.360	5.521	5.571	8.041	7.766	7.550
50.0000	6.699	5.895	8.041	6.890	5.915	5.410	5.579	5.617	8.041	8.041	7.925
100.0000	7.000	5.946	8.041	7.320	5.966	5.438	5.670	5.691	8.041	8.041	8.041
200.0000	7.301	5.991	8.041	7.470	6.090	5.521	5.777	5.808	8.041	8.041	8.041
300.0000	7.477	6.053	8.041	7.580	6.228	5.555	5.838	5.876	8.041	8.041	8.041

(continued)

Table "Log-Linear 1 to 8 V analog output - Torr" (concluded)

True Pressure [Torr]	N ₂	Ar	He	O ₂	CO ₂	KR	Freon 12	Freon 22	D ₂	Ne	CH ₄
400.0000	7.602	6.130	8.041	7.686	6.350	5.595	5.883	5.925	8.041	8.041	8.041
500.0000	7.699	6.207	8.041	7.781	6.458	5.624	5.918	5.964	8.041	8.041	8.041
600.0000	7.778	6.274	8.041	7.863	6.561	5.647	5.947	5.998	8.041	8.041	8.041
700.0000	7.845	6.338	8.041	7.934	6.664	5.667	5.974	6.029	8.041	8.041	8.041
760.0000	7.881	6.375	8.041	7.974	6.732	5.677	5.989	6.045	8.041	8.041	8.041
800.0000	7.903	6.400	8.041	7.999	6.774	5.685	5.998	6.057	8.041	8.041	8.041
900.0000	7.954	6.455	8.041	8.041	6.900	5.698	6.021	6.079	8.041	8.041	8.041
1000.0000	8.000	6.512	8.041	8.041	7.045	5.706	6.045	6.104	8.041	8.041	8.041

Values listed under each gas type are in volts.

The log-linear output signal and pressure in the table above are related by the following formulas:

$$P = 10^{(V - 5)}$$

$$V = \log_{10}(P) + 5$$

where P is the pressure in Torr, and V is the output signal in volts.

An analog output of 10 volts indicates a faulty convection gauge or unplugged gauge cable.

The chart on the following page shows the graphical results of the table and formulas given above for nitrogen.

True pressure (N_2) is plotted on the X-axis with a log scale. The output signal is plotted on the Y-axis on a linear scale.

Note - when using the units of pascals and LOG 1-8 is selected, the same equation of $P = 10^{(V-5)}$ listed above applies. This results in a log-linear analog output range of about 3.00 V (dc) at .01 pascals (Pa) and 10.12 V (dc) at 133 kPa.

LOG 1-8; Log-Linear Analog Output Voltage vs. Pressure [Torr]

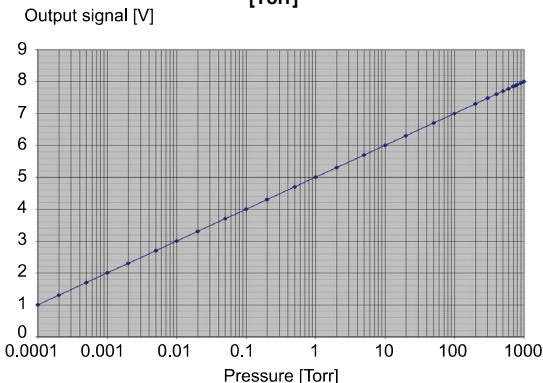

Chart of the calculated pressures using the formulas and data for the log-linear output signal for nitrogen from the previous page.

7.2 Log 1-8; Log-Linear Analog Output Equation & Table - mbar

Log-Linear 1 to 8 V analog output for selected gases - Engineering units in mbar (see following table):

True Pressure [mbar]	N ₂	Ar	He	O ₂	CO ₂	KR	Freon 12	Freon 22	D ₂	Ne	CH ₄
0.0001	1.000	1.000	1.000	1.000	1.000	1.000	1.000	1.000	1.000	1.000	1.000
0.0002	1.301	1.301	1.301	1.301	1.301	1.301	1.301	1.301	1.301	1.301	1.301
0.0005	1.699	1.699	1.699	1.699	1.523	1.699	1.699	1.699	1.699	1.699	1.699
0.0010	2.000	1.903	1.938	2.000	2.028	1.668	2.125	2.125	2.080	1.903	2.167
0.0020	2.301	2.146	2.204	2.301	2.355	1.970	2.487	2.487	2.392	2.166	2.523
0.0050	2.699	2.524	2.602	2.699	2.672	2.370	2.883	2.855	2.778	2.551	2.893
0.0100	3.000	2.820	2.908	2.991	3.012	2.675	3.172	3.136	3.082	2.849	3.186
0.0200	3.301	3.188	3.208	3.294	3.345	2.979	3.473	3.434	3.385	3.150	3.484
0.0500	3.699	3.512	3.607	3.693	3.741	3.372	3.863	3.837	3.779	3.543	3.886
0.1000	4.000	3.809	3.928	3.989	4.033	3.671	4.157	4.136	4.082	3.844	4.197
0.2000	4.301	4.103	4.217	4.288	4.325	3.963	4.445	4.424	4.393	4.148	4.500

(continued)

Table "Log-Linear 1 to 8 V analog output - units in mbar" (continued)

True Pressure [mbar]	N ₂	Ar	He	O ₂	CO ₂	KR	Freon 12	Freon 22	D ₂	Ne	CH ₄
0.5000	4.699	4.495	4.634	4.686	4.696	4.341	4.798	4.783	4.825	4.553	4.893
1.0000	5.000	4.784	4.962	4.987	4.982	4.614	5.044	5.037	5.174	4.867	5.201
2.0000	5.301	5.064	5.324	5.288	5.249	4.865	5.250	5.255	5.579	5.192	5.517
5.0000	5.699	5.404	6.070	5.695	5.550	5.141	5.447	5.471	7.288	5.696	5.877
10.0000	6.000	5.633	8.125	6.008	5.743	5.309	5.556	5.602	8.125	6.252	6.374
20.0000	6.301	5.815	8.125	6.337	5.886	5.433	5.621	5.675	8.125	7.608	7.409
50.0000	6.699	5.969	8.125	6.862	6.002	5.514	5.680	5.722	8.125	8.125	8.125
100.0000	7.000	6.045	8.125	7.282	6.065	5.548	5.751	5.780	8.125	8.125	8.125
200.0000	7.301	6.903	8.125	7.526	6.157	5.606	5.851	5.877	8.125	8.125	8.125
300.0000	7.477	6.131	8.125	7.625	6.253	5.654	5.918	5.950	8.125	8.125	8.125

(continued)

Table "Log-Linear 1 to 8 v analog output - units in mbar" (continued)

True Pressure [mbar]	N ₂	Ar	He	O ₂	CO ₂	KR	Freon 12	Freon 22	D ₂	Ne	CH ₄
400.0000	7.602	6.178	8.125	7.705	6.353	5.679	5.962	6.000	8.125	8.125	8.125
500.0000	7.699	6.237	8.125	7.786	6.448	5.710	5.996	6.038	8.125	8.125	8.125
600.0000	7.778	6.295	8.125	7.861	6.532	5.734	6.025	6.070	8.125	8.125	8.125
700.0000	7.845	6.349	8.125	7.928	6.611	5.754	6.050	6.097	8.125	8.125	8.125
760.0000	7.881	6.380	8.125	7.965	6.658	5.765	6.063	6.112	8.125	8.125	8.125
800.0000	7.903	6.399	8.125	7.988	6.687	5.772	6.072	6.122	8.125	8.125	8.125
900.0000	7.954	6.488	8.125	8.042	6.766	5.787	6.092	6.146	8.125	8.125	8.125
1000.0000	8.000	6.494	8.125	8.092	6.847	5.799	6.111	6.167	8.125	8.125	8.125
1100.0000	8.041	6.539	8.125	8.125	6.936	5.812	6.128	6.187	8.125	8.125	8.125
1200.0000	8.079	6.580	8.125	8.125	7.028	5.822	6.146	6.204	8.125	8.125	8.125

(continued)

Table "Log-Linear 1 to 8 V analog output - units in mbar" (concluded)

True Pressure [mbar]	N ₂	Ar	He	O ₂	CO ₂	KR	Freon 12	Freon 22	D ₂	Ne	CH ₄
1300.0000	8.114	6.624	8.125	8.125	7.140	5.828	6.164	6.222	8.125	8.125	8.125
1333.0000	8.125	6.636	8.125	8.125	7.169	5.830	6.169	6.228	8.125	8.125	8.125

Values listed under each gas type are in volts.

The log-linear output signal and pressure in the table above are related by the following formulas:

$$P = 10^{(V - 5)} \quad V = \log_{10}(P) + 5$$

where P is the pressure in mbar, and V is the output signal in volts.

An analog output of 10 volts indicates a faulty convection gauge or unplugged gauge cable.

The chart on the following page shows the graphical results of the table and formulas given above for nitrogen. True pressure (N₂) is plotted on the X-axis with a log scale. The output signal is plotted on the Y-axis on a linear scale.

Note - when using the units of pascals and LOG 1-8 is selected, the same equation of $P = 10^{(V-5)}$ listed above applies. This results in a log-linear analog output range of about 3.00 V (dc) at .01 pascals (Pa) and 10.12 V (dc) at 133 kPa.

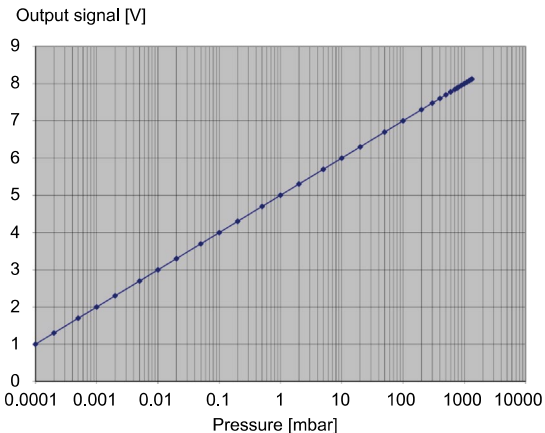

Chart of the calculated pressures using the formulas and data for the log-linear output signal for nitrogen from the previous page.

7.3 Log 0-7; Log-Linear Analog Output Equation & Table - Torr

Log-Linear 0 to 7 V analog output for selected gases - Engineering units in Torr (see following table):

True Pressure [Torr]	N ₂	Ar	He	O ₂	CO ₂	KR	Freon 12	Freon 22	D ₂	Ne	CH ₄
0.0001	0.000	0.000	0.000	0.000	0.000	0.000	0.000	0.000	0.000	0.000	0.000
0.0002	0.3011	0.301	0.301	0.301	0.301	0.301	0.301	0.301	0.301	0.301	0.301
0.0005	0.699	0.699	0.699	0.699	0.699	0.477	0.699	0.699	0.699	0.699	0.699
0.0010	1.000	0.845	0.903	2.000	1.041	0.602	1.176	1.176	1.114	0.845	1.230
0.0020	1.301	1.146	1.204	1.301	1.362	1.000	1.491	1.491	1.380	1.176	1.519
0.0050	1.699	1.519	1.602	1.699	1.643	1.362	1.881	1.845	1.778	1.544	1.886
0.0100	2.000	1.820	1.908	1.987	2.041	1.681	2.167	2.130	2.083	1.851	2.185
0.0200	2.301	2.117	2.207	2.297	2.346	1.978	2.476	2.435	2.386	2.149	2.483
0.0500	2.699	2.511	2.607	2.692	2.740	2.371	2.860	2.839	2.778	2.542	2.888
0.1000	3.000	2.808	2.914	2.988	3.029	2.670	3.155	3.134	3.083	2.845	3.201
0.2000	3.301	3.100	3.217	3.288	3.322	2.960	3.439	3.418	3.398	3.149	3.498

(continued)

Table "Log-Linear 0 to 7 V analog output - Torr" (continued)

True Pressure [Torr]	N ₂	Ar	He	O ₂	CO ₂	KR	Freon 12	Freon 22	D ₂	Ne	CH ₄
0.5000	3.699	3.494	3.638	3.687	3.689	3.336	3.786	3.774	3.837	3.555	3.893
1.0000	4.000	3.778	3.973	3.987	3.978	3.602	4.021	4.017	4.190	3.872	4.204
2.0000	4.301	4.057	4.346	4.288	4.233	3.845	4.210	4.220	4.616	4.201	4.522
5.0000	4.699	4.389	5.130	4.697	4.524	4.107	4.389	4.418	6.391	4.719	4.877
10.0000	5.000	4.602	7.041	5.013	4.696	4.250	4.471	4.530	7.041	5.332	5.446
20.0000	5.301	4.763	7.041	5.348	4.819	4.360	4.521	4.571	7.041	6.766	6.550
50.0000	5.699	4.895	7.041	5.890	4.915	4.410	4.579	4.617	7.041	7.041	6.925
100.0000	6.000	4.946	7.041	6.320	4.966	4.438	4.670	4.691	7.041	7.041	7.041
200.0000	6.301	4.991	7.041	6.470	5.090	4.521	4.777	4.808	7.041	7.041	7.041
300.0000	6.477	5.053	7.041	6.580	5.228	4.555	4.838	4.876	7.041	7.041	7.041

(continued)

Table "Log-Linear 0 to 7 V analog output - Torr" (concluded)

True Pressure [Torr]	N ₂	Ar	He	O ₂	CO ₂	KR	Freon 12	Freon 22	D ₂	Ne	CH ₄
400.0000	6.602	5.130	7.041	6.686	5.350	4.595	4.883	4.925	7.041	7.041	7.041
500.0000	6.699	5.207	7.041	6.781	5.458	4.624	4.918	4.964	7.041	7.041	7.041
600.0000	6.778	5.274	7.041	6.863	5.561	4.647	4.947	4.998	7.041	7.041	7.041
700.0000	6.845	5.338	7.041	6.934	5.664	4.667	4.974	5.029	7.041	7.041	7.041
760.0000	6.881	5.375	7.041	6.974	5.732	4.677	4.989	5.045	7.041	7.041	7.041
800.0000	6.903	5.400	7.041	6.999	5.774	4.685	4.998	5.057	7.041	7.041	7.041
900.0000	6.954	5.455	7.041	7.041	5.900	4.698	5.021	5.079	7.041	7.041	7.041
1000.0000	7.000	5.512	7.041	7.041	6.045	4.706	5.045	5.104	7.041	7.041	7.041

Values listed under each gas type are in volts.

The log-linear output signal and pressure in the table above are related by the following formulas:

$$P = 10^{(V - 4)}$$

$$V = \log_{10}(P) + 4$$

where P is the pressure in Torr, and V is the output signal in volts.

An analog output of 10 volts indicates a faulty convection gauge or unplugged gauge cable.

The chart on the following page shows the graphical results of the table and formulas given above for nitrogen. True pressure (N_2) is plotted on the X-axis with a log scale. The output signal is plotted on the Y-axis on a linear scale.

Note - when using the units of pascals and LOG 0-7 is selected, the same equation of $P = 10^{(V-4)}$ listed above applies. This results in a log-linear analog output range of about 2.00 V (dc) at .01 pascals (Pa) and 9.12 V (dc) at 133 kPa.

LOG 0-7; Log-Linear Analog Output Voltage vs. Pressure [Torr]

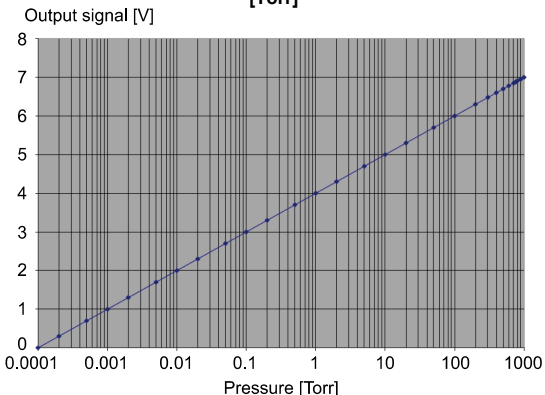

Chart of the calculated pressures using the formulas and data for the log-linear output signal for nitrogen from the previous page.

7.4 Log 0-7; Log-Linear Analog Output Equation & Table - mbar

Log-Linear 0 to 7 V analog output for selected gases - Engineering units in mbar (see following table):

True Pressure [mbar]	N ₂	Ar	He	O ₂	CO ₂	KR	Freon 12	Freon 22	D ₂	Ne	CH ₄
0.0001	0.000	0.000	0.000	0.000	1.000	0.000	0.000	0.000	0.000	0.000	0.000
0.0002	0.301	0.301	0.301	0.301	0.301	0.301	0.301	0.301	0.301	0.301	0.301
0.0005	0.699	0.699	0.699	0.699	0.523	0.699	0.699	0.699	0.699	0.699	0.699
0.0010	1.000	0.903	0.938	1.000	1.028	0.668	1.125	1.125	1.080	0.903	1.167
0.0020	1.301	1.146	1.204	1.301	1.355	0.970	1.487	1.487	1.392	1.166	1.523
0.0050	1.699	1.524	1.602	1.699	1.672	1.370	1.883	1.855	1.778	1.551	1.893
0.0100	2.000	1.820	1.908	1.991	2.012	1.675	2.172	2.136	2.082	1.849	2.186
0.0200	2.301	2.188	2.208	2.294	2.345	1.979	2.473	2.434	2.385	2.150	2.484
0.0500	2.699	2.512	2.607	2.693	2.741	2.372	2.863	2.837	2.779	2.543	2.886
0.1000	3.000	2.809	2.928	2.989	3.033	2.671	3.157	3.136	3.082	2.844	3.197
0.2000	3.301	3.103	3.217	3.288	3.325	2.963	3.445	3.424	3.393	3.148	3.500

(continued)

Table "Log-Linear 0 to 7 V analog output - units in mbar" (continued)

True Pressure [mbar]	N ₂	Ar	He	O ₂	CO ₂	KR	Freon 12	Freon 22	D ₂	Ne	CH ₄
0.5000	3.699	3.495	3.634	3.686	3.696	3.341	3.798	3.783	3.825	3.553	3.893
1.0000	4.000	3.784	3.962	3.987	3.982	3.614	4.044	4.037	4.174	3.867	4.201
2.0000	4.301	4.064	4.324	4.288	4.249	3.865	4.250	4.255	4.579	4.192	4.517
5.0000	4.699	4.404	5.070	4.695	4.550	4.141	4.447	4.471	6.288	4.696	4.877
10.0000	5.000	4.633	7.125	5.008	4.743	4.309	4.556	4.602	7.125	5.252	5.374
20.0000	5.301	4.815	7.125	5.337	4.886	4.433	4.621	4.675	7.125	6.608	6.409
50.0000	5.699	4.969	7.125	5.862	5.002	4.514	4.680	4.722	7.125	7.125	7.125
100.0000	6.000	5.045	7.125	6.282	5.065	4.548	4.751	4.780	7.125	7.125	7.125
200.0000	6.301	5.903	7.125	6.526	5.157	4.606	4.851	4.877	7.125	7.125	7.125
300.0000	6.477	5.131	7.125	6.625	5.253	4.654	4.918	4.950	7.125	7.125	7.125

(continued)

Table "Log-Linear 0 to 7 v analog output - units in mbar" (continued)

True Pressure [mbar]	N ₂	Ar	He	O ₂	CO ₂	KR	Freon 12	Freon 22	D ₂	Ne	CH ₄
400.0000	6.602	5.178	7.125	6.705	5.353	4.679	4.962	5.000	7.125	7.125	7.125
500.0000	6.699	5.237	7.125	6.786	5.448	4.710	4.996	5.038	7.125	7.125	7.125
600.0000	6.778	5.295	7.125	6.861	5.532	4.734	5.025	5.070	7.125	7.125	7.125
700.0000	6.845	5.349	7.125	6.928	5.611	4.754	5.050	5.097	7.125	7.125	7.125
760.0000	6.881	5.380	7.125	6.965	5.658	4.765	5.063	5.112	7.125	7.125	7.125
800.0000	6.903	5.399	7.125	6.988	5.687	4.772	5.072	5.122	7.125	7.125	7.125
900.0000	6.954	5.488	7.125	7.042	5.766	4.787	5.092	5.146	7.125	7.125	7.125
1000.0000	7.000	5.494	7.125	7.092	5.847	4.799	5.111	5.167	7.125	7.125	7.125
1100.0000	7.041	5.539	7.125	7.125	5.936	4.812	5.128	5.187	7.125	7.125	7.125
1200.0000	7.079	5.580	7.125	7.125	6.028	4.822	5.146	5.204	7.125	7.125	7.125

(continued)

Table "Log-Linear 0 to 7 V analog output - units in mbar" (concluded)

True Pressure [mbar]	N ₂	Ar	He	O ₂	CO ₂	KR	Freon 12	Freon 22	D ₂	Ne	CH ₄
1300.0000	7.114	5.624	7.125	7.125	6.140	4.828	5.164	5.222	7.125	7.125	7.125
1333.0000	7.125	5.636	7.125	7.125	6.169	4.830	5.169	5.228	7.125	7.125	7.125

Values listed under each gas type are in volts.

The log-linear output signal and pressure in the table above are related by the following formulas:

$$P = 10^{(V - 4)}$$

$$V = \log_{10}(P) + 4$$

where P is the pressure in mbar, and V is the output signal in volts.

An analog output of 10 volts indicates a faulty convection gauge or unplugged gauge cable.

The chart on the following page shows the graphical results of the table and formulas given above for nitrogen. True pressure (N₂) is plotted on the X-axis with a log scale. The output is plotted on the Y-axis on a linear scale.

Note - when using the units of pascals and LOG 0-7 is selected, the same equation of $P = 10^{(V-4)}$ listed above applies. This results in a log-linear analog output range of about 2.00 V (dc) at .01 pascals (Pa) and 9.12 V (dc) at 133 kPa.

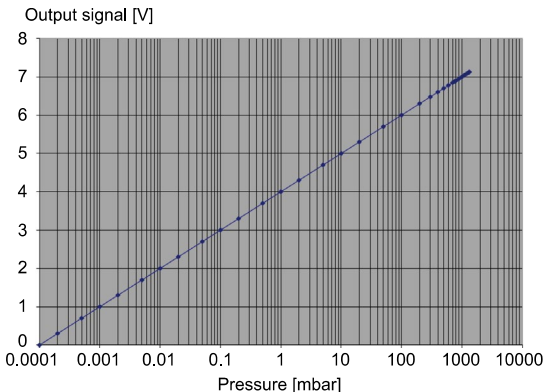

Chart of the calculated pressures using the formulas and data for the log-linear output signal for nitrogen from the previous page.

7.5 NONLIN 6V; Non-Linear Analog Output Equations

You may calculate the N2/air pressure represented by the **0.375 to 5.659 V** non-linear analog output voltage for the "S-curve" using a multi-segment, n^{th} order polynomial function calculation. The coefficients for the n^{th} order polynomial equation defined for various pressure measurement ranges are given in the following table:

For Non-Linear Analog Output voltage range of **0.375 to 2.842 volts**, use this table.

Coefficients for $y(x) = a + bx + cx^2 + dx^3 + ex^4 + fx^5$	
a	-0.02585
b	0.03767
c	0.04563
d	0.1151
e	-0.04158
f	0.008738

For Non-Linear Analog Output voltage range of **2.842 to 4.945 volts**, use this table.

Coefficients for $y(x) = \frac{a+cx+ex^2}{1+bx+dx^2+fx^3}$	
a	0.1031
b	-0.3986
c	-0.02322
d	0.07438
e	0.07229
f	-0.006866

For Non-Linear Analog Output voltage range of **4.94 to 5.659 volts**, use this table.

Coefficients for $y(x) = \frac{a+cx}{1+bx+dx^2}$	
a	100.624
b	-0.37679
c	-20.5623
d	0.0348656

Where $y(x)$ = pressure in Torr,
 x = measured analog output in volts

Example: Measured analog output voltage is 0.3840 V.

From first table shown above use equation:

$$y(x) = a + bx + cx^2 + dx^3 + ex^4 + fx^5$$

$x = 0.3840$ volts

$a = -0.02585$, $b = 0.03767$, $c = 0.04563$, $d = 0.1151$,

$e = -0.04158$, $f = 0.008738$

$y(x) = \text{Pressure} = 1.0\text{E-}03$ Torr

The equations listed above are used to calculate the non-linear voltage outputs for N_2/air shown in tables of section 7.6 and section 7.7 below. Non-linear voltage outputs for various other gases are also shown in the same tables.

7.6 NONLIN 6V; Non-Linear Analog Output Table - Torr

Non-Linear 0.375 to 5.659 V analog output for selected gases - Engineering units in Torr/mTorr (see following table):

True Total Pressure [Torr / mTorr]	N ₂	Ar	He	O ₂	CO ₂	KR	Freon 12	Freon 22	D ₂	Ne	CH ₄
0 mTorr	0.3751	0.3750	0.3750	0.3750	0.3750	0.3750	0.3750	0.3750	0.3750	0.3750	0.3750
0.1 mTorr	0.3759	0.3757	0.3755	0.3760	0.3760	0.3755	0.3760	0.3760	0.3760	0.3757	0.3766
0.2 mTorr	0.3768	0.3760	0.3765	0.3770	0.3770	0.3768	0.3780	0.3780	0.3770	0.3763	0.3780
0.5 mTorr	0.3795	0.3780	0.3790	0.3800	0.3810	0.3772	0.3820	0.3810	0.3810	0.3782	0.3825
1 mTorr	0.3840	0.3810	0.3820	0.3840	0.3850	0.3790	0.3880	0.3880	0.3860	0.3810	0.3896
2 mTorr	0.3927	0.3870	0.3890	0.3920	0.3950	0.3840	0.4010	0.4000	0.3960	0.3880	0.4030
5 mTorr	0.4174	0.4030	0.4090	0.4170	0.4120	0.3950	0.4370	0.4320	0.4250	0.4050	0.4380
10 mTorr	0.4555	0.4290	0.4410	0.4530	0.4620	0.4150	0.4880	0.4800	0.4700	0.4330	0.4920
20 mTorr	0.5226	0.4770	0.4970	0.5210	0.5360	0.4510	0.5810	0.5660	0.5490	0.4840	0.5840
50 mTorr	0.6819	0.5950	0.6370	0.6790	0.7050	0.5440	0.7780	0.7640	0.7270	0.6080	0.7960
100 mTorr	0.8780	0.7450	0.8140	0.8680	0.9000	0.6680	1.0090	0.9900	0.9440	0.7680	1.0530

(continued)

Table "Non-Linear 0.375 to 5.659 V analog output - units in Torr / mTorr" (continued)

True Total Pressure [Torr / mTorr]	N ₂	Ar	He	O ₂	CO ₂	KR	Freon 12	Freon 22	D ₂	Ne	CH ₄
200 mTorr	1.1552	0.9620	1.0680	1.1410	1.1790	0.8470	1.3150	1.2910	1.2650	1.0020	1.3920
500 mTorr	1.6833	1.3860	1.5890	1.6640	1.6680	1.1940	1.8260	1.8050	1.9140	1.4690	2.0140
1 Torr	2.2168	1.8180	2.1640	2.1950	2.1720	1.5360	2.2570	2.2470	2.6030	1.9760	2.6320
2 Torr	2.8418	2.3330	2.9390	2.8140	2.6950	1.9210	2.6470	2.6660	3.5080	2.6310	3.3130
5 Torr	3.6753	3.0280	4.3870	3.6720	3.3160	2.4290	3.0290	3.0900	5.0590	3.7150	
10 Torr	4.2056	3.4800	5.7000	4.2250	3.6700	2.7340	3.2040	3.3300	5.700	4.6050	4.6990
20 Torr	4.5766	3.8010	5.700	4.6200	3.9030	2.9660	3.3080	3.4140	5.700	5.4060	5.1720
50 Torr	4.8464	4.0370	5.700	4.9160	4.0710	3.0750	3.4300	3.5090	5.700	6.1590	5.5830
100 Torr	4.9449	4.1220	5.700	5.0260	4.1540	3.1340	3.6180	3.6600	5.700	6.4830	5.7200
200 Torr	5.0190	4.1920	5.700	5.1060	4.3360	3.2690	3.8270	3.8830	5.700	6.6610	5.8600

(continued)

Table "Non-Linear 0.375 to 5.659 V analog output - units in Torr / mTorr" (concluded)

True Total Pressure [Torr / mTorr]	N ₂	Ar	He	O ₂	CO ₂	KR	Freon 12	Freon 22	D ₂	Ne	CH ₄
300 Torr	5.1111	4.2830	5.700	5.2000	4.5020	3.3840	3.9380	4.0050	5.700	6.7260	
400 Torr	5.2236	4.3860	5.700	5.3150	4.6210	3.4660	4.0160	4.0880	5.700	6.7670	6.1030
500 Torr	5.3294	4.4770	5.700	5.4220	4.7080	3.5260	4.0760	4.1510	5.700	6.8030	
600 Torr	5.4194	4.5500	5.700	5.5150	4.7750	3.5730	4.1240	4.2030	5.700	6.8430	6.3420
700 Torr	5.4949	4.6110	5.700	5.5920	4.8300	3.6130	4.1660	4.2470	5.700	6.8900	
760 Torr	5.5340	4.6430	5.700	5.6330	4.8600	3.6320	4.1900	4.2710	5.700	6.9200	
800 Torr	5.5581	4.6630	5.700	5.6580	4.8770	3.6450	4.2030	4.2860	5.700	6.9420	6.5190
900 Torr	5.6141	4.7060	5.700	5.7130	4.9190	3.6740	4.2370	4.3210	5.700	7.0000	
1000 Torr	5.6593	4.7450	5.700	5.7620	4.9550	3.6900	4.2700	4.3540	5.700	7.0560	6.6420

Values listed under each gas type are in volts.

Note: By design, these values are identical to the outputs from MKS Instruments / Granville-Phillips® Convector® gauges, Mini-Convector® modules and controllers so that equivalent units can be interchanged without affecting your process system or software.

An analog output of 10 volts indicates a faulty convection gauge or unplugged gauge cable.

7.7 NONLIN 6V; Non-Linear Analog Output Table - mbar

Non-Linear 0.375 to 5.659 V analog output for selected gases - Engineering units in mbar (see following table):

True Pressure [mbar]	N ₂	Ar	He	O ₂	CO ₂	KR	Freon 12	Freon 22	D ₂	Ne	CH ₄
0	0.3751	0.375	0.375	0.375	0.375	0.375	0.375	0.375	0.375	0.375	0.375
.0001	0.3759	0.3757	0.376	0.376	0.376	0.376	0.376	0.376	0.376	0.376	0.376
.0003	0.3768	0.376	0.377	0.377	0.377	0.377	0.378	0.378	0.377	0.3763	0.378
.0006	0.3795	0.378	0.379	0.38	0.381	0.381	0.382	0.381	0.381	0.3782	0.3825
.0013	0.384	0.381	0.382	0.384	0.385	0.379	0.388	0.388	0.386	0.381	0.3896
.0027	0.3927	0.387	0.389	0.392	0.395	0.384	0.401	0.4	0.396	0.388	0.403
.0067	0.4174	0.403	0.409	0.417	0.412	0.395	0.437	0.432	0.425	0.405	0.438
.0133	0.4555	0.429	0.441	0.453	0.462	0.415	0.488	0.48	0.47	0.433	0.492
.0266	0.5226	0.477	0.497	0.521	0.536	0.451	0.581	0.566	0.549	0.484	0.584
.0660	0.6819	0.595	0.637	0.679	0.705	0.544	0.778	0.764	0.727	0.608	0.796
0.13	0.878	0.745	0.814	0.868	0.9	0.668	1.009	0.99	0.944	0.768	1.053

(continued)

Table "Non-Linear 0.375 to 5.659 V analog output - units in mbar" (continued)

True Pressure [mbar]	N ₂	Ar	He	O ₂	CO ₂	KR	Freon 12	Freon 22	D ₂	Ne	CH ₄
0.26	1.1552	0.962	1.068	1.141	1.179	0.847	1.315	1.291	1.265	1.002	1.392
0.66	1.6833	1.386	1.589	1.664	1.668	1.194	1.826	1.805	1.914	1.4689	2.014
1.33	2.2168	1.818	2.164	2.195	2.172	1.536	2.257	2.247	2.603	1.976	2.632
2.66	2.8418	2.333	2.939	2.814	2.695	1.921	2.647	2.666	3.508	2.631	3.313
6.66	3.6753	3.028	4.387	3.672	3.316	2.429	3.029	3.09	5.059	3.715	
13.3	4.2056	3.48	5.700	4.225	3.67	2.735	3.204	3.33	5.700	4.605	4.699
26.6	4.5766	3.801	5.700	4.62	3.903	2.966	3.308	3.414	5.700	5.406	5.172
66.6	4.8464	4.037	5.700	4.916	4.071	3.075	3.43	3.509	5.700	6.159	5.583
133	4.9449	4.122	5.700	5.026	4.154	3.134	3.618	3.66	5.700	6.483	5.72
266	5.019	4.192	5.700	5.106	4.336	3.269	3.827	3.883	5.700	6.661	5.86

(continued)

Table "Non-Linear 0.375 to 5.659 V analog output - units in mbar" (concluded)

True Pressure [mbar]	N ₂	Ar	He	O ₂	CO ₂	KR	Freon 12	Freon 22	D ₂	Ne	CH ₄
400	5.1111	4.283	5.700	5.2	4.502	3.384	3.938	4.005	5.700	6.726	
533	5.2236	4.386	5.700	5.315	4.621	3.466	4.016	4.088	5.700	6.767	6.103
666	5.3294	4.477	5.700	5.422	4.708	3.526	4.076	4.151	5.700	6.803	
800	5.4194	4.55	5.700	5.515	4.775	3.573	4.124	4.203	5.700	6.843	6.342
933	5.4949	4.611	5.700	5.592	4.83	3.613	4.166	4.247	5.700	6.89	
1010	5.534	4.643	5.700	5.633	4.86	3.632	4.19	4.271	5.700	6.92	
1060	5.5581	4.663	5.700	5.658	4.877	3.645	4.203	4.286	5.700	6.942	6.519
1190	5.6141	4.706	5.700	5.713	4.919	3.674	4.237	4.321	5.700	7	
1330	5.6593	4.745	5.700	5.762	4.955	3.69	4.270	4.354	5.700	7.056	6.642

Values listed under each gas type are in volts.

Note: By design, these values are identical to the outputs from MKS Instruments / Granville-Phillips® Convector® gauges, Mini-Convector® modules and controllers so that equivalent units can be interchanged without affecting your process system or software.

An analog output of 10 volts indicates a faulty convection gauge or unplugged gauge cable.

7.8 NONLIN 9V; Non-Linear Analog Output Equations & Table

You may calculate the N₂/air pressure represented by the NONLIN 9V, 0 to 9 V non-linear analog output voltage for the "S-curve" using a multi-segment, nth order polynomial function calculation. Use the coefficients listed in the table below to calculate pressure using the following equation:

$$P = K_0 + K_1(454.67*V_1) + K_2(454.67*V_1)^2 + K_3(454.67*V_1)^3$$

Where P=Pressure in Torr, V1=Analog output voltage

Coefficients for voltage segment range of 0 to 1.8457 volts	
K ₀	K ₀ = +0.000000E+00
K ₁	K ₁ = +1.428571E-04
K ₂	K ₂ = +2.551020E-07
K ₃	K ₃ = +9.110787E-11

Coefficients for voltage segment range of 1.8457 to 3.1641 volts	
K ₀	K ₀ = -2.681040E-01
K ₁	K ₁ = +9.758000E-04
K ₂	K ₂ = -5.950000E-07
K ₃	K ₃ = +3.750000E-10

Coefficients for voltage segment range of 3.1641 to 4.3945 volts	
K_0	$K_0 = +1.100000E+00$
K_1	$K_1 = -1.675000E-03$
K_2	$K_2 = +1.125000E-06$
K_3	$K_3 = +7.414069E-21$

Coefficients for voltage segment range of 4.3945 to 6.54785 volts	
K_0	$K_0 = -3.777930E+01$
K_1	$K_1 = +5.495931E-02$
K_2	$K_2 = -2.652588E-05$
K_3	$K_3 = +4.526774E-09$

Coefficients for voltage segment range of 6.54785 to 7.3828 volts	
K_0	$K_0 = -7.184400E+03$
K_1	$K_1 = +7.117083E+00$
K_2	$K_2 = -2.354167E-03$
K_3	$K_3 = +2.604167E-07$

Coefficients for voltage segment range of 7.3828 to 7.6465 volts	
K_0	$K_0 = -5.439800E+04$
K_1	$K_1 = +4.990375E+01$
K_2	$K_2 = -1.528125E-02$
K_3	$K_3 = +1.562500E-06$

Coefficients for voltage segment range of 7.6465 to 7.9102 volts	
K_0	$K_0 = +1.811462E+06$
K_1	$K_1 = -1.511014E+03$
K_2	$K_2 = +4.196562E-01$
K_3	$K_3 = -3.880208E-05$

Coefficients for voltage segment range of 7.9102 to 9 volts	
K_0	$K_0 = -2.417225E+05$
K_1	$K_1 = +1.919958E+02$
K_2	$K_2 = -5.106048E-02$
K_3	$K_3 = +4.554342E-06$

Example: Measured analog output voltage is: $V_1 = 5.6243$ V.
 Since analog output in this example is 5.6243 V, use the Coefficients from the fourth table shown in the previous page:

$$K_0 = -3.777930E+01, \quad K_1 = +5.495931E-02, \\ K_2 = -2.652588E-05, \quad K_3 = +4.526774E-09$$

Use equation from the previous page;

$$P = K_0 + K_1(454.67 \cdot V_1) + K_2(454.67 \cdot V_1)^2 + K_3(454.67 \cdot V_1)^3$$

$$P = \text{Pressure} = 5.00 \text{ Torr}$$

The following pressure vs. voltage table is derived from equations and coefficients listed above.

NONLIN 9V, Non-Linear Output Voltage vs. Pressure in Torr units for N2 /Air

Pressure [Torr]	Voltage [V (dc)]	Pressure [Torr]	Voltage [V (dc)]	Pressure [Torr]	Voltage [V (dc)]
0.0000	0.0000	2.0E-01	1.3310	4.0E+02	8.2587
1.0E-04	0.0016	5.0E-01	2.2289	5.0E+02	8.4375
2.0E-04	0.0031	1.0E+00	3.1352	6.0E+02	8.5915
5.0E-04	0.0077	2.0E+00	4.1968	7.0E+02	8.7196
1.0E-03	0.0153	5.0E+00	5.6243	7.6E+02	8.7862
2.0E-03	0.0302	1.0E+01	6.5245	8.0E+02	8.8271
5.0E-03	0.0727	2.0E+01	7.1531	9.0E+02	8.9193
1.0E-02	0.1385	5.0E+01	7.6145	1.0E+03	9.0000
2.0E-02	0.2536	1.0E+02	7.7804		
5.0E-02	0.5260	2.0E+02	7.9102		
1.0E-01	0.8583	3.0E+02	8.0743		

An analog output of 10 volts indicates a faulty convection gauge or unplugged gauge cable.

7.9 LINEAR ANALOG OUTPUT

The VGC031 analog output may be setup to provide a 0-10 V (dc) output signal that has a direct linear relationship to the displayed pressure. When preparing to setup and process the linear analog output signal, first define the following parameters that you will program into the VGC031:

- Minimum measured pressure (for the defined analog output range)
- Minimum output voltage desired (proportional to the minimum pressure)

- Maximum measured pressure (for the analog output signal range)
- Maximum output voltage desired (proportional to maximum pressure)

Constructing a table of these parameters may be useful in documenting the relationship of displayed pressure to the analog output voltage. For example, the following table is representative of a typical setup where;

Min P = 1.00E-03 Torr Min Voltage = 0.01 Volts

Max P = 1.00 Torr Max Voltage = 10 V

Linear Analog Output Voltage - volts	Measured (Displayed) Pressure - torr
0.01	1.00E-03
0.10	1.00E-02
1.00	1.00E-01
10.00	1.00E+00

It is recommended that the Linear output signal be setup such that the range covers, at most, 3 decades of pressure change. For example, if the minimum pressure selected is 1 mtorr (1.00E-03 torr) with a corresponding minimum voltage output of 0.01 volts, then the maximum pressure selected to correspond to a maximum voltage of 10.0 volts should not exceed 1.00 torr.

Doing this is considered best practice when using this type of analog output signal with the VGC031.

If your application requires the analog output voltage to cover a pressure range exceeding three decades, then consider using the log-linear or non-linear analog output.

Note - When using the LINEAR (0-10 V (dc)) analog output, an output of 11 volts indicates a faulty convection gauge or unplugged gauge cable.

8 RS485 / RS232 serial communications

8.1 Device Specific Serial Communication Info

The standard VGC031 model provides RS232 / RS485 serial communications. The following information and the RS485 / RS232 command protocol summary listed on the next page should be used to set serial communications with the device.

- 1) Default settings are 19200 baud rate, 8 data bits, No Parity, 1 stop bit [Factory default; 19200, 8, N, 1].
- 2) The baud rate can be set to different values through the serial interface command set or the front panel push buttons.
- 3) The parity can be changed only through the serial interface command set and the number of data bits will change according to the parity selected.
- 4) The stop bit is always 1.
- 5) All Responses are 13 characters long.
- 6) xx is the address of the device (00 thru FF).
- 7) <CR> is a carriage return.
- 8) _ is a space.
- 9) The 'z' in the set or read trip point commands is a + or -. The plus is the 'turns on below' point and the minus is the 'turns off above' point.
- 10) All commands sent to the module start with a '#' character, and all responses from the module start with a '*' character.
- 11) This protocol was designed to be 100% compatible with the Granville-Phillips® Mini-Convectron®.
- 12) A valid address must be used even in RS232 commands [Factory default = 1].

8.2 RS485 / RS232 Command Protocol Summary

COMMAND	BRIEF DESCRIPTION	COMMAND SYNTAX	RESPONSE
READ	Read the current pressure in Torr	#xxRD<CR> (eg: #01RD<CR>)	*xx.y.yyEzzy<CR> (eg: *01_7.60E+02<CR>)
SET ADDR OFFSET & ADDRESS	Set the communications (RS485) address offset (upper nibble) and Address (1)	#xxSAxx<CR> (eg: #01SA20<CR>) In example #01SA20 above ; 2=ADDR OFFSET, 0= ADDRESS	*xx_PROGM_OK<CR>
SET SPAN	Set the span or atmosphere calibration point	#xxTSy.yyEzzy<CR> (eg: #01TS7.60E+02)	*xx_PROGM_OK<CR>
SET ZERO	Set the zero or vacuum calibration point	#xxTZy.yyEzzy<CR> (eg: #01TZ0.00E-04<CR>)	*xx_PROGM_OK<CR>
SET TRIP POINT #1	Set the 'turns on below' pressure point for relay #1 and set the 'turns off above' pressure point for relay #1. (2)	#xxSLz.yyEzzy<CR> (eg: #01SL+4.00E+02<CR>) (eg: #01SL-5.00E+02<CR>)	*xx_PROGM_OK<CR>
SET TRIP POINT #2	Set the 'turns on below' pressure point for relay #2 and set the 'turns off above' pressure point for relay #2. (2)	#xxSHz.yyEzzy<CR> (eg: #01SH+4.00E+02<CR>) (eg: #01SH-5.00E+02<CR>)	*xx_PROGM_OK<CR>
READ TRIP POINT #1	Read the 'turns on below' pressure point for relay #1 and read the 'turns off above' pressure point for relay #1.	#xxRLz<CR> (eg: #01RL+<CR>) (eg: #01RL-<CR>)	*xx.y.yyEzzy<CR> (eg: *01_7.60E+02<CR>)

(continued)

Table "RS485 / RS232 command protocol summary" (continued)

COMMAND	BRIEF DESCRIPTION	COMMAND SYNTAX	RESPONSE
READ TRIP POINT #2	Read the 'turns on below' pressure point for relay #2 and read the 'turns off above' pressure point for relay #2.	#xxRHZ<CR> (eg: #01RH+<CR>) (eg: #01RH-<CR>)	*xx_yyEzzy<CR> (eg: *01_7.60E+02<CR>)
READ SW VERSION	Read the revision number of the firmware.	#xxVER<CR> (eg: #01VER<CR>)	*xx_mmmnv-vv (eg: *0105041-00)
SET FACTORY DEFAULTS	Force unit to return ALL settings back to the way the factory programmed them before shipment. (1)	#xxFAC<CR> (eg: #01FAC<CR>)	*xx_PROGM_OK<CR>
SET BAUD RATE	Set the communications baud rate for RS485 and RS232. (1)	#xxSByyyy<CR> (eg: #01SB19200<CR>)	*xx_PROGM_OK<CR>
SET NO PARITY	Set the communications to NO parity, 8 bits for the RS485 and RS232. (1)	#xxSPN<CR> (eg: #01SPN<CR>)	*xx_PROGM_OK<CR>
SET ODD PARITY	Set the communications to ODD parity, 7 bits for the RS485 and RS232. (1)	#xxSPO<CR> (eg: #01SPO<CR>)	*xx_PROGM_OK<CR>

(continued)

Table "RS485 / RS232 command protocol summary" (concluded)

COMMAND	BRIEF DESCRIPTION	COMMAND SYNTAX	RESPONSE
SET EVEN PARITY	Set the communications to EVEN parity, 7 bits for the RS485/ RS232. (1)	#xxSPE<CR> (eg: #01SPE<CR>)	*xx_PROGM_OK<CR>
RESET	Reset the device. (required to complete some of the commands.)	#xxRST<CR> (eg: #01RST<CR>)	No response

- (1) Commands marked with a (1) under the "BRIEF DESCRIPTION" column will not take effect until after RESET command is sent or power is cycled. This protocol was designed to be 100% compatible with the Granville-Phillips® Mini-Convectron®.
- (2) Commands marked with a (2) under the "BRIEF DESCRIPTION" column will not take effect until after ADDR OFFSET & ADDRESS command is resent followed by the RESET command.

9 Service

9.1 Calibration

Every INFICON PGE050 sensor is calibrated prior to shipment using nitrogen (N_2). However, you can calibrate the instrument by adjusting zero (vacuum) and span (atmosphere) using the procedure described previously in section 4.3 titled "Programming". Zero and span (atmosphere) calibration affect the displayed value and the output signal. Zero calibration optimizes performance of the gauge when operating at a low pressure range of 1.00×10^{-4} Torr to 1.00×10^{-3} Torr. If your minimum operating pressure is higher than 1.00×10^{-3} Torr, it is not normally necessary to perform calibration at zero and thus span calibration should be adequate. If you are able to evacuate your system to below 1.00×10^{-4} Torr, it is always a good practice to check and set zero if necessary. This will also improve performance in cases where gauge contamination is causing higher readings than 1.00×10^{-4} Torr even though the system has been evacuated to below 1.00×10^{-4} Torr. Care should be exercised when using gases other than nitrogen (N_2).

9.2 Maintenance

In general, maintenance is not required for your INFICON sensor and controller. Periodic performance checks may be done by comparing the sensor to a known reference standard.

9.3 Troubleshooting

Indication	Possible Cause	Possible Solution
Display is off / blank	No power	Check power supply & power cable
Readings appear very different from expected pressure	The process gas is different from the gas used to calibrate the PGE050 gauge	Correct readings for different gas thermal conductivity. See section 5 on using the gauge with different gases
	PGE050 gauge has not been calibrated or has been calibrated incorrectly	Check that zero and span are adjusted correctly
Readings are noisy or erratic	Loose cables or connections	Check and tighten connections
	Contamination	Inspect the PGE050 for signs of contamination such as particles, deposits, discoloration on gauge inlet. Return to factory for possible cleaning
	Vibration	Ensure gauge is not mounted where excessive vibration is present
Gauge cannot be calibrated - zero and span can't be adjusted	Contamination	Return the PGE050 to factory for possible cleaning
	Sensor failure for other cause	Replace the PGE050
(continued)		

Table "Troubleshooting" (concluded)

Indication	Possible Cause	Possible Solution
Setpoint does not actuate	Incorrect setup	Check setpoint setup
Display shows "Sensor Bad"	Sensor wire damaged	Replace the PGE050
Display shows "overpressure"	System pressure over 1000 Torr	Reduce pressure
	Faulty electronics	Repair or replace the VGC031 electronics
Atmospheric pressure reads too high and can't be set to correct value	Contamination	Return the PGE050 to factory for possible cleaning
	Sensor wire damaged	Replace the PGE050
Atmospheric pressure reads too low and can't be set to correct value	Sensor wire damaged	Replace the PGE050
	Contamination	Return the PGE050 to factory for possible cleaning

10 Factory Service and Support

If you need help setting up, operating, troubleshooting, or obtaining a return materials authorization number (RMA number) to return the module for diagnosis, please contact us during normal business hours (8:00 am to 5:00 pm Mountain time) Monday through Friday, at +423 / 388 3111. Or e-mail us at reachus@inficon.com.

11 Storage



Caution



Electronic component

Inappropriate storage (static electricity, humidity etc.) can damage electronic components.

Store the product in a bag or container. Observe the corresponding specifications in the technical data.

12 Disposal



WARNING



Substances detrimental to the environment

Products or parts thereof (mechanical and electric components, operating fluids etc.) can be detrimental to the environment.

Dispose of such substances in accordance with the relevant local regulations.

Separating the components

After disassembling the product, separate its components according to the following criteria:

- Electronic and non-electronic components
Such components must be separated according to their materials and recycled.

EU Declaration of Conformity



We, INFICON, hereby declare that the equipment mentioned below complies with the provisions the Directive relating to electromagnetic compatibility 2014/30/EU and the Directive on the restriction of the use of certain hazardous substances in electrical and electronic equipment 2011/65/EU.

Vacuum Gauge Controller

VGC031

Standards

Harmonized and international / national standards and specifications:

- EN 61000-6-2:2005 (EMC: generic immunity standard)
- EN 61000-6-4:2007 + A1:2011 (EMC: generic emission standard)
- EN 61010-1:2010 (Safety requirements for electrical equipment for measurement, control and laboratory use)
- EN 61326-1:2013; Group 1, Class A (EMC requirements for electrical equipment for measurement, control and laboratory use)

Manufacturer / Signatures

INFICON AG, Alte Landstraße 6, LI-9496 Balzers

19 July 2016

19 July 2016



Dr. Bernhard Andraeus
Director Product Evolution

Marco Kern
Product Manager

Notes

Original: English



tinb25e1-a



LI-9496 Balzers
Liechtenstein
Tel +423 / 388 3111
Fax +423 / 388 3700
reachus@inficon.com

www.inficon.com