



Operating Manual

FLUE-Mate

Combustion Analyzer

English

1.0	IMPORTANT INFORMATION	06
1.1	Information about this manual	06
1.2	Danger levels and other symbols	06
2.0	SAFETY	07
2.2	Safety check	07
2.2	Intended purpose	07
2.3	Improper use of the product	07
2.4	Precautions for the usage of the Li-Ion battery package	07
3.0	WORKING PRINCIPLE	08
3.1	General overview of the analyzer	08
4.0	DESCRIPTION OF THE PRODUCT	09
4.1	Working principle	09
4.2	Measurement cells	09
4.3	Fuel types	09
4.4	Sample treatment	09
4.5	Pressure sensor, piezoelectric, temperature compensated	09
4.6	Suction pump	09
4.7	Draft measurement with sensor automatic autozero	09
4.8	Bluetooth® connection	10
5.0	COMPONENTS DESCRIPTION	11
5.1	Instrument interface	11
6.0	TECHNICAL SPECIFICATIONS	13
6.1	Technical specifications	13
6.2	Measurement and Accuracy Ranges	14
7.0	USING THE FLUE GAS ANALYZER	15
7.1	Preliminary operations	15
7.2	Warning	15
7.3	Analyzer Power supply	15
	7.3.1 Internal battery charge level	15
	7.3.2 Use with external power pack	16
7.4	QR code generation	16
7.5	Connection diagram	17
8.0	FLUE GAS ANALYSIS	18
8.1	Flue gas Analysis	18
	8.1.1 Switching on the instrument and out-calibration	18
	8.1.2 Preliminary Operations	19
	8.1.3 Inserting the probe inside the stack	19
	8.1.4 Performing the combustion analysis - manual mode	20
	8.1.5 Performing the combustion analysis - auto mode	21
	8.1.6 End of the Analysis	23

9.0	MENU	25
9.1	Menu	25
10.0	MEASUREMENTS	26
10.1	Menu→Sample type	26
10.2	Menu→Sample type→Comb. analysis	27
10.3	Menu→Sample type→Draft	28
10.4	Menu→Sample type→CO air	29
10.5	Menu→Sample type→Pressure	30
11.0	RECALL	31
11.1	Menu→Recall	31
12.0	SETUP	34
12.1	Menu→Setup	34
12.2	Menu→Setup→Analysis	35
12.2.1	Menu→Setup→Analysis→Fuel	36
12.2.2	Menu→Setup→Analysis→Condensation	37
12.2.3	Menu→Setup→Analysis→O2 Reference	38
12.2.4	Menu→Setup→Analysis→Measure units	39
12.2.5	Menu→Setup→Analysis→Autozero	40
12.2.6	Menu→Setup→Analysis→Air temp	41
12.2.7	Menu→Setup→Analysis→CO protection	42
12.3	Menu→Setup→Instrument	44
12.3.1	Menu→Setup→Instrument→Display	45
12.3.2	Menu→Setup→Instrument→Clock	46
12.3.3	Menu→Setup→Instrument→Bluetooth	47
12.4	Menu→Configuration→Alarm	48
12.5	Menu→Configuration→Print	49
12.5.1	Menu→Configuration→Print→Pairing	50
12.6	Menu→Configuration→Language	51
12.7	Menu→Configuration→Reset	52
13.0	SERVICE	53
13.1	Menu→Service	53
13.1.1	Menu→Diagnostic→Sensors	54
13.1.2	Menu→Diagnostic→Gas probe	55
13.1.3	Menu→Diagnostic→Hardware	56
14.0	HELP	57
15.0	SENSORS	58
15.1	Sensors→Sensors arrangement	58
15.2	Sensors→Sensor types and relevant positioning	58
15.3	Sensors→Gas sensors life	58
15.4	Sensors→Gas sensors life table	58

16.0 MAINTENANCE	59
16.1 Maintenance→Routine maintenance	59
16.2 Maintenance→Preventive maintenance	59
17.0 FIRMWARE UPDATE	60
18.0 TROUBLESHOOTING	61
18.1 Troubleshooting→Troubleshooting guide	61
19.0 SPARE PARTS AND SERVICING	63
19.1 Spare parts and servicing→Spare parts	63
19.2 Spare parts and servicing→Accessories	63
19.3 Spare parts and servicing→Service Centers	63
ANNEX A - Data management with “FLUE-Mate” APP	64
ANNEX B - Optional Measurements list / Measurement units matching → abbreviations	66
ANNEX C - Coefficients of the fuels and Formulas	68
WARRANTY	69

Disposing of the device

The device can either be disposed of by the operator or be sent to the manufacturer. The device consists of materials that can be recycled. This option should be exercised to prevent waste and also to protect the environment. During disposal, observe the environmental and safety regulations of your country.

Device cannot be scrapped with the normal domestic waste.

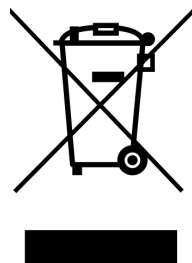

INFICON Inc. - ALL RIGHTS RESERVED -

Total or partial reproduction of this document by any means (including photocopying or storage on any electronic medium) and transmittal of same to third parties in any manner, even electronically, is strictly prohibited unless explicitly authorized in writing by INFICON Inc.

1.1 Information about this manual

- This manual describes the operation and the characteristics and the maintenance of the Combustion Analyzer model FLUE-Mate 502-202-G1 / 502-203-G1.
- Read this operation and maintenance manual before using the device. The operator must be familiar with the manual and follow the instructions carefully.
- This operating manual is *subject to change due to technical improvements - the manufacturer assumes no responsibility for any mistakes or misprints.*

1.2 Danger levels and other symbols



The magnets in the back of the instrument can damage credit cards, hard drives, mechanical watches, pacemakers, defibrillators and other devices proven sensitive to magnetic fields. It is recommended to keep the instrument at a distance of at least 10 inches away from these devices.

Symbol	Meaning	Comments
--------	---------	----------



WARNING

Read information carefully and prepare safety appropriate action!

To prevent any danger from personnel or other goods. Violating the information in this manual may cause danger to personnel, the plant or the environment and may lead to liability loss.



Information on LCD



Keyboard with main control functions.

2.1 Safety check

- Use the product according to what is described in chapter “Intended purpose”.
- During the instrument operation, comply with the current standards.
- Do not use the instrument if damaged on the outer cover, on the power supply plug or on the cables.
- Do not take measures on non-isolated components / voltage conductors.
- Keep the instrument away from solvents.
- For maintenance of the instrument, refer to the “Maintenance” chapter.
- All the interventions not specified in this manual, may be performed exclusively by INFICON service centers. Otherwise, INFICON declines every responsibility about the normal operation of the instrument and on the validity of the several homologations.

2.2 Intended purpose

This chapter describes the areas of application for which FLUE-Mate is intended.

Using the unit in other application areas is on the risk of the operator and the manufacturer assumes no responsibility and liability for loss, damage or costs which could be a result. It is mandatory to read and pay attention to the operating/maintenance manual.

All products of the series 502-202-G1 / 502-203-G1 are handheld measuring devices in professional flue gas analysis for:

- Small residential furnaces (burning oil, gas, wood, coal)
- Low-temperature and condensing boilers
- Gas heaters

2.3 Improper use of the product

FLUE-Mate should not be used:

- As safety alarm instrument
- In classified zones with explosion risk (ATEX or equivalent)

2.4 Precautions for the usage of the Li-Ion battery package

Pay attention while handling the battery package inside the instrument; a wrong or improper usage may lead to heavy physical injuries and/or damages:

- Do not create a short circuit: make sure that the terminals are not in contact with metal or other conductive materials during transportation or storage.
- Do not apply with inverted polarities.
- Do not make the batteries come in contact with liquid substances.
- Do not burn the batteries nor expose to temperature higher than 140 °F (60°C).
- Do not try to disassemble the battery.
- Do not provoke collisions or pierce the batteries. Improper use can cause damages and internal short circuits not always externally visible. If the battery package has fallen or has been hit with an hard surface, regardless the external shell condition:
 - Stop operation;
 - Dispose of the battery in compliance with the disposal instructions.
- Do not use batteries with leaks or damages.
- Charge the batteries only inside the instrument.
- If a malfunction occurs or if over heating signs occur, immediately remove the battery package from the instrument. Warning: the battery may be hot.

3.1 General overview of the analyzer

FLUE-Mate is a portable industrial analyzer for flue gas and emissions monitoring.

The instrument is equipped with:

- Pneumatic line able to manage up to 2 sensors.
- Simple and easy-to-use interface.
- Wide and bright graphic display, White / Black (128x128 mm).
- Rechargeable 'Li-Ion' battery.
- Wall battery charger with output 5V $\overline{=}$, 2A to charge the internal batteries.
When needed, it is possible to recharge the instrument battery using a power bank, as long as it is equipped with 5 volts output and 1A minimum current.

Main functions:

- Combustion analysis in manual and auto mode.
- Includes the 13 most used fuel parameters (such as natural gas, LPG, gas oil and fuel oil).
- Generation of a QR code for easy viewing, saving, and sharing of analysis data on the FLUE-Mate mobile app, available on the App Store® or on Google Play™.

Measured values:

- O₂
- CO
- NO
- Flue stack temperature
- Pressure measurement
- Pressure measurement of the gas line
- CO environment measurement (via the internal sensor)
- Draft measurement

Calculated values:

- Combustion efficiency
- Losses
- CO₂
- NO_x
- Excess air

Maintenance:

- O₂ sensors can be replaced by the user without having to ship the instrument to the service center because the spare sensors delivered are pre-calibrated.
- The instrument requires annual calibration.

Certificate of calibration

The instrument is accompanied with a calibration certificate, according to the ISO/EN 17025 standard.

4.0 DESCRIPTION OF THE PRODUCT

4.1 Working principle

The gas sample is taken in through the gas probe by a diaphragm suction pump inside the instrument. The measuring probe has a sliding cone that allows the probe to be inserted in holes with a diameter of 11 mm to 16 mm and to adjust the immersion depth: **it is recommended to have a gas sampling point roughly in the center of the flue/stack.**

The gas sample is cleaned of humidity and impurities by a condensate trap before reaching the instrument. The gas is then analyzed in its components by electrochemical sensors.

These sensors guarantee high precision results for up to about 60 minutes, during which the instrument can be considered very stable.

If the instrument is used for more than ten consecutive measurements, we suggest restarting the instrument to collect a new ambient air sample and flush the inside of the pneumatic circuit with clean air.

During the zero calibrating phase, the instrument aspirates clean air from the environment and detects the sensor drifts from zero (20.95% for the O₂ sensor), then compares them with the programmed values and compensates them.

4.2 Measurement cells

The instrument uses pre-calibrated gas sensors for the measurement of Oxygen (O₂), Carbon Monoxide (CO) and Nitric Oxide (NO).

The sensors do not need particular maintenance yet they have to be replaced periodically when exhausted.

If sensors of toxic gases are exposed to concentrations higher than 50% of their measurement range for more than 10 minutes continuously, they can show up to ±2% drift as well as a longer time to return to zero.

In this case, before turning off the analyzer, it is advisable to wait for the measured value be lower than 20ppm by running in clean air.

The instrument will also purge or clean the pneumatic circuit. The duration of this purge can be adjusted in the menu Configuration→Analysis→Autozero.

Exhausted sensors can be easily replaced by the user without complicated calibration procedures with certified mixtures as they are pre-calibrated*.

INFICON certifies the accuracy of the measurements only upon a calibration certificate issued by its laboratory or other approved laboratory.

4.3 Fuel types

The device is provided with the technical data of the most common types of fuels stored in its memory.

For more details [see Annex C.](#)

4.4 Sample treatment

The gas sample to be analyzed must be delivered to the measuring sensors properly dried and cleaned of solid residues of combustion; actually for this reason it is usually named 'dry analysis'.

For this purpose, on the gas suction line, is mounted an anti-condensation trap with dust filter.

4.5 Pressure sensor, piezoelectric, temperature compensated

The instrument is internally provided with a piezoresistive differential pressure sensor which can be used for measuring the draft (vacuum) in the stack for differential pressure measurement and possibly for other measurements (pressure of gas in the piping, pressure loss across a filter, etc.).

The measurement range is -10.000 Pa .. +20.000 Pa.

Any potential drift of the sensor are nulled thanks to the autozeroing system.



WARNING
ANY PRESSURE APPLIED TO THE SENSOR GREATER THAN ±300 hPa MAY CAUSE A PERMANENT DEFORMATION OF THE MEMBRANE, THUS DAMAGING IRREVERSIBLY THE SENSOR ITSELF.

4.6 Suction pump

This diaphragm pump, located inside the instrument, is operated with a DC engine powered by the instrument in order to obtain the optimal suction flow rate of the flue gas for the ongoing analysis.

4.7 Draft measurement with sensor automatic autozero

502-202-G1 / 502-203-G1 performs the draft measurement.

The sensor Autozero allows to make the zeroing of the sensor and must be done with the gas probe NOT inserted in the stack.

*Outside of field replaceable O₂ sensor, please contact INFICON service center to repair, calibrate or replace any CO and NO Sensor.

4.8 Bluetooth® connection

The **FLUE-Mate** analyzer is internally equipped with a Bluetooth® module, which allows the communication with a remote Bluetooth® printer and with the FLUE-Mate mobile app.

The maximum transmission range in open field is 100 meters (Class 1 Bluetooth® module), provided that also the communication companion is equipped with a Class1 Bluetooth® interface.

This solution allows great freedom of movement for the operator who is no longer bound directly to the instrument for acquisition and analysis, with significant advantages for many applications.

FLUE-Mate mobile app

With this mobile app, it is possible to scan the QR code generated by the instrument in order to download the data of the performed analyses. You can also watch the current analysis live, as it is being performed. To do this you have to first pair the app and the instrument.

The Bluetooth® word mark and logos are registered trademarks owned by Bluetooth SIG, Inc. and any use of such marks by INFICON is under license. Other trademarks and trade names are those of their respective owners.

Apple and the Apple logo are trademarks of Apple Inc., registered in the U.S. and other countries. Google Play is a trademark of Google LLC.

5.0 COMPONENTS DESCRIPTION

5.1 Instrument interface

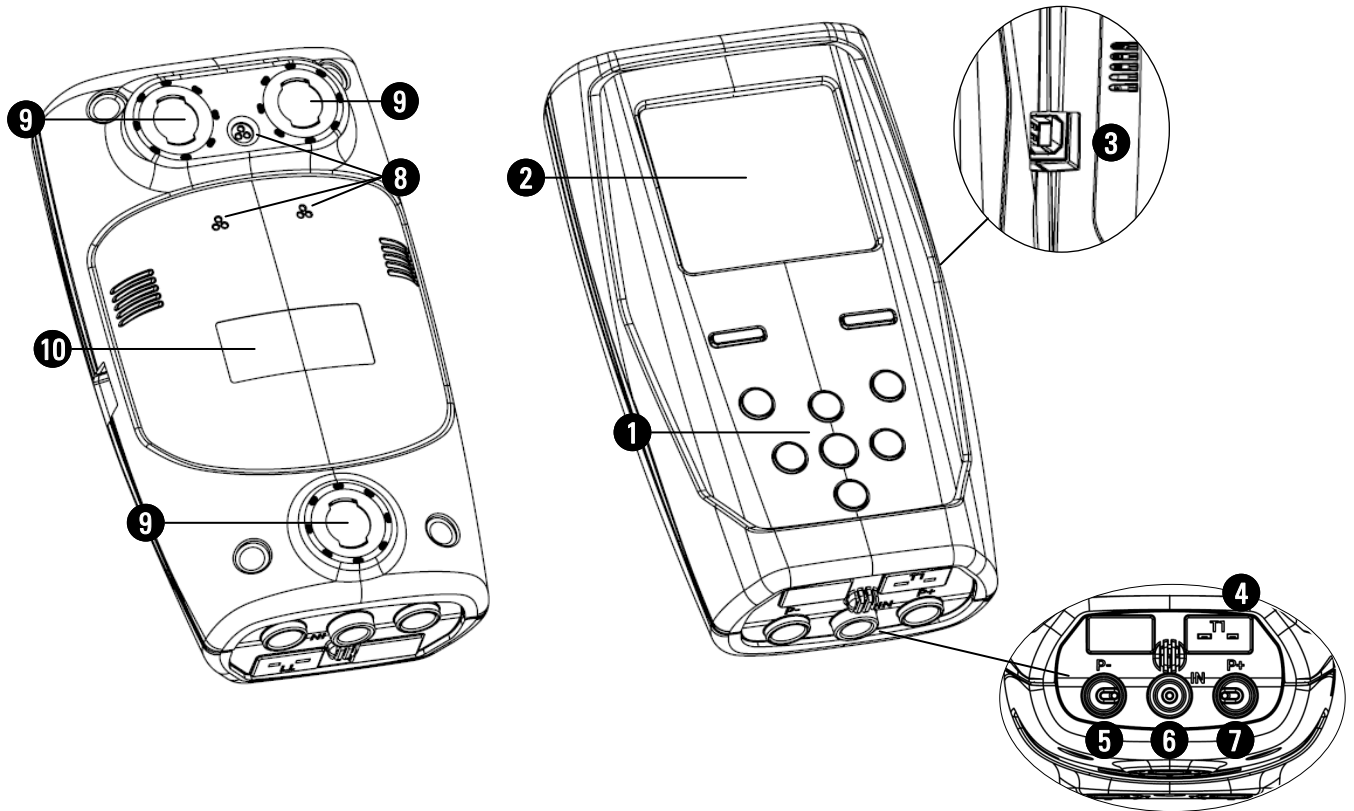

DESCRIPTION:

1 Button functions:

KEYS	FUNCTION
	Activates the context keys shown on the display.
	<ul style="list-style-type: none"> - Turns on and off the instrument. - If pressed briefly, accesses the instrument menu. - If pressed for at least 2 seconds, turns off the instrument.
	Exits the current screen.
	Confirm settings.
	Select and/or Modify.

2 Display

LCD backlit Display, White/Black 128 x 128 pixel with white LEDs.

CAUTION:

If the instrument is exposed to extremely high or extremely low temperatures, the quality of the display may be temporarily impaired. Display appearance may be improved by adjusting the contrast.

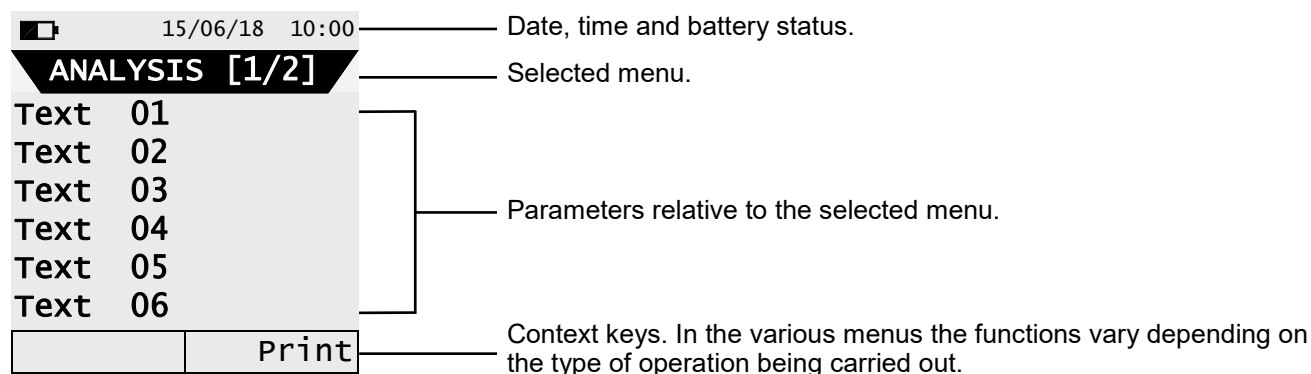

3 B-Type USB connector

Connector to connect the device to a personal computer or to the battery charger. The device comes with a wall charger with 5V DC, 2A output to charge the internal batteries.

4 'T1' Connector

Used to connect the Tc-K male connector of the gas temperature probe.

5 'P-' pneumatic connector

Negative input (P-) to be used for the connection of the gas aspiration probe.

6 'IN' pneumatic connector

Input for the connection of the branch of the gas sampling probe with the condensation separating and anti-dust filter assembly.

7 'P+' pneumatic connector

Positive input (P+): For draft measurement.

8 Gas exhaust

9 Magnets

10 Instrument data label.

6.0 TECHNICAL SPECIFICATIONS

6.1 Technical specifications

Power:	Li-Ion battery pack with internal protection circuit.
Average life of the battery package:	500 empty / full charge cycles.
Battery charger:	External 5Vdc 2A battery charger with female A-type USB connector + connection to the device with the supplied USB cable
Charging time:	5 hours to charge from 0% to 90% (6 hours for 100%). If charging with a PC, the device must be turned off. PC charging time will vary depending on the output current from the PC.
Instrument working time:	8 hours of non-stop operation with display brightness at 50%.

Display:	Graphic white LED backlit White / Black, 128 x 128 pixel
----------	--

Connectivity:

Communication port:	USB connector type B.
Bluetooth® (if the version of the instrument foresees it):	Class 1. Communication distance <100 meters (in open field)
Infrared interface:	For external printer (optional) using protocol HP-IR.

Autozero/Clean Air Acquisition:	Adjustable (30 - 600 seconds)
---------------------------------	-------------------------------

Gas measurement sensors:	Up to 3 electrochemical sensors
Type of combustible:	13 predefined by the factory.

Self-diagnosis:	Checks all functions and internal sensors and reports any abnormal operation.
Temperature measurement:	Input for thermocouple type K with mignon connector (ASTM E 1684-96) for the temperature measurement.
Room temperature measurement:	Through the internal sensor and/or acquisition through the gas probe positioned in air.

Internal data memory:	5 complete analyses.
-----------------------	----------------------

Suction pump:	0.26 gal. per minute (1.0 l/min) heads at the flue up to 80hPa.
---------------	---

Condensate trap:

Type:	Outside the instrument.
Line filter:	With replaceable cartridge, 99% efficient with 20um particles.

Condensing boiler efficiency:	Automatic recognition of the condensing boiler, with calculation and printout of efficiency (>100%) on the LHV (Lower Heating Value).
Environmental gases:	Measurement and separate printout of the ambient CO values.
Draft test:	By using the internal sensor connected to the port P+.

Operating temperature range:	23°F - 113°F (-5°C - +45°C)
Storage temperature range:	-4°F - 122°F (-20°C - +50°C)
Humidity limit:	20% - 80% RH
Protection grade:	IP42
Air pressure:	Atmospheric
Outer dimensions:	Analyzer: 3.2 x 2.0 x 6.3 inches (8.2 x 5.2 x 16 cm) (Width x Depth x Height)
	Case: 15.7 x 11.4 x 4.7 inches (40 x 29 x 12 cm) (Width x Depth x Height)

Weight:	Analyzer: ~ 12.3 Oz (350 g)
---------	-----------------------------

6.2 Measurement and accuracy ranges

MEASUREMENT	SENSOR	RANGE	RESOLUTION	ACCURACY	RESPONSE TIME T90
O ₂	Electrochemical sensor	0 - 25.0% vol	0.1% vol	±0.2% vol	<20 sec.
CO high H ₂ immunity with NO _x filter	Electrochemical sensor	0 - 4000 ppm	1 ppm	±20 ppm ±5% measured value	0 to 400 ppm 401 to 4000 ppm <30 sec.
NO	Electrochemical sensor	0 - 2000 ppm	1 ppm	±5 ppm ±5% measured value ±10% measured value	0 to 100 ppm 101 to 1000 ppm 1001 to 2000 ppm <40 sec.
NO _x	Calculated				
CO ₂	Calculated	0 - 99.9% vol	0.1% vol		
Air temperature	TcK sensor	-4.0 - 248.0 °F -20.0 - 120.0 °C	0.2 °F 0.1 °C	±1.8 °F ±1 °C	<30 sec.
Flue gas temperature	TcK sensor	-4 - 1472 °F -20.0 - 800.0 °C	0.2 °F 0.1 °C	±1.8 °F ±1 °C ±1% measured value	-4 to 212 °F -20 to 100 °C 212.2 to 1472 °F 101 to 800 °C <30 sec.
Pressure (draft & differential)	Piezoelectric sensor	-40 - 80 "H ₂ O	0.004 "H ₂ O	±1% measured value ±0.008 "H ₂ O ±1% measured value	-40 to -0.81 "H ₂ O -0.8 to +0.8 "H ₂ O +0.81 to +80 "H ₂ O <10 sec
Differential temperature	Calculated	32 - 1472.0 °F 0 - 800.0 °C	0.2 °F 0.1 °C		
Air index	Calculated	0.00 - 9.50	0.01		
Excess air	Calculated	0 - 850 %	1 %		
Stack loss	Calculated	0.0 - 100.0 %	0.1 %		
Efficiency	Calculated	0.0 - 100.0 %	0.1 %		
Efficiency (condensing)	Calculated	0.0 - 120.0 %	0.1 %		

7.1 Preliminary operations

Remove the instrument from its packing and check it for damage. Make sure that the content corresponds to the items ordered. If signs of tampering or damage are noticed, notify the INFICON service center or agent immediately and keep the original packing. A label at the rear of the analyzer bears the serial number. This serial number should always be stated when requesting technical assistance, spare parts or clarification on the product or its use.

Before using for the first time we recommend you charge the batteries completely.

7.2 Warning

- Use the instrument with an ambient temperature between 73 and 113°F (-5 and +45°C).



IF THE INSTRUMENT HAS BEEN KEPT AT VERY LOW TEMPERATURES (BELOW OPERATING TEMPERATURES) WE SUGGEST WAITING A WHILE (1 HOUR) BEFORE SWITCHING IT ON TO HELP THE SYSTEM'S THERMAL BALANCE AND TO PREVENT CONDENSATE FORMING IN THE PNEUMATIC CIRCUIT.

- Do not extract flue gas samples directly without using a particulate/water trap.
- Do not use the instrument if the filters are clogged or damp.
- Do not exceed sensor overload thresholds.
- After use, before turning the instrument off, remove the probe and let it aspirate ambient clean air for at least 30 seconds to purge the pneumatic path from all traces of gas.
- Before putting the measuring probe back in its case after use, make sure it has cooled down enough and there is no condensate in the tube. It might be necessary to periodically disconnect the filter and the condensate separator and blow compressed air inside the tube to eliminate all residues.
- Remember to have the instrument checked and calibrated once a year in order to comply with the existing standards.

7.3 Analyzer power supply

The instrument contains a high-capacity Li-Ion rechargeable battery.

The instrument runs for approximately 8 hours if the printer is not used and with display brightness at 50%. If the battery is too low for proper operation, the instrument can be plugged in with the wall charger.

The battery will be recharged while the instrument is being used.

The battery charging cycle takes up to 8 hours for a complete charge and finishes automatically.

ATTENTION: If the instrument is not going to be used for a long time (for example summertime) we suggest recharging it completely at least once every 4 months.

7.3.1 Internal battery charge level

The display constantly shows the internal battery charge level shown with the symbol in the upper left corner of the display.

SYMBOL	BATTERY CHARGE LEVEL
	100%
	80%
	60%
	40%
	20% It's advisable to recharge the battery.
	Dead battery Recharge the battery - The instrument may not function correctly.



THE INSTRUMENT IS SHIPPED WITH THE 30% OF BATTERY LIFE, ACCORDING TO CURRENT AIR TRANSPORTATION STANDARDS. IT IS ADVISABLE TO RECHARGE IT COMPLETELY BEFORE USE, TAKING 8 HOURS (ONE NIGHT).

IT IS ADVISABLE TO CHARGE THE BATTERY AT AN AMBIENT TEMPERATURE RANGING BETWEEN 50°F AND 86°F (10°C AND 30°C).

According to the charging level of the battery, the instrument can be left in stock for a time correlated to the battery level itself. Below, a table that explains the correlation between battery charging level and stock time.

BATTERY CHARGE LEVEL	STOCK TIME
100%	110 days
75%	80 days
50%	45 days
25%	30 days

7.3.2 Use with wall charger

The instrument can work with the batteries fully discharged by connecting the wall charger provided.



**THE POWER SUPPLY/BATTERY CHARGER IS A SWITCHING TYPE ONE.
THE APPLICABLE INPUT VOLTAGE RANGES BETWEEN 90Vac AND 264Vac.
INPUT FREQUENCY: 50-60Hz.
THE LOW VOLTAGE OUTPUT IS 5 VOLT WITH AN OUTPUT CURRENT GREATER THAN 1.5A.
LOW VOLTAGE POWER CONNECTOR: A-TYPE USB CONNECTOR + CONNECTION CABLE WITH B-TYPE PLUG.**

7.4 QR code generation

The instrument can generate a QR code for easy viewing, saving, and sharing of analysis data on the FLUE-Mate mobile app, available on the App Store® or on Google Play™. This function is enabled with the setting "QR Code" in the "Print" menu.

Minimum requirements for the FLUE-Mate mobile app.

Operating systems: Android from version 4.1
 Apple (iOS)



THE INSTRUMENT WILL GENERATE THE QR CODE ONLY IF THE INTERACTIVE FUNCTION "PRINT" IS SHOWN.

7.5 Connection diagram

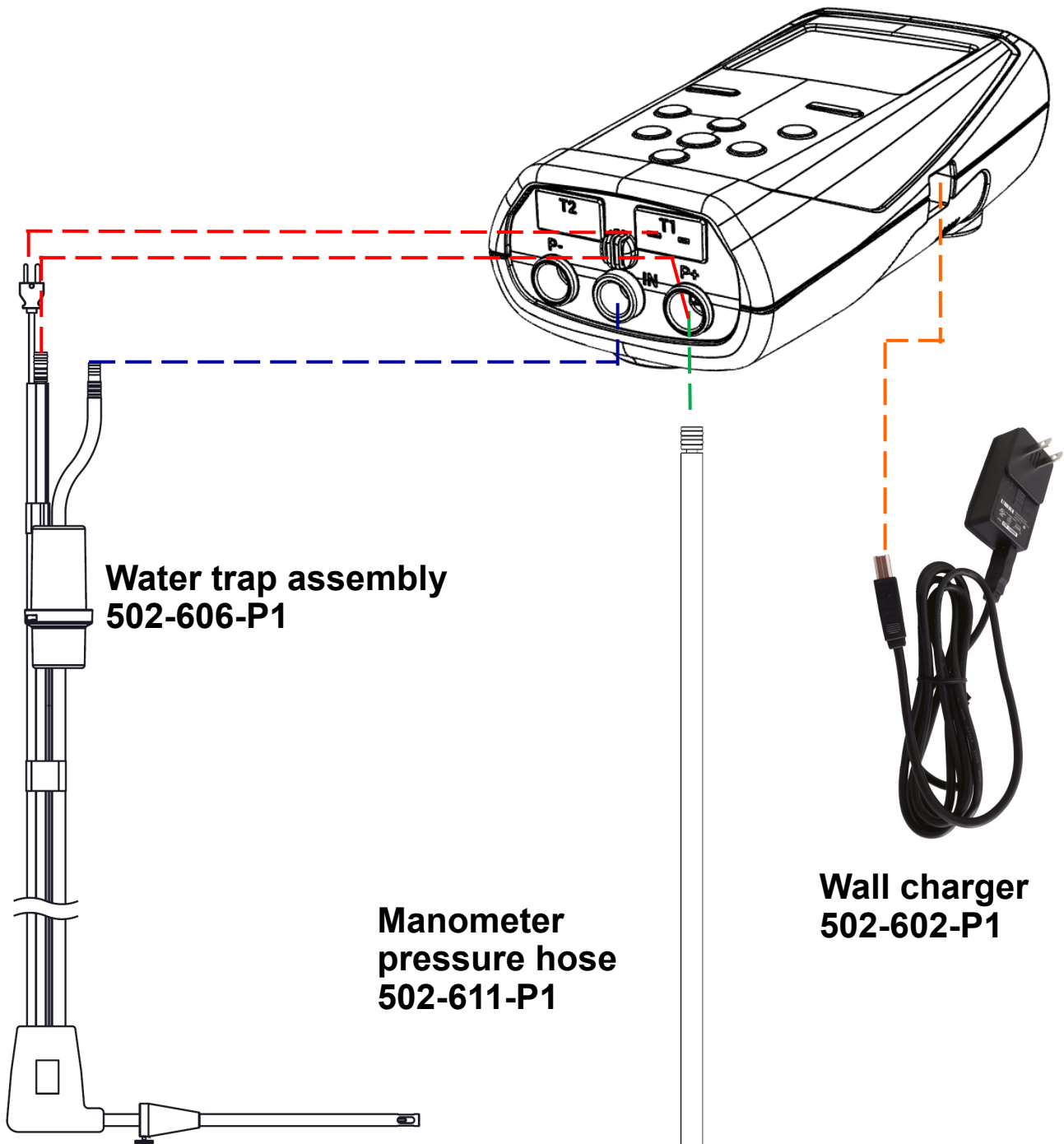

8.1 Flue gas analysis



To perform complete flue gas analysis, follow the instructions below.

SOME IMPORTANT WARNINGS TO CONSIDER DURING THE COMBUSTION ANALYSIS ARE LISTED BELOW:

FOR A CORRECT ANALYSIS NO AIR MUST FLOW INTO THE PIPE FROM OUTSIDE DUE TO A BAD TIGHTENING OF THE POSITIONING CONE OR A LEAK IN THE PIPELINE.

THE GAS PIPE MUST BE CHECKED IN ORDER TO AVOID ANY LEAKAGES OR OBSTRUCTIONS ALONG THE PATH. THE CONNECTORS OF THE GAS SAMPLING PROBE AND OF THE CONDENSATION FILTER MUST BE WELL CONNECTED TO THE INSTRUMENT. KEEP THE CONDENSATION TRAP ON VERTICAL POSITION DURING THE ANALYSIS; A WRONG POSITIONING MAY CAUSE CONDENSATE INFILTRATIONS IN THE INSTRUMENT AND THUS DAMAGE THE SENSORS. AFTER EACH ANALYSIS CHECK FOR ANY PRESENCE OF WATER IN THE CONDENSATE COLLECTION BOWL AND REMOVE IT IF ANY. PUT THE PROBE BACK IN THE CASE ONLY AFTER YOU HAVE ELIMINATED CONDENSATE FROM THE TUBE AND THE EXPANSION TANK (SEE CHAPTER 'MAINTENANCE'). REPLACE THE FINE DUST FILTER IF IT IS VISIBLY DIRTY OR WET (SEE CHAPTER 'MAINTENANCE'). DO NOT PERFORM ANY MEASUREMENT WHEN THE FILTER IS REMOVED OR DIRTY IN ORDER TO AVOID ANY RISK OF IRREVERSIBLE DAMAGES TO SENSORS AND ANALYZER ITSELF.

8.1.1 Turning on the instrument and auto-calibration

BEFORE TURNING ON THE INSTRUMENT:

- **CONNECT THE GAS SAMPLING PROBE TO THE INSTRUMENT.**
- **STORING OF THE AMBIENT TEMPERATURE: UPON COMPLETION OF THE AUTOZERO IN FRESH OUTDOOR AIR, PRESS THE “KEEP” BUTTON TO STORE THE OUTSIDE TEMPERATURE BEING USED FOR PRIMARY AIR. IF THE Tc-K CONNECTOR IS NOT PLUGGED IN, THE TEMPERATURE WILL NOT BE ACQUIRED.**

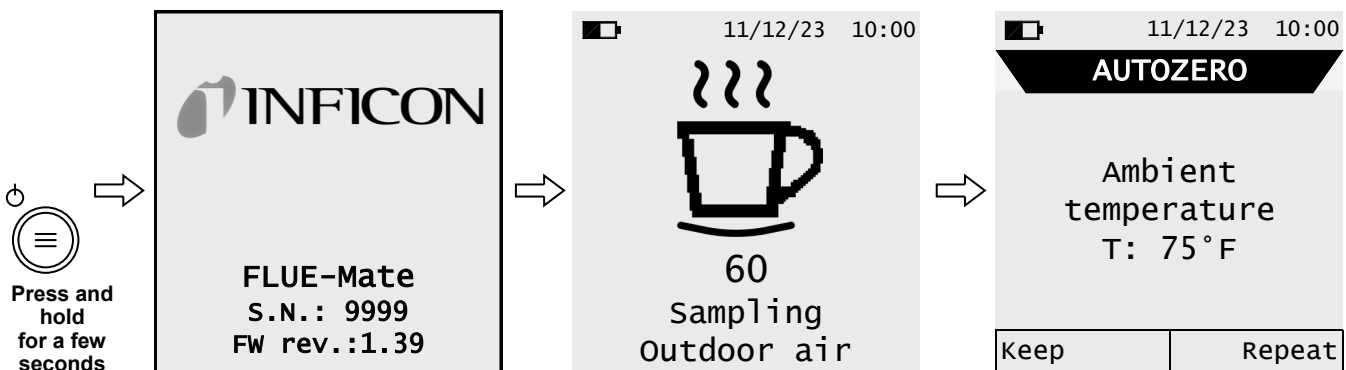

↓

28/03/23 09:14AM

HARDWARE

- ▶ Recall KO
- Calibration KO
- voltages
- ADC channels

WARNING!

When the instrument is turned on, a hardware check is performed on the memories and on the instrument calibration. If some error occurs, they will be shown with the activation of the **Hardware** screen. In this case, it is advisable to restart the instrument. If the problem keeps on appearing or frequently occurring please contact the INFICON service center, communicating the shown error.

When the autozero (sampling outdoor air) phase is complete, push the key related to the interactive function “**Keep**”, to proceed with the combustion analysis or push the key related to the interactive function “**Repeat**”, to acquire a new ambient air sample.



8.1.2 Preliminary operations

Following are the parameters to set before performing the combustion analysis:

<div style="border: 1px solid black; padding: 5px;"> <p style="text-align: center;">15/06/18 10:00</p> <p style="text-align: center;">ANALYSIS [1/2]</p> <table style="width: 100%; border-collapse: collapse;"> <tr><td>O2</td><td style="text-align: right;">7.1 %</td></tr> <tr><td>CO</td><td style="text-align: right;">15.4 p</td></tr> <tr><td>CO2</td><td style="text-align: right;">4.2 %</td></tr> <tr><td>Eff</td><td style="text-align: right;">23 %</td></tr> <tr><td>Loss</td><td style="text-align: right;">2.9 %</td></tr> <tr><td>Tf</td><td style="text-align: right;">---- F</td></tr> </table> <table style="width: 100%; border-collapse: collapse; margin-top: 5px;"> <tr> <td style="width: 50%; border-right: 1px solid black; padding: 2px;">Save</td> <td style="padding: 2px;">Print</td> </tr> </table> </div>	O2	7.1 %	CO	15.4 p	CO2	4.2 %	Eff	23 %	Loss	2.9 %	Tf	---- F	Save	Print	<div style="border: 1px solid black; padding: 5px;"> <p style="text-align: center;">11/12/17 10:00</p> <p style="text-align: center;">MENU</p> <ul style="list-style-type: none"> ▶ Sample type Recall Setup Service Help </div>	<div style="border: 1px solid black; padding: 5px;"> <p style="text-align: center;">11/12/17 10:00</p> <p style="text-align: center;">SAMPLE TYPE</p> <ul style="list-style-type: none"> ▶ Comb. analysis Draft CO air Pressure </div>
O2	7.1 %															
CO	15.4 p															
CO2	4.2 %															
Eff	23 %															
Loss	2.9 %															
Tf	---- F															
Save	Print															

BEFORE PERFORMING THE COMBUSTION ANALYSIS, SET THE NECESSARY PARAMETERS ([SEE CHAPTER 12.2](#)).

8.1.3 Inserting the probe inside the stack

When the outdoor air sampling is over, insert the flue gas probe into the stack. In order for the probe to be inserted at the right point within the stack, its distance from the boiler has to be twice the diameter of the stack pipe itself or, if this is not possible, must comply with the boiler manufacturer’s instructions.

If not already present, drill a 1/4 in. (~6.5 mm) hole in the stack and screw in the positioning cone provided with probe. This ensures that no air is drawn from the outside during sampling.

The screw on the cone allows the probe to be stopped at the right measuring depth - this usually corresponds to the center of the flue pipe. For greater positioning accuracy, the user may insert the probe gradually into the pipe until the highest temperature is read.

The exhaust pipe must be inspected before carrying out the test to ensure that no constrictions or losses are present in the piping or stack.

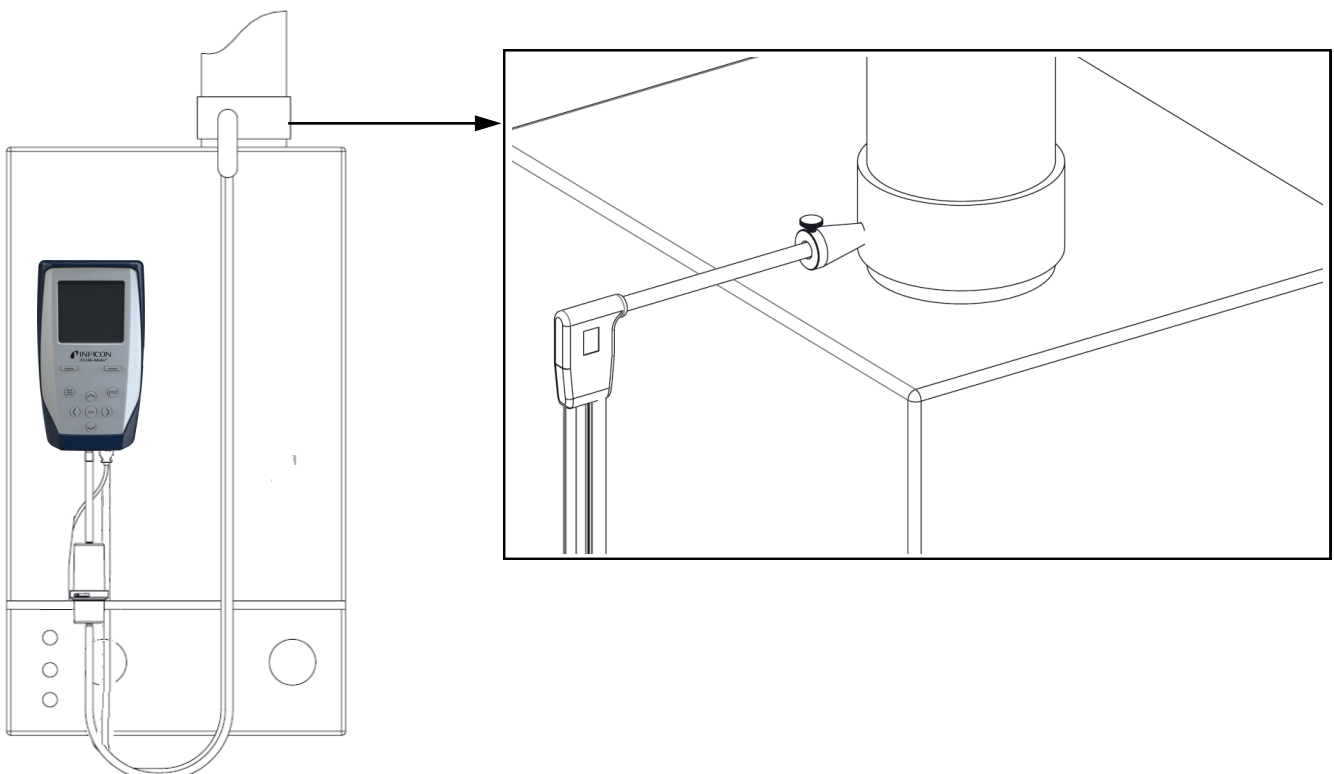



8.1.4 Performing the combustion analysis - Manual Mode

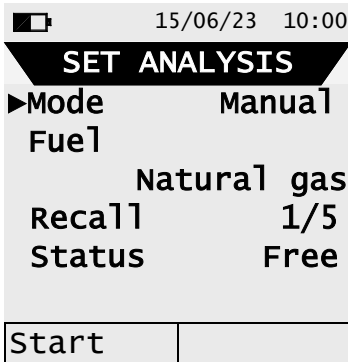

Start

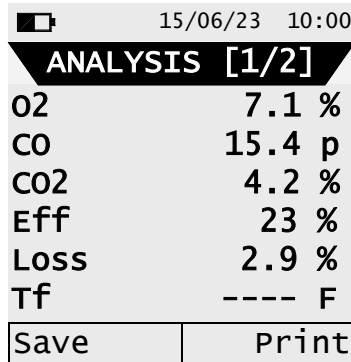

Print

Save

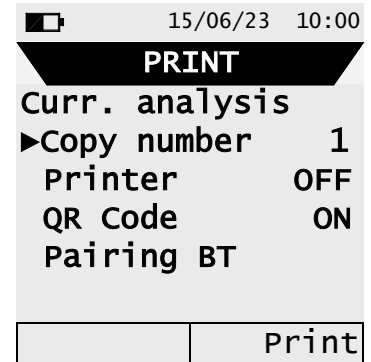

Print

IN THIS SCREEN IT IS POSSIBLE TO MODIFY THE NUMBER OF THE MEMORY IN WHICH THE CURRENT ANALYSIS IS BEING SAVED.
(SEE CHAPTER 11.0)

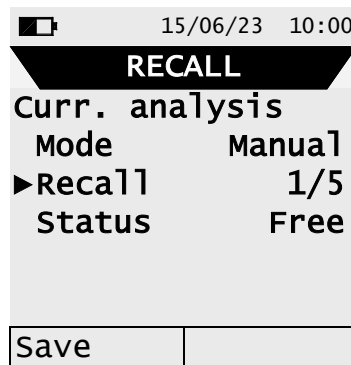

Save

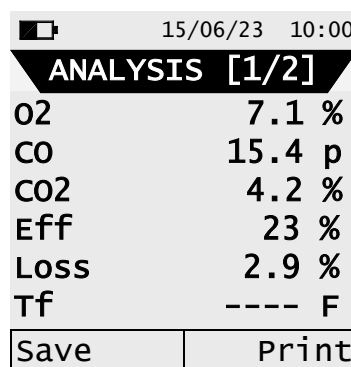



8.1.5 Performing the combustion analysis - Auto Mode

15/06/23 10:00	
SET ANALYSIS	
►Mode	Auto
Fuel	Natural gas
Interval	7 s
Memory	1/5
Start	

Start

15/06/23 10:00	
ANALYSIS [1/3]	
Tf	190.1 C
Ta	15.4 C
O2	4.2 %
CO	23 ppm
CO2	2.9 %
CO _r	---- p
Pause	1/3 7

Automatically stores the first sample when the interval time is over.

15/06/23 10:00	
ANALYSIS [1/3]	
Tf	190.1 C
Ta	15.4 C
O2	4.2 %
CO	23 ppm
CO2	2.9 %
CO _r	---- p
Pause	2/3 7

Automatically stores the second sample when the interval time is over.

15/06/23 10:00	
ANALYSIS [1/3]	
Tf	190.1 C
Ta	15.4 C
O2	4.2 %
CO	23 ppm
CO2	2.9 %
CO _r	---- p
Pause	3/3 7

Automatically stores the third sample when the interval time is over.

15/06/23 10:00	
AVERAGE [1/3]	
Tf	190.1 C
Ta	15.4 C
O2	4.2 %
CO	23 ppm
CO2	2.9 %
CO _r	---- p
	Print

Print



- SCAN THE QR CODE WITH THE FLUE-Mate MOBILE APP IN ORDER TO DOWNLOAD THE ACQUIRED DATA. THE VISUALIZED QR CODE IS REFERRING ONLY TO THE AVERAGE OF THE PERFORMED ANALYSIS.
- TO PRINT THE AVERAGE ANALYSES AND ADDITIONAL MEASURES TICKET, ENABLE THE PRINTER IN THE MENU "SETUP→PRINT".
- TO PRINT THE COMPLETE ANALYSIS AND THE PERFORMED MEASURES, ENTER THE "RECALL" MENU, SELECT THE RELATED MEMORY NUMBER AND PUSH THE INTERACTIVE FUNCTION KEY "PRINT".
- TO DOWNLOAD THE SINGLE ANALYSIS DATA, ENTER THE "RECALL" MENU, SELECT THE RECALL NUMBER USED TO SAVE THE ANALYSES THEN SELECT ONE AT A TIME THE SINGLE ROWS. (SEE CHAPTER 11.0).



Additional information

INTERACTIVE OPERATION	DESCRIPTION
<div style="border: 1px solid black; padding: 2px; display: inline-block;">Pause</div>	By pushing the button related to this interactive function, the instrument stops the current analysis when the set time interval is over. This condition is shown with the symbol " <div style="border: 1px solid black; padding: 2px; display: inline-block;">Paused</div> ".
<div style="border: 1px solid black; padding: 2px; display: inline-block;">Keep</div>	When the "Paused" phase is over, the interactive function "Keep" is shown. By activating this function the acquired sample is memorized and the instrument continues with the acquisition of the next sample.



PRESS THE  BUTTON AT ANY TIME TO INTERRUPT THE COMBUSTION ANALYSIS AND GO BACK TO THE MAIN SCREEN.



8.1.6 End of the analysis

- At the end of the combustion analysis, carefully remove the sample probe from the stack. CAUTION: The probe will be hot.
 - Turn off the instrument.
The instrument will execute a cleaning cycle, according to what's set in the menu "SETUP→ANALYSIS→AUTOZERO→PURGE", during which the pump sucks clean air until reducing the concentration of CO. The instrument automatically turns off within max. 10 minutes.
- Note: It is always advisable to purge the instrument with clean air for 5 - 10 minutes before turning it off.



WHEN THE GAS SAMPLING PROBE IS TAKEN OUT OF THE STACK, THE FORMATION OF SOME CONDENSATION IN THE PROBE TUBE AND IN THE ANTI-CONDENSATION TRAP MAY OCCUR.

IT IS ADVISED TO ACCURATELY CLEAN EVERY PART BEFORE PUTTING AWAY THE PROBE AND THE ANTI-CONDENSATION TRAP IN THE CASE.

IN ORDER NOT TO DAMAGE THE CASE MAKE SURE THAT THE METALLIC PROBE PIPE HAS COOLED TO BELOW 140°F (60°C).

Gas sampling probe cleaning

- When you finish using the sample probe clean it thoroughly as described below before returning it to its case:
 - Disconnect the sample probe from the instrument and from the water trap (Fig. a-b) then blow a jet of clean air into the hose of the probe (refer to Fig. b) to remove any residual condensate that may have formed within.

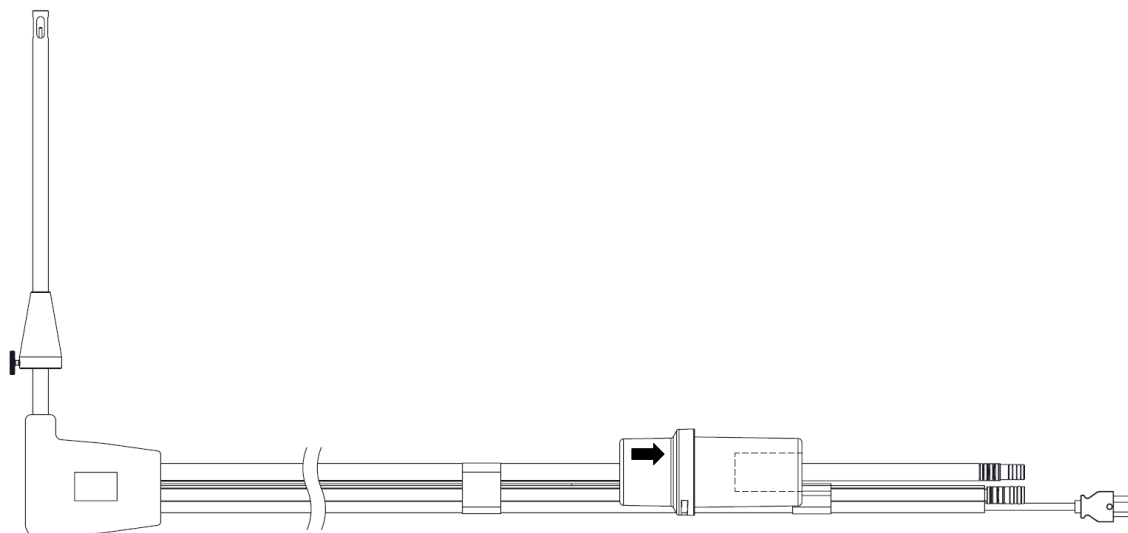

Fig. a

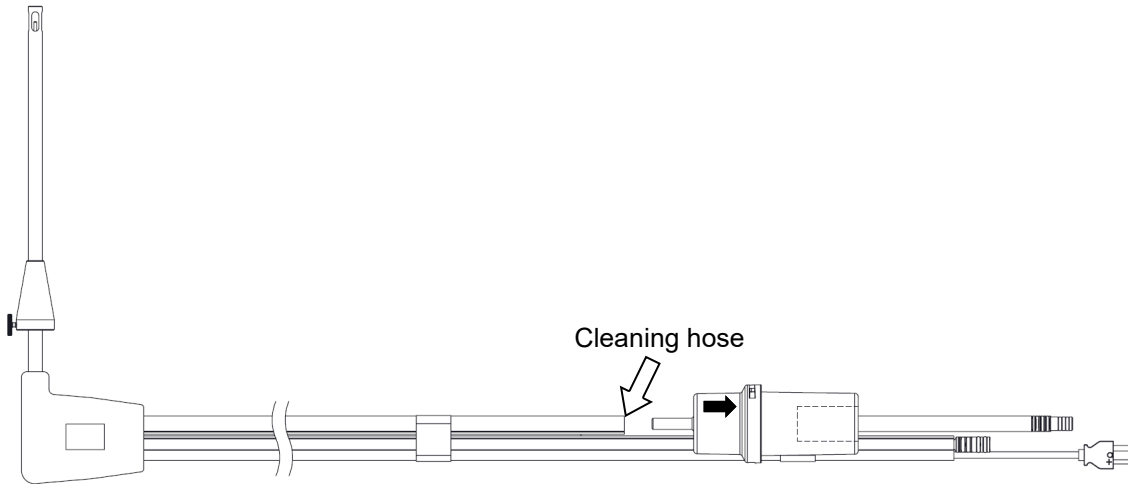
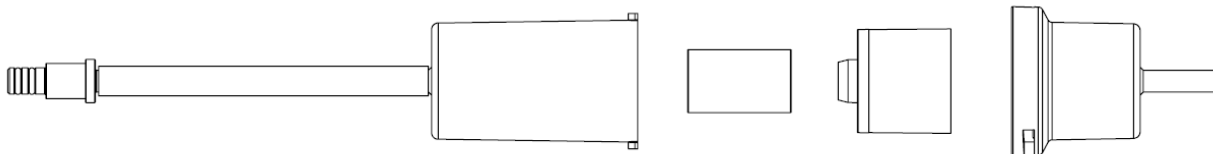

Fig. b

Maintaining the water trap / filter unit

To remove the water trap, rotate the cover and unhook the filter holder body; remove the internal cup and then replace the filter (see figure on the side).
Clean all the filter parts using water only, dry the components and reassemble the filter.



Replacing the particulate filter (Part # 502-603-P1)

If the particulate filter appears black, especially on the inner surface (see adjacent example), it has to be replaced immediately. In this way gas flow is not obstructed.

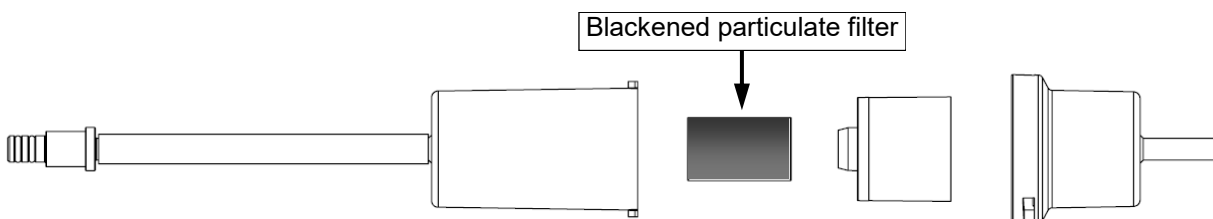

9.1 Menu



KEY	FUNCTION
	Returns to the previous screen.
	Selects the available parameters.
	Enters in the selected parameter setting.

SUB-MENU	FUNCTION
Sample type	Through this sub-menu, it is possible to execute the combustion analysis, draft, ambient CO and pressure measurement. SEE CHAPTER 10.0
Recall	This sub-menu can select a memory location for saving or reviewing data. Moreover, it shows the status (Full or Free) and the details (time and date) of the selected memory number (if the memory position is occupied by some data). It can also visualize, print or delete the memorized data and the additional measures. SEE CHAPTER 11.0
Setup	The user can set the different reference parameters of the instrument in order to perform the combustion analysis. SEE CHAPTER 12.0
Service	The user can verify any anomalies of the instrument. SEE CHAPTER 13.0
Help	Display the info about the current condition of the instrument. SEE CHAPTER 14.0

10.0 SAMPLE TYPE

10.1 Menu→Sample type

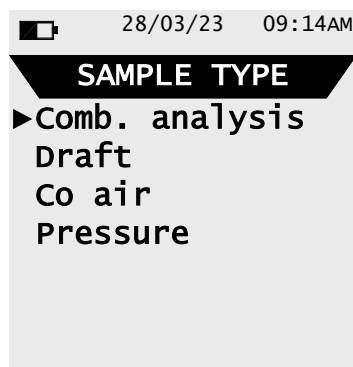

KEY	FUNCTION
	Returns to the previous screen.
	Selects the available parameters.
	Enters in the selected parameter setting.

SUB MENU	FUNCTION
Comb. analysis	The user, with this menu, can set the different reference parameters of the instrument to perform the combustion analysis. SEE CHAPTER 10.2
Draft	The DRAFT menu gives access to the stack draft measurement. NOTE: The measurement may not be accurate due to condensation inside the gas probe. Should you notice an inaccurate or unstable reading on the instrument, it is advisable to disconnect the gas probe from the instrument, and purge pipes by blowing with compressed air. To ensure there is no humidity, it is suggested to perform the measurement by means of the transparent rubber pipe supplied on issue. SEE CHAPTER 10.3
CO air	This type of analysis lets the user measure the CO value present in the ambient environment, with the scope of checking the personal safety conditions of a specific working environment. The instrument leaves our factory with the following pre-set threshold values: COmax: 35 ppm Recommended Exposure Limit (REL) stipulated by the National Institute for Occupational Safety and Health (NIOSH), equivalent to 40 mg/m ³ and calculated as an 8-hour Time-Weighted Average (TWA).  Always perform the autozero in the clean air so that the ambient CO measurement is correct. It is advisable to turn on the instrument and wait for the autozero completion outside the area where the test is being performed. SEE CHAPTER 10.4
Pressure	Through the use of the external flexible pipe made in RAUCLAIR (supplied) is possible to measure a pressure value within the range stated in the technical features (connect the pipe to P+ input). SEE CHAPTER 10.5

10.2 Menu→Sample type→Comb. analysis

15/06/18 10:00	
SET ANALYSIS	
▶Mode	Auto
Fuel	Natural gas
Interval	7 s
Memory	1/5
Status	Free
Start	

KEY	FUNCTION
	Activate the context keys shown on the display.
	Returns to the previous screen.
	Selects the available parameters.
	Enters the selected parameter and confirms the choice made.

INTERACTIVE OPERATION	FUNCTION
	Starts the analysis with the selected mode

PARAMETER	DESCRIPTION
Mode	<p>This menu allows the user to choose among 2 different analysis modes: Manual or Auto</p> <p>Manual: In manual mode, the combustion analysis is performed manually by prior setting the ' Fuel ' parameter. Then, the manual analysis can start but waiting, at the beginning, at least two minutes that the shown values are stable; at this moment it is possible to proceed with the memorization or directly to print depending on the setting made.</p> <p>Auto: In this mode it is possible to print or save just one combustion analysis containing all the data necessary to fill in the booklet of the system or plant. In this mode the instrument performs 3 different measures divided by a time gap defined by the user using the sub parameter ' interval '. Moreover, it is possible to select the memory in which is needed to store the analysis and set the used fuel.</p> <p>In all modes, the data displayed regarding the pollutants CO / NO / NO_x can be translated into normalized values (with reference to the concentration of O₂ previously set in "setup=> analysis" menu).</p>
Fuel	Allows the choice of the fuel to be analyzed. This data can be changed not only in this menu, but also in configuration menu.
Interval	ONLY IN 'AUTO MODE'. Sets the time interval for the sample acquisition with a value variable from 1 to 900 seconds.
Memory	ONLY IN 'AUTO MODE'. Allows to select the memory number where to save the analysis. If the memory is full it is possible to choose whether to overwrite the values of the analysis formerly acquired.



TO PERFORM THE COMBUSTION ANALYSIS REFER TO [CHAPTER 8.0](#)

10.3 Menu→Measurements→Draft

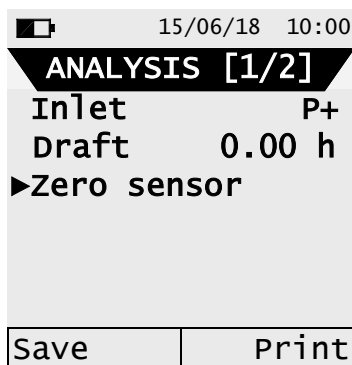

KEY	FUNCTION
	Activate the context keys shown on the display.
	Returns to the previous screen.
	Starts the pressure sensor autozero.

INTERACTIVE OPERATION	FUNCTION
Save	The measure will be printed on the ticket of the current combustion analysis
Print	According with the related setting, it is possible to print or visualize the QR code



To measure the draft:

- Connect the probe pressure input hose to the instrument **P+** input.
- Before starting the pressure zeroing sequence, remove the gas probe from the stack.
- After the pressure zeroing sequence, insert the probe in the stack and measure the draft.

Example:



10.4 Menu→Sample Type→CO air

15/06/18 10:00	
CO AIR	
CO	412 p
CO Max	413 p
Save	Print

KEY	FUNCTION
	Activate the context keys shown on the display.
	Returns to the previous screen.

INTERACTIVE OPERATION	FUNCTION
Save	The measure will be printed on the ticket of the current combustion analysis
Print	According with the related setting, it is possible to print or visualize the QR code



It is important to perform the outdoor air sampling in clean air, so that the ambient CO measurement is correct. It is advisable to turn on the instrument and wait for the autozero completion outside the area where the test is being performed.

Example:

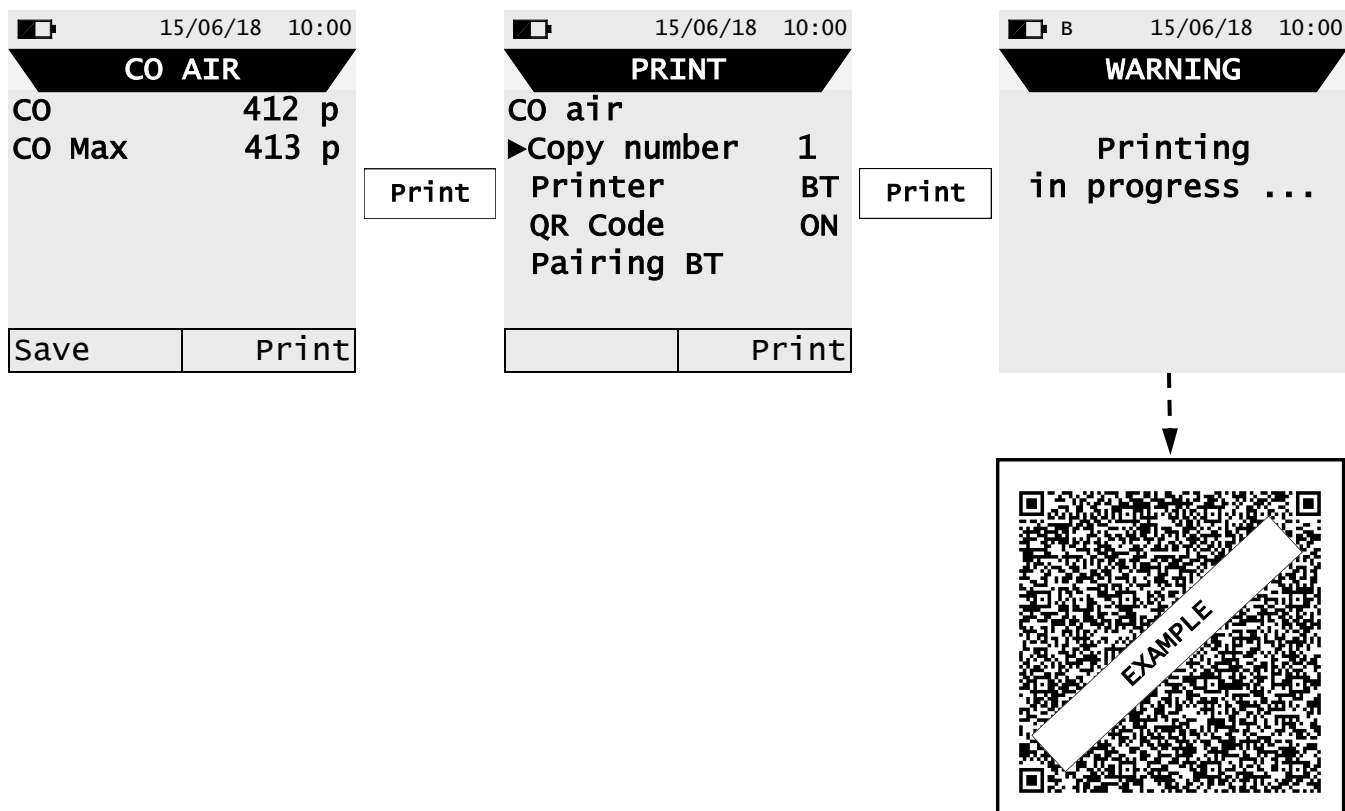

10.5 Menu→Sample type→Pressure



KEY	FUNCTION
	Activate the context keys shown on the display.
	Returns to the previous screen.
	Perform the Zero Sensor of the pressure sensor.

INTERACTIVE OPERATION	FUNCTION
Save	The measure will be printed on the ticket of the current combustion analysis
Print	According with the related setting, it is possible to print or visualize the QR code

Example:

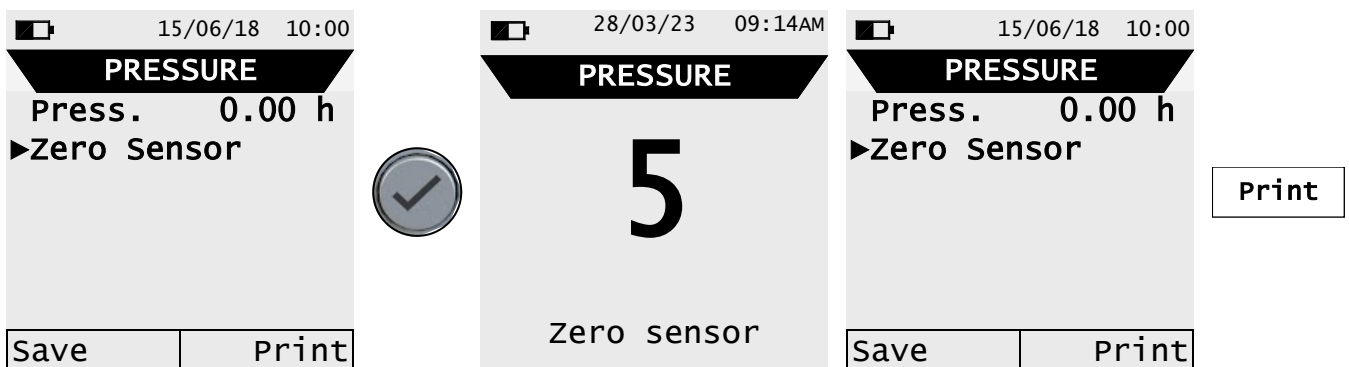

11.1 Menu→Recall

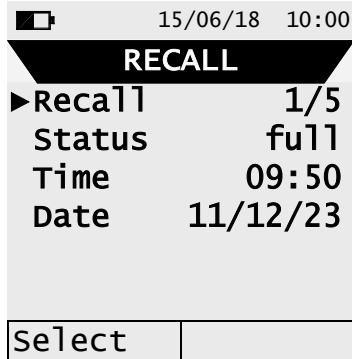

KEY	FUNCTION
	Activate the context keys shown on the display.
	Modifies the recall number and then confirms the changed setting. When selecting the analysis, shows the detail of the analysis.
	Selects the available parameters.
	Returns to the previous screen. In modification mode, cancels the setting made.

INTERACTIVE OPERATION	DESCRIPTION
Select	Shows the list of measures within the selected recall number.
Delete	Deletes the entire contents of the selected recall.
Print	Prints the ticket or shows the QR code of the selected memory number.

1. Set recall detail

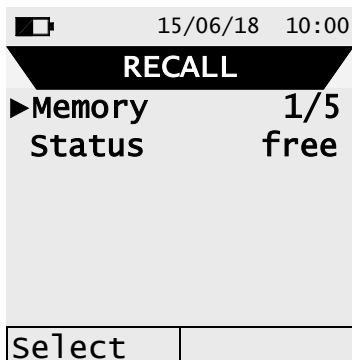
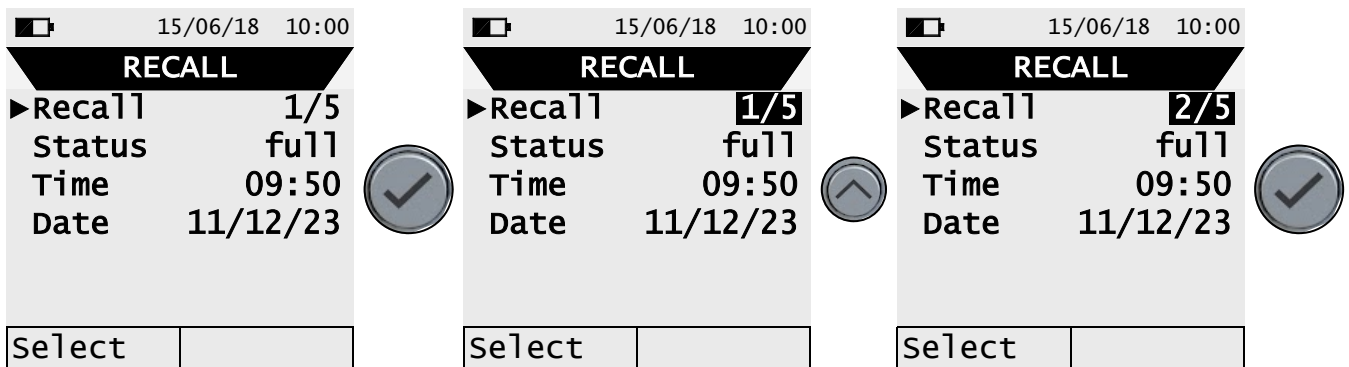

2. Visualization of the recall content

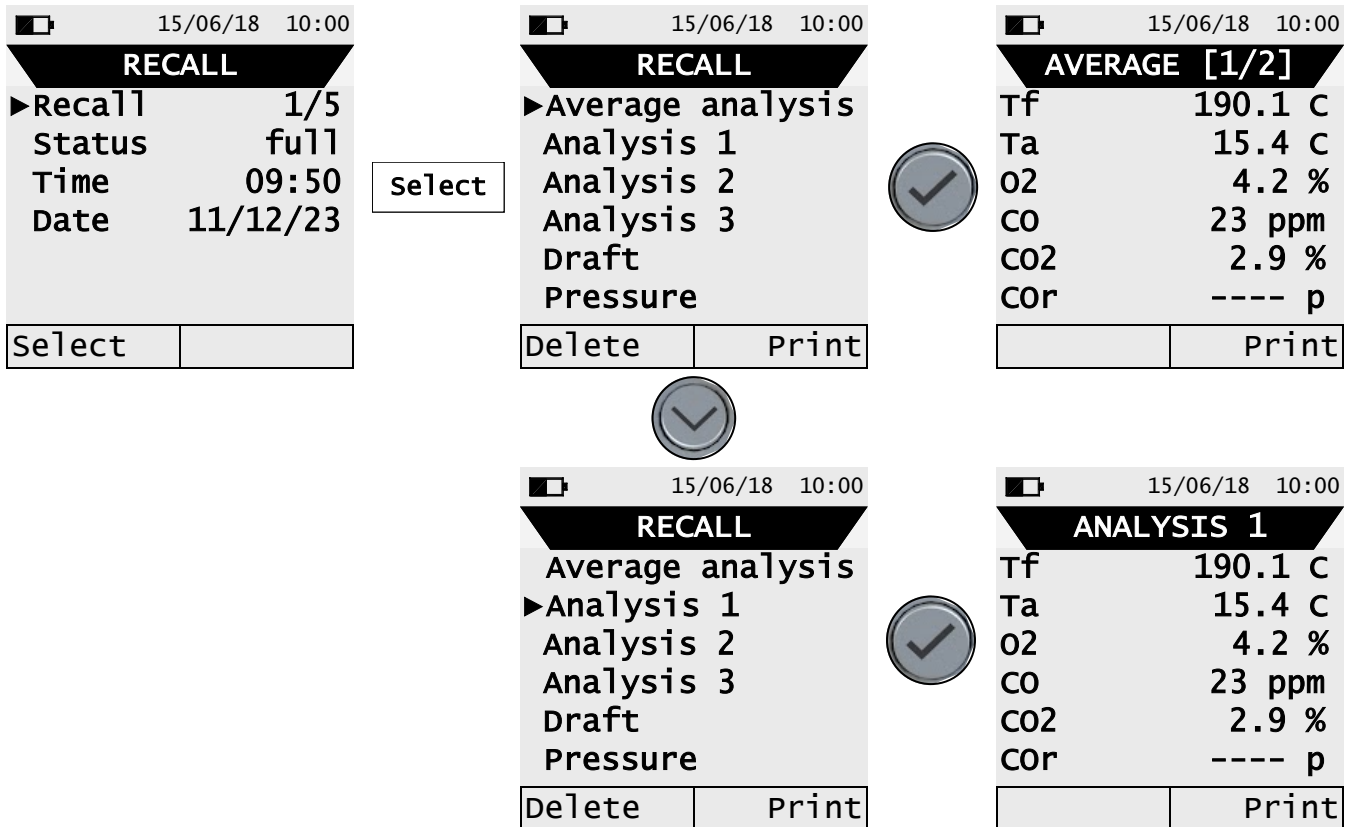

3. Print ticket detail of the entire selected recall

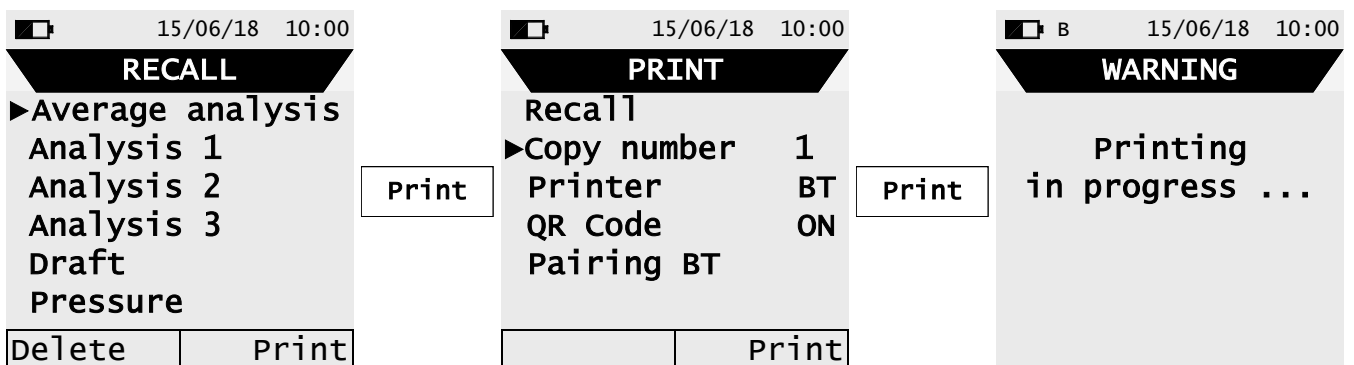

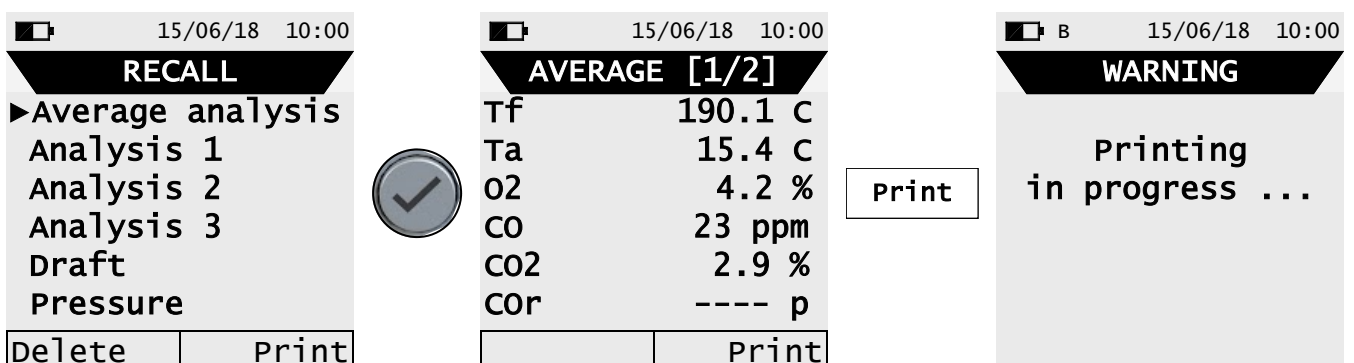

4. Print ticket detail of the single analysis / measure



5. Detail of QR code generation to download the average analysis data and the additional measures.

<div style="border: 1px solid black; padding: 5px;"> <p>15/06/18 10:00</p> <p>RECALL</p> <p>►Average analysis</p> <p>Analysis 1</p> <p>Analysis 2</p> <p>Analysis 3</p> <p>Draft</p> <p>Pressure</p> <p>Delete Print</p> </div>	Print	<div style="border: 1px solid black; padding: 5px;"> <p>15/06/18 10:00</p> <p>PRINT</p> <p>Memory</p> <p>►Copy number 1</p> <p>Printer OFF</p> <p>QR Code ON</p> <p>Pairing BT</p> <p>Print</p> </div>	Print	
---	-------	--	-------	---

6. Detail of QR code generation to download the data of each single analysis / measure

<div style="border: 1px solid black; padding: 5px;"> <p>15/06/18 10:00</p> <p>RECALL</p> <p>►Average analysis</p> <p>Analysis 1</p> <p>Analysis 2</p> <p>Analysis 3</p> <p>Draft</p> <p>Pressure</p> <p>Delete Print</p> </div>		<div style="border: 1px solid black; padding: 5px;"> <p>15/06/18 10:00</p> <p>AVERAGE [1/2]</p> <p>Tf 190.1 C</p> <p>Ta 15.4 C</p> <p>O2 4.2 %</p> <p>CO 23 ppm</p> <p>CO2 2.9 %</p> <p>CO_r ---- p</p> <p>Print</p> </div>	Print	<div style="border: 1px solid black; padding: 5px;"> <p>15/06/18 10:00</p> <p>PRINT</p> <p>Recall</p> <p>►Copy number 1</p> <p>Printer OFF</p> <p>QR Code ON</p> <p>Pairing BT</p> <p>Print</p> </div>	Print	
---	---	--	-------	--	-------	---

7. Detail of deleting the entire selected memory content

<div style="border: 1px solid black; padding: 5px;"> <p>15/06/18 10:00</p> <p>RECALL</p> <p>►Average analysis</p> <p>Analysis 1</p> <p>Analysis 2</p> <p>Analysis 3</p> <p>Draft</p> <p>Pressure</p> <p>Delete Print</p> </div>	Delete	<div style="border: 1px solid black; padding: 5px;"> <p>15/06/18 10:00</p> <p>RECALL</p> <p>Completely erase recall 1/5?</p> <p>Yes No</p> </div>	Yes	<div style="border: 1px solid black; padding: 5px;"> <p>15/06/18 10:00</p> <p>RECALL</p> <p>►Memory 1/5</p> <p>Status free</p> <p>Select</p> </div>
---	--------	---	-----	--

12.1 Menu→Setup



KEY	FUNCTION
	Enters in the selected parameter.
	Selects the available parameters.
	Returns to the previous screen.

SUB MENU	FUNCTION
Analysis	The user can set the different reference parameters of the instrument in order to perform the combustion analysis and/or additional measures. SEE CHAPTER 12.2
Instrument	The user can set the different reference parameters of the instrument. SEE CHAPTER 12.3
Alarm	<p>Alarm management - The user can set an alarm for a defined gas for programmable minimum or maximum thresholds. The Minimum alarm type will ring when the measured gas drops below the set threshold, while the Maximum alarm type will ring when the measured gas goes above the set threshold. If the alarm is in Off mode, it is deactivated.</p> <p>SEE CHAPTER 12.4</p>
Print	This menu allows the user to set the printing parameters, such as copy number, printer type (OFF or BT) and the visualization of the QR code so to download the data of the performed analysis. SEE CHAPTER 12.5
Language	Select the desired language of the instrument for all the menus. SEE CHAPTER 12.6
Restore	Reset default data. SEE CHAPTER 12.7

12.2 Menu→Setup→Analysis

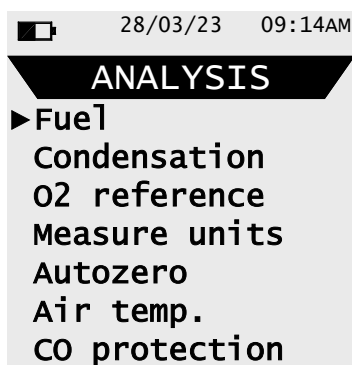

KEY	FUNCTION
	Returns to the previous screen.
	Selects the available parameters.
	Enters in the selected parameter.

SUB MENU	FUNCTION
Fuel	Lets the user select the type of fuel to be used during analysis. SEE CHAPTER 12.2.1.
Condensation	The burner efficiency figure when condensation takes place is influenced by atmospheric pressure and humidity of the combustion air. As the atmospheric pressure is hardly precisely known, the operator is asked to enter a related parameter, i.e. the altitude of the place above the sea level, from which the pressure is then derived once the dependency from atmospheric conditions is neglected. In calculations the value of 101325 Pa is assumed as atmospheric pressure at sea level. Further the air relative humidity input is allowed, being this calculated at the combustion air temperature as measured from the instrument; in case this value is unknown the operator is recommended to enter 50% for this value. SEE CHAPTER 12.2.2.
O₂ reference	In this mode the user can set the oxygen percentage level to which pollutant emission values detected during analysis will be referenced. SEE CHAPTER 12.2.3.
Measure units	The user can modify the units of measurement for all the analysis parameters, depending on how they are used. SEE CHAPTER 12.2.4.
Autozero	The user can modify the auto zero (sampling indoor air) cycle duration and the duration of the sensor cleaning cycle. SEE CHAPTER 12.2.5.
Air temp.	The user can acquire or manually enter the combustion air temperature. SEE CHAPTER 12.2.6
CO Protection	When set to ON, the pump will stop if the programmed LIMIT threshold is reached. This will help avoid damage to the sensor from excessive exposure to CO, extending the sensor life. The default setting is ON and 500 ppm. SEE CHAPTER 12.2.7

12.2.1 Menu→Setup→Analysis→Fuel

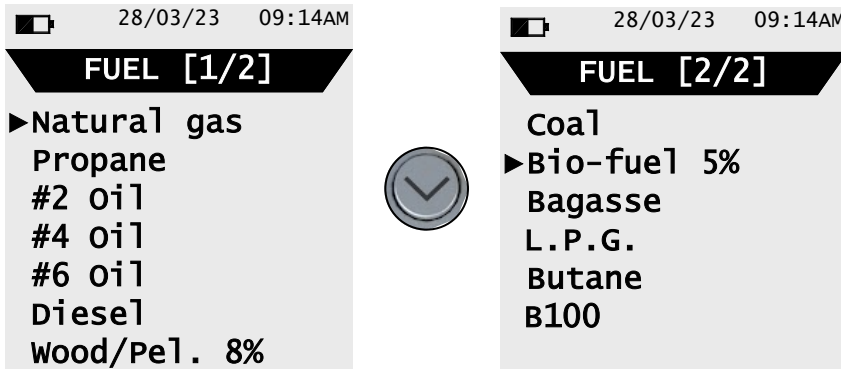

KEY	FUNCTION
	Returns to the previous screen.
	Scrolls through the pages.
	Confirms the choice of fuel to be used during the analysis.

Example:

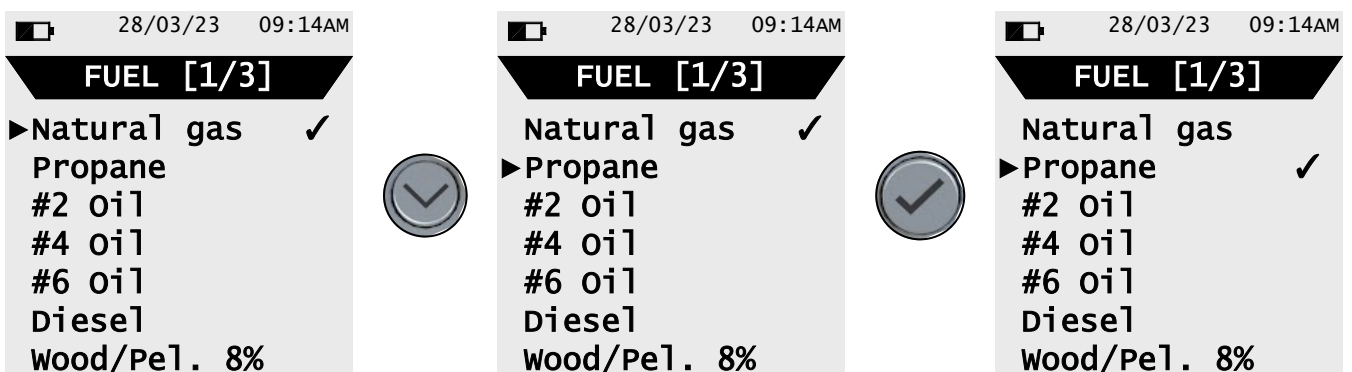

12.2.2 Menu → Setup → Analysis → Condensation

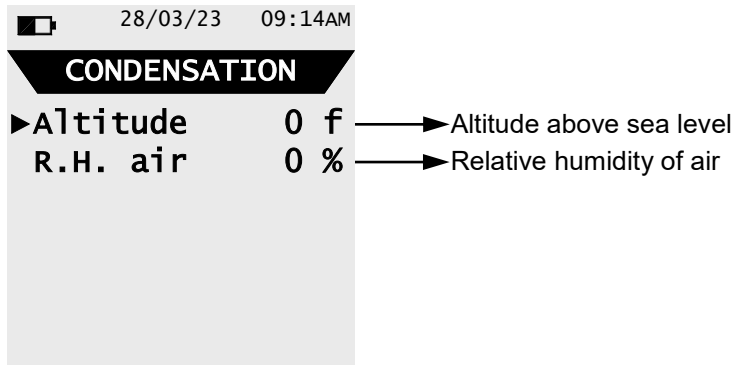

KEY	FUNCTION
	When pressed in modify mode cancels the selection made, otherwise returns to the previous screen.
	The arrows select each line displayed. In modify mode, it scrolls through the suggested values.
	Enters the modify mode for the selected parameter, then confirms the modification.

Example:

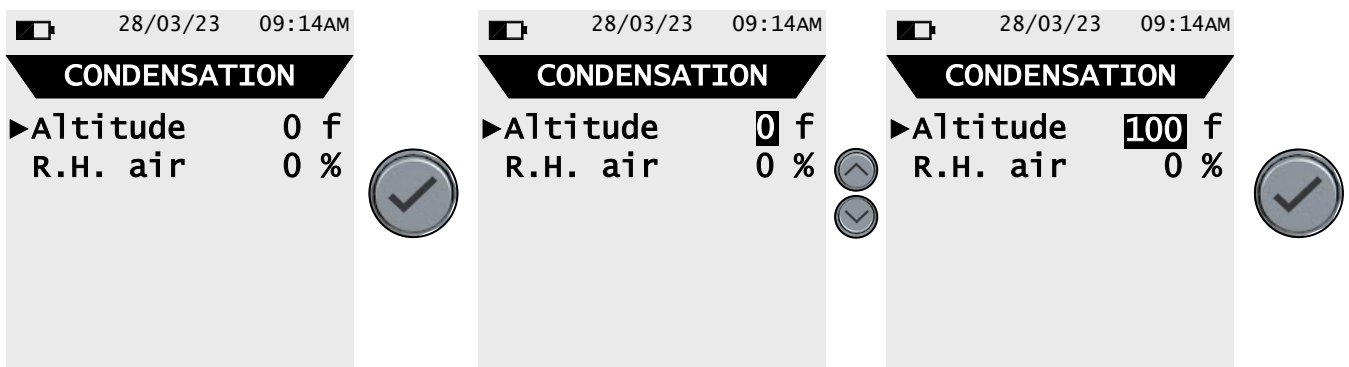

12.2.3 Menu→Setup→Analysis→O2 Reference

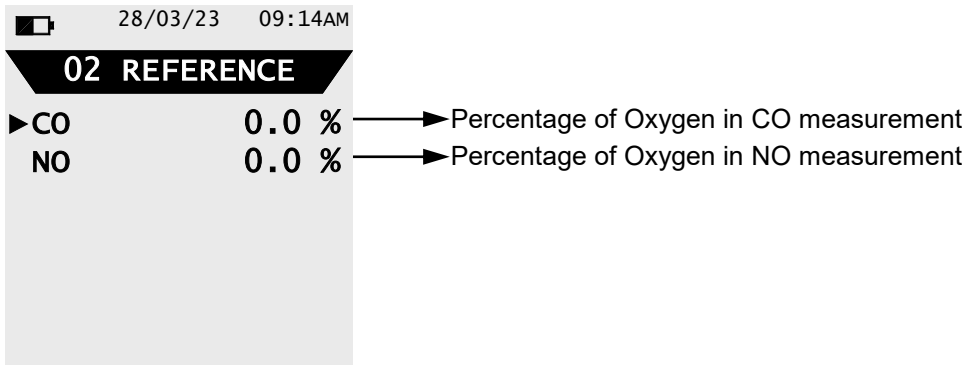

KEY	FUNCTION
	When pressed in modify mode cancels the selection made, otherwise returns to the previous screen.
 	The arrows select each line displayed. In modify mode, it scrolls through the suggested values.
	Enters the modify mode for the selected parameter, then confirms the modification.

Example:

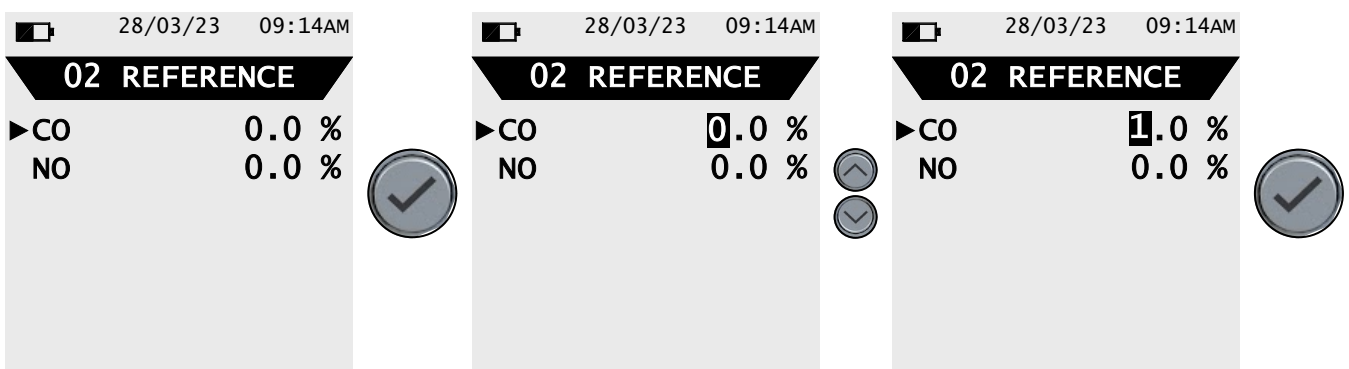

12.2.4 Menu → Setup → Analysis → Measure units

28/03/23 09:14AM

MEASURE UNITS

- ▶ CO ppm → Measurement unit can be set as: ppm - mg/m³ - mg/kWh - g/GJ - g/m³ ng/J - g/kWh - %
- Pressure hPa → Measurement unit can be set as: ppm - mg/m³ - mg/kWh - g/GJ - g/m³ ng/J - g/kWh - %
- Draft mmH2O → Measurement unit can be set as: hPa - Pa - mbar - mmH2O - mmHg - inH2O - psi
- Temperature oC → Measurement unit can be set as: °C - °F
- Altitude ft → Measurement unit can be set as: m - ft

KEY	FUNCTION
	When pressed in modify mode cancels the selection made, otherwise returns to the previous screen.
	The arrows select each line displayed. In modify mode, it scrolls through the suggested values.
	Enters the modify mode for the selected parameter, then confirms the modification.

Example:

28/03/23 09:14AM

MEASURE UNITS

- ▶ CO ppm
- Pressure hPa
- Draft mmH2O
- Temperature oC
- Altitude ft

28/03/23 09:14AM

MEASURE UNITS

- ▶ CO ppm
- Pressure hPa
- Draft mmH2O
- Temperature oC
- Altitude ft

28/03/23 09:14AM

MEASURE UNITS

- ▶ CO mg/m³
- Pressure hPa
- Draft mmH2O
- Temperature oC
- Altitude ft

12.2.5 Menu→Setup→Analysis→Autozero

28/03/23 09:14AM

AUTOZERO

▶Autozero 30 s → Duration of autozero (outdoor air sample), expressed in seconds.

Purging 0 s → Duration of the cleaning cycle, expressed in seconds.

KEY	FUNCTION
	When pressed in modify mode cancels the selection made, otherwise returns to the previous screen.
	When in modify mode, sets the desired value.
	Enters modify mode of the selected element and then confirms the change.

Example:

28/03/23 09:14AM

AUTOZERO

▶Autozero 60 s

Purging 0 s

28/03/23 09:14AM

AUTOZERO

▶Autozero 060 s

Purging 0 s

28/03/23 09:14AM

AUTOZERO

▶Autozero 065 s

Purging 0 s

12.2.6 Menu→Setup→Analysis→Air temp

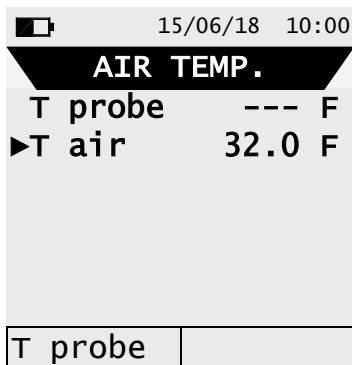

KEY	FUNCTION
	Enters modify mode of the selected element and then confirms the change.
	When in modify mode, sets the desired value.
	When pressed in modify mode cancels the selection made, otherwise returns to the previous screen.

INTERACTIVE OPERATION	DESCRIPTION
T probe	Acquires the detected temperature by the Tc-K probe connected to the instrument and uses it as primary air temperature.

Example with probe connected to the instrument:

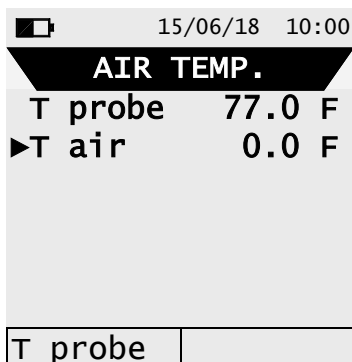

T probe

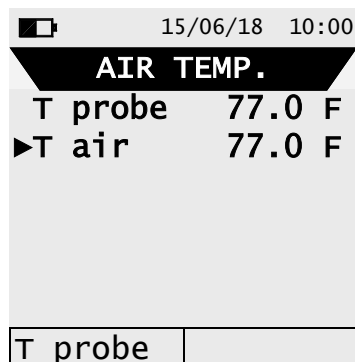

12.2.7 Menu→Setup→Analysis→CO protection

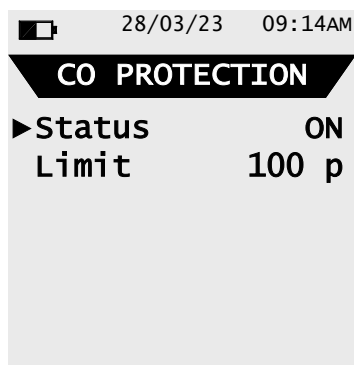

KEY	FUNCTION
	Enters modify mode of the selected element and then confirms the change.
	When in modify mode, sets the desired value.
	When pressed in modify mode cancels the selection made, otherwise returns to the previous screen.

Example:

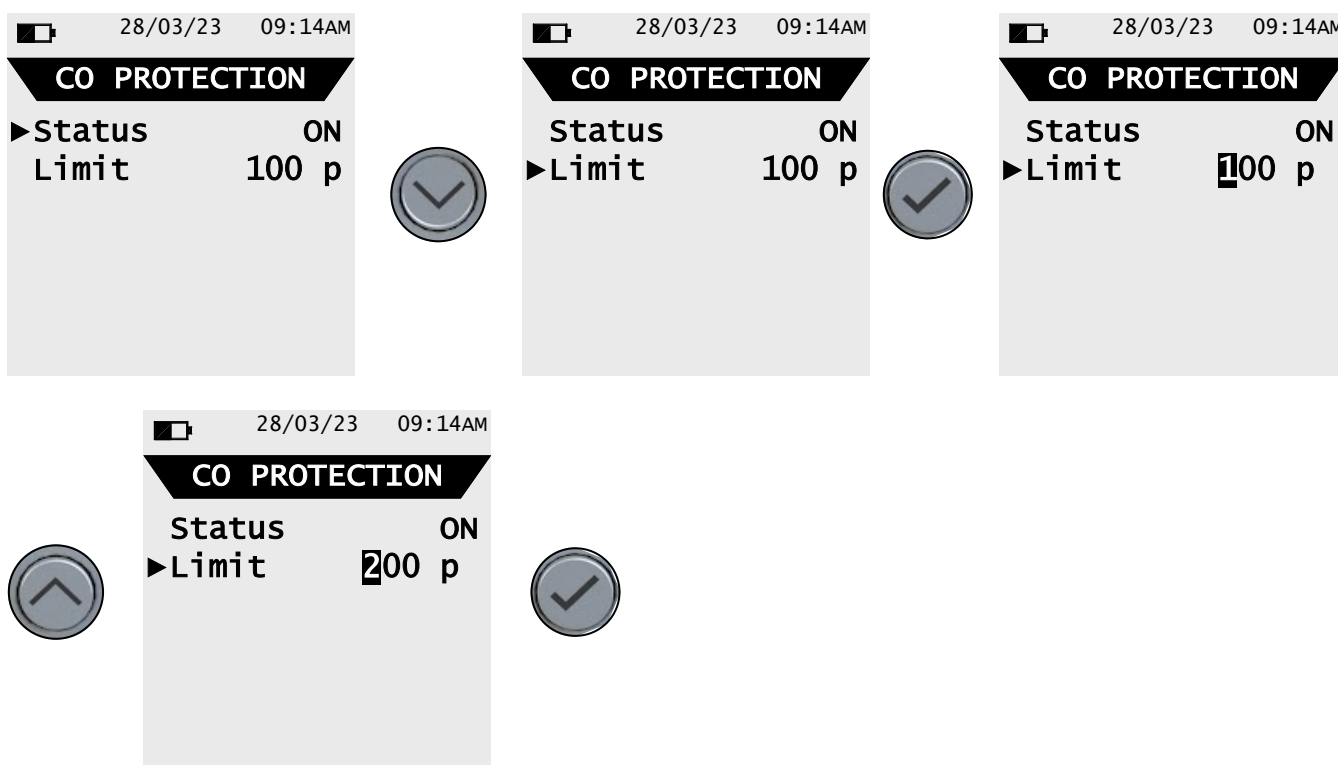

Example of CO Protection operation:

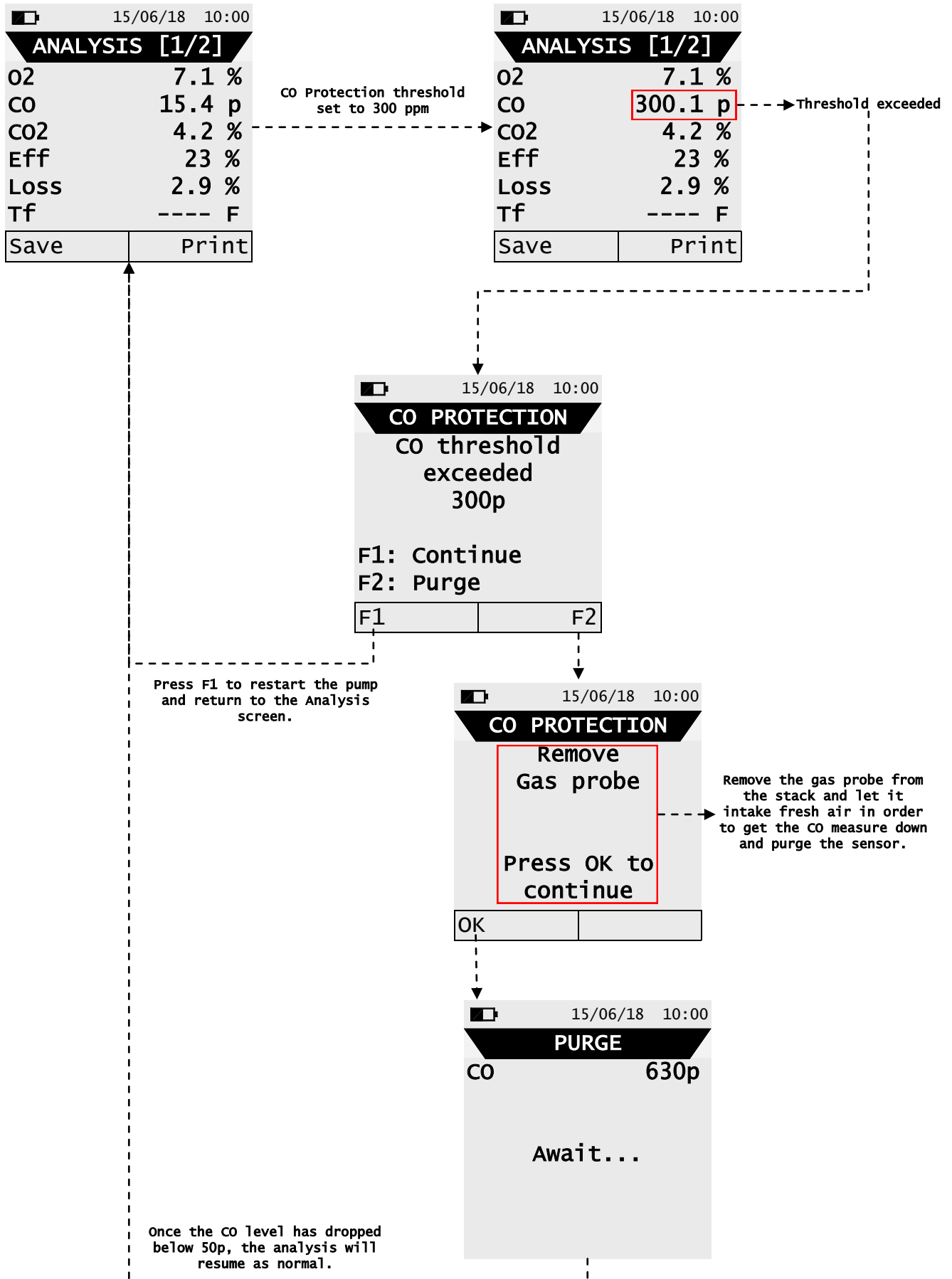

12.3 Menu→Setup→Instrument



KEY	FUNCTION
	Returns to the previous screen.
	Selects the available parameters.
	Enters in the selected parameter.

SUB MENU	FUNCTION
Display	The user can increase or decrease the brightness and the contrast of the display. SEE CHAPTER 12.3.1.
clock	This allows the current time and date to be set. The user can select the date and hour format either in EU (European) or USA (American) mode. SEE CHAPTER 12.3.2.
Bluetooth	The user can turn on and off the Bluetooth® communication of the instrument and view relevant information. When the Bluetooth is switched on, you can pair the app or the printer with the instrument. Using the app, you can view the current analysis data; by connecting the BT printer you can print on the paired external printer. SEE CHAPTER 12.3.3

12.3.1 Menu→Setup→Instrument→Display

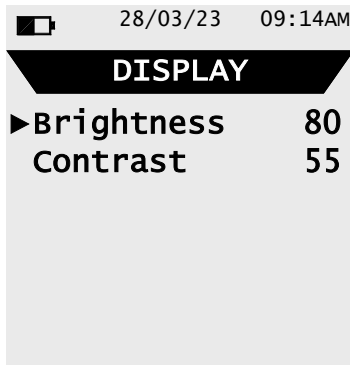

KEY	FUNCTION
	When pressed in modify mode cancels the selection made, otherwise returns to the previous screen.
	The arrows select each line displayed. In modify mode, it scrolls through the suggested values.
	Enters the modify mode for the selected parameter, then confirms the modification.

Example:

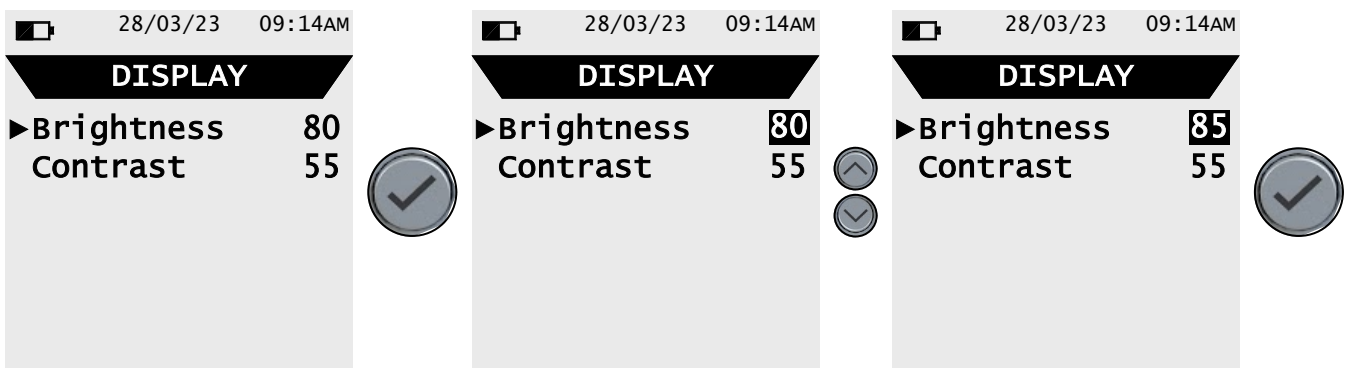

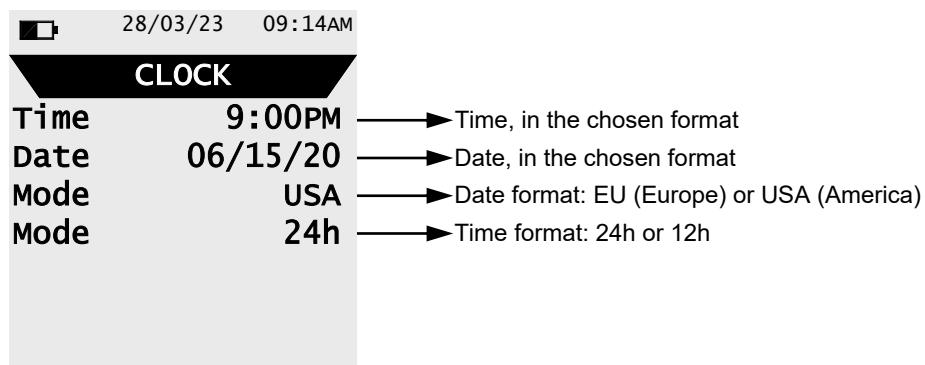

12.3.2 Menu→Setup→Instrument→Clock





The screenshot shows the 'CLOCK' menu with the following settings and their functions:

- Time** 9:00PM → Time, in the chosen format
- Date** 06/15/20 → Date, in the chosen format
- Mode** USA → Date format: EU (Europe) or USA (America)
- Mode** 24h → Time format: 24h or 12h

KEY	FUNCTION
	When pressed in modify mode cancels the selection made, otherwise returns to the previous screen.
	Selects line. In modify mode sets the value or the desired mode.
	Enters the modify mode for the selected parameter, then confirms the modification.

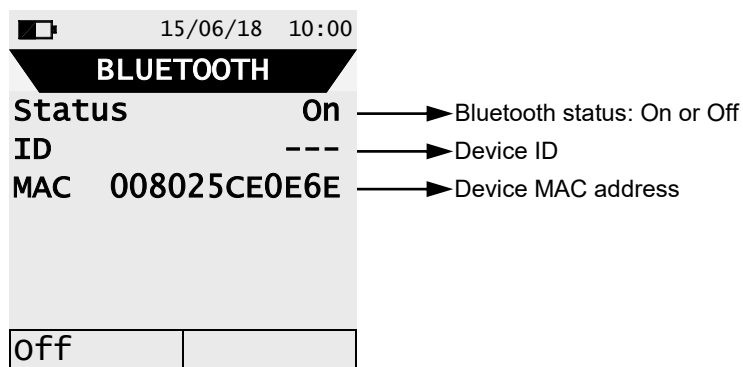
12.3.3 Menu → Setup → Instrument → Bluetooth®



KEY	FUNCTION
	Activate the context keys shown on the display.
	Goes back to the previous screen.

INTERACTIVE OPERATIONS	DESCRIPTION
Off	Turns off Bluetooth®.
On	Turns on Bluetooth®.

12.4 Menu → Setup → Alarm

28/03/23 09:14AM

ALARM

▶ Measure	O2	→	Observed parameter: CO - NO - O2
Mode	Min	→	Kind of set alarm: Max / Min / Off
Limit	18.0 %	→	Concentration threshold of the observed gas.

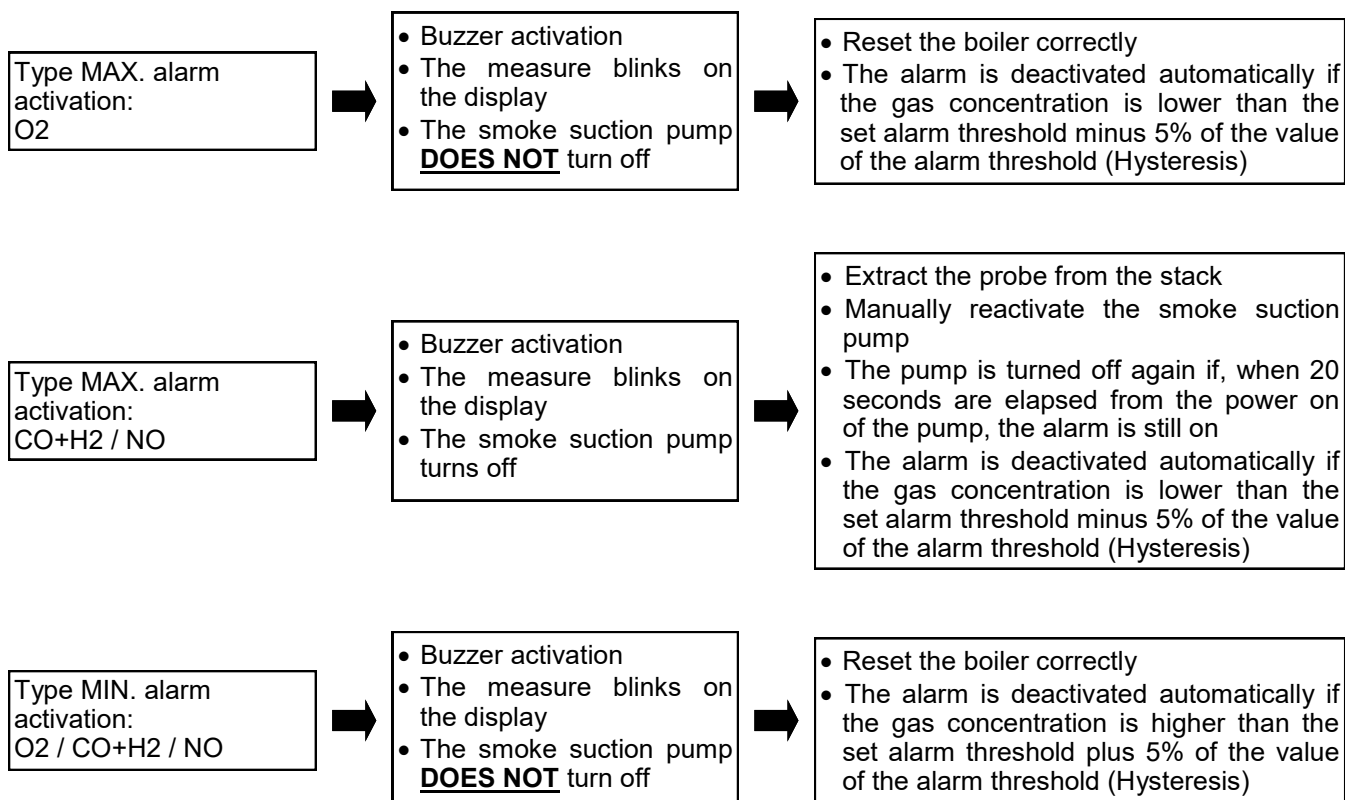

KEY	FUNCTION
	Enters the modify mode for the selected parameter, then confirms the modification.
	Selects line. In modify mode, sets the value or the desired mode.
	When pressed in modify mode cancels the selection made, otherwise returns to the previous screen.

Alarm activation flow chart and suggested corrective actions

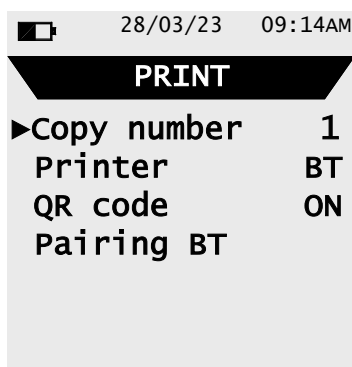

12.5. Menu→Setup→Print



KEY	FUNCTION
	Enters modify mode of the selected data and then confirms it.
	Selects the available parameters. In modify mode, scrolls the available values.
	When pressed in modify mode cancels the selection made, otherwise returns to the previous screen.

PARAMETER	DESCRIPTION
Copy number	Sets the number of ticket copies to be printed. This is a valid setting only if a printer has been selected.
Printer	Select the type of printer with which the ticket is printed: BT: Bluetooth® - at the first start up it is necessary to perform the pairing procedure described below. OFF: none - the printer is turned off.
QR code	QR code generation ON: pushing the button related to the interactive function "Print" the instrument generates a QR code, which can be read with the " FLUE-Mate app " to download the data acquired of the performed combustion analysis and the additional measures. OFF: the QR code will not be shown.
Pairing BT	Select to pair the Bluetooth® printer.

12.5.1 Menu→Setup→Print→Pairing

1. When the Bluetooth printer is set, proceed with the following procedure:

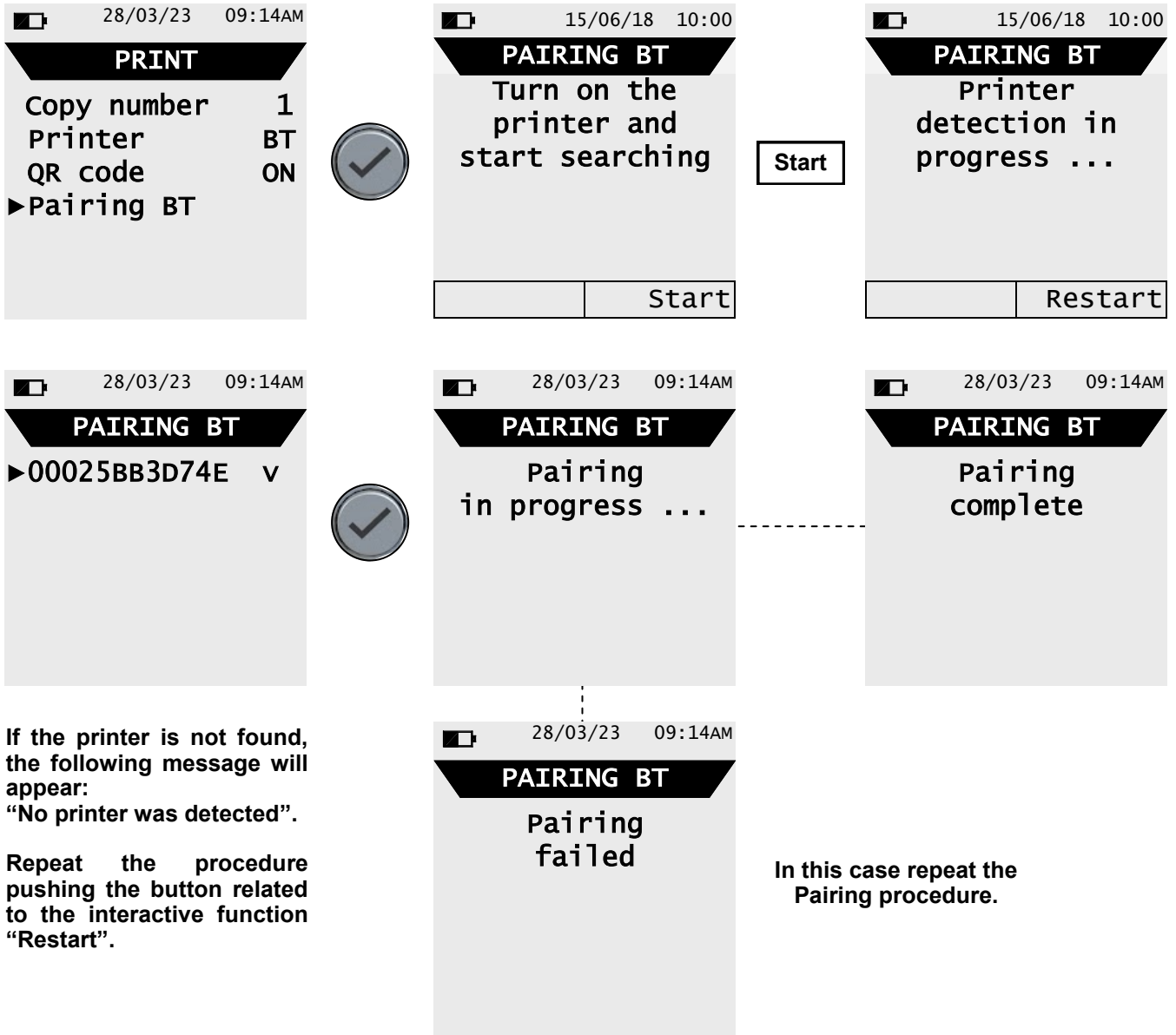



If the printer is not found, the following message will appear:
"No printer was detected".

Repeat the procedure pushing the button related to the interactive function "Restart".

In this case repeat the Pairing procedure.

12.6 Menu→Setup→Language



KEY	FUNCTION
	Returns to the previous screen.
	Scrolls through the available languages.
	Sets the selected language.

Example:



12.7 Menu→Setup→Reset

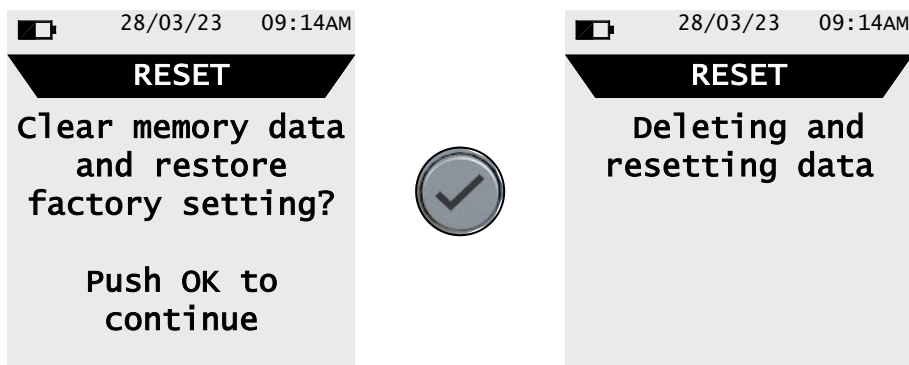

KEY	FUNCTION
	Exits the current screen without resetting.
	Starts the factory data reset phase.

13.1 Menu→Service



KEY	FUNCTION
	Returns to the previous screen.
	Selects the available parameters.
	Enters in the selected parameter.

SUB MENU	DESCRIPTION
Sensors	Displays information on the state and calibration of the electrochemical sensors. Displays the ID data of the sensor: Code Serial number Manufacturing and calibration date. Measured currents (to perform a quick diagnosis in case of malfunction). SEE CHAPTER 13.1.1.
Gas probe	Tests the tightness of the gas probe pneumatic path. SEE CHAPTER 13.1.2.
Hardware	If a malfunction happens, collect the data from this menu before contacting INFICON. SEE CHAPTER 13.1.3.

13.1.1 Menu → Service → Sensors

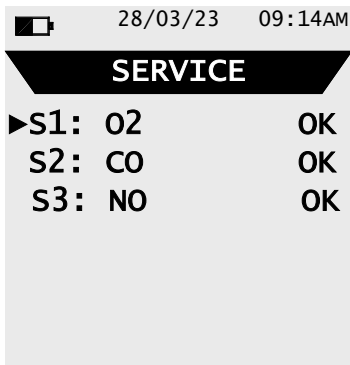

Messages on the state and calibration of the electrochemical sensors:

Ok	No problem detected
absent	The sensor was not detected
err data	Memory data error of the sensor
unknown	It is necessary to update the FW of the device
err pos	The sensor has been installed in the wrong position
err cal	Calibration error (sensor not calibrated)
err curr	Currents outside the range
err cfg	Do not use this sensor as it has not been accepted on the screen "types of sensors".

KEY	DESCRIPTION
	Returns to the previous screen.
	Selects the available parameters.
	Shows the details about the selected sensor.

Example:

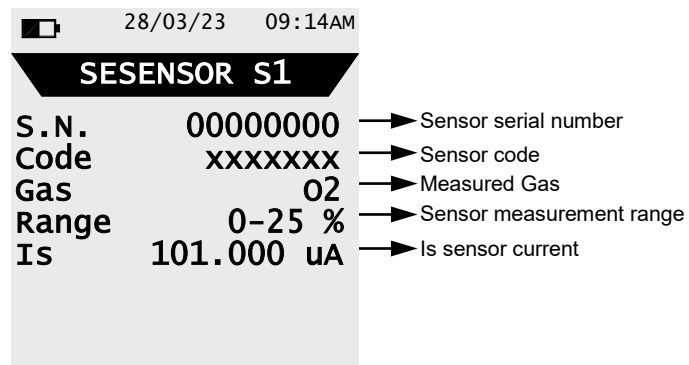
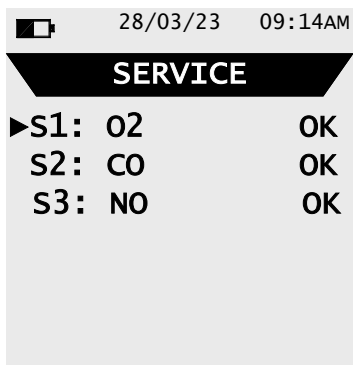

13.1.2 Menu → Service → Gas probe

28/03/23 09:14AM

GAS PROBE

Close the flue gas probe

Press OK to start

Connect the flue gas sampling probe and filter unit assembly to the instrument;
Fully insert the black rubber cap on the gas probe tip, as shown in the following picture:

Provided black rubber cap

KEY	FUNCTION
	Returns to the previous screen.
	Starts the test to check the tightness of the gas sampling probe.

Tightness test of the probe.

28/03/23 09:14AM

GAS PROBE

Close the flue gas probe

Press OK to start

28/03/23 09:14AM

GAS PROBE

Calibration

→

28/03/23 09:14AM

GAS PROBE

Calibration
Probe test

→

28/03/23 09:14AM

GAS PROBE

Calibration
Probe Test

Result: tight

Results:

- tight:** The system is OK
- leak:** Make sure that the probe is connected to the input P- or P+, check the seals of the pneumatic connections and/or the seal of the condensation trap and check that the test cap is correctly inserted on the tip of the probe. **WARNING: a damaged probe tip may impair the test.**
- Error:** It is not possible to perform the test because the sensor is not calibrated.



13.1.3 Menu→Diagnostic→Hardware



KEY	FUNCTION
	Returns to the previous screen.
	Selects the available parameters.
	Enters in the selected parameter.

INTERACTIVE OPERATIONS	DESCRIPTION
mV	Shows the values in mV.
Bit	Shows the values in Bit.

Note: the memory and calibration parameters are not accessible if their condition is OK.

Visualization example:

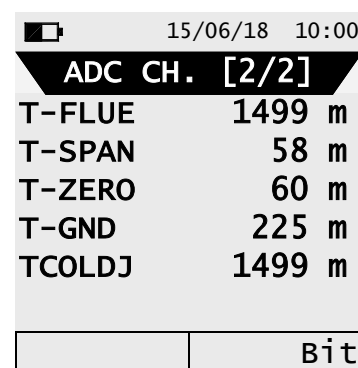
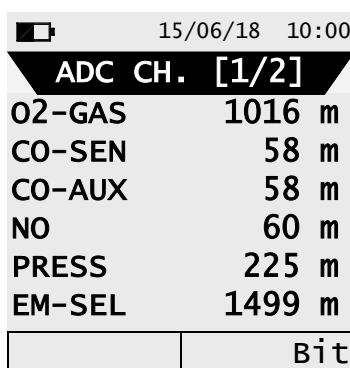
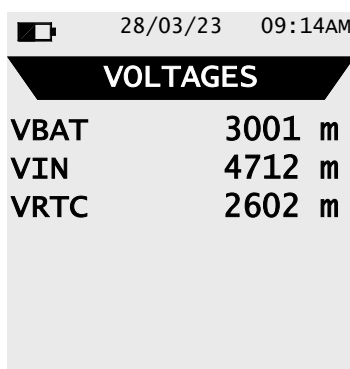

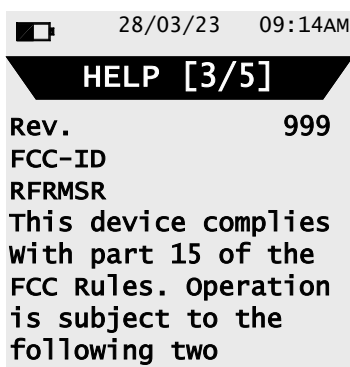
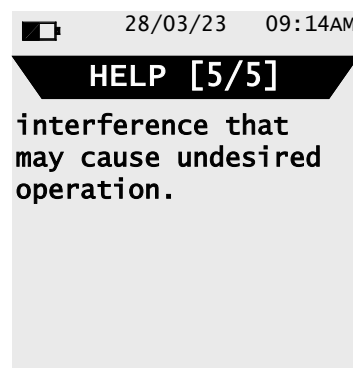
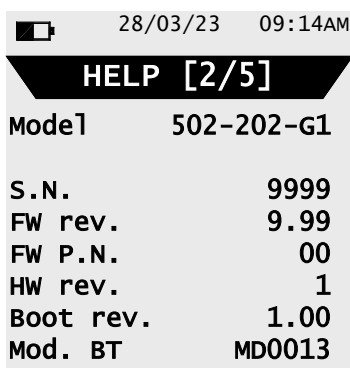
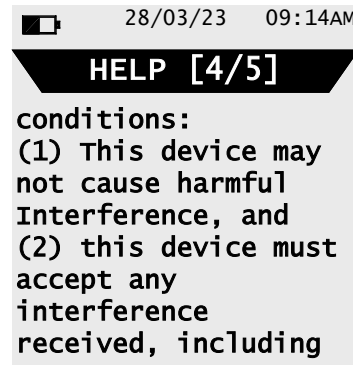

KEY	FUNCTION
	Returns to the previous screen.
	Toggle view between next or previous screen.

15.1 Sensors arrangement

SENSORS ARRANGEMENT INSIDE THE SENSORS COMPARTMENT

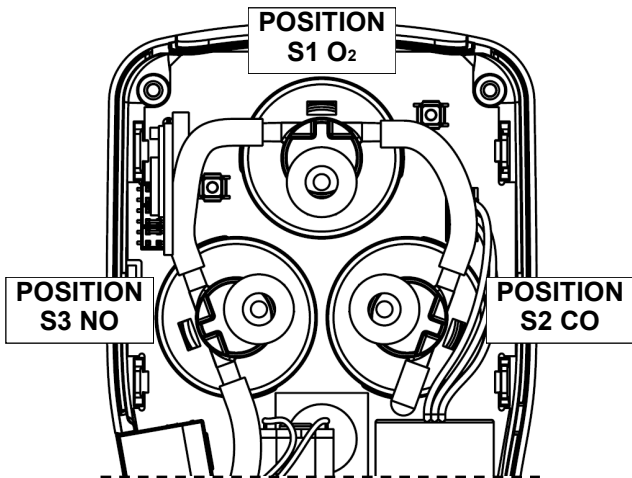

GRAPHICAL DISPLAY OF ARRANGEMENT

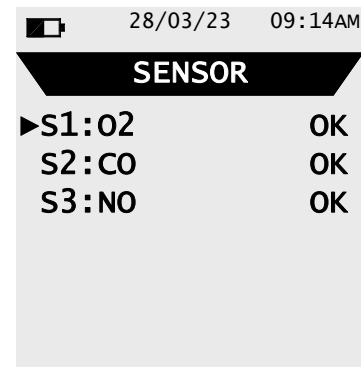

15.2 Sensor types and relevant positioning

CODE	POSITION	S1	S2	S3
O ₂ Sensor PN. 502-601-P1		✓		
CO Sensor with NOx filter 0-4000ppm			✓	
NO Sensor				✓

15.3 Gas sensors life

The gas sensors used in this instrument are electrochemical. When the relative gas is detected, a chemical reaction takes place inside them that generates an electrical current. The electrical current acquired by the instrument is then converted into the corresponding gas concentration. Sensor life is strongly related to the consumption of the reagents within. Sensor characteristics diminish as the reagents are consumed and when these have been used up completely the sensor must be replaced. The sensors must be recalibrated on a regular basis to assure measuring accuracy. Recalibration can only be performed by a qualified INFICON service center. Table 15.4 illustrates the characteristics inherent to each sensor.

15.4 Gas sensors life table

CODE	MEASURED GAS	AVERAGE LIFE	RECALIBRATION
O ₂ Sensor PN: 502-601-P1	O ₂ Oxygen	24 months	not necessary
CO Sensor with NOx filter + H2 immunity 0-4000ppm	CO Carbon Monoxide	24 months	Yearly
NO Sensor	NO Nitric Oxide	>36 months	Yearly

16.1 Routine maintenance

This instrument was designed and manufactured using top-quality components. Proper and systematic maintenance will prevent the onset of malfunctions and will increase instrument life altogether.

The following basic requisites are to be respected:

- When the analysis is over extract the sample probe from the stack and let the analyzer draw fresh air for a few minutes, or at least until the displayed parameters return to their original values:
O₂: >20.0%
Toxic gases: <20ppm
- Clean the filter unit when necessary, replacing the particulate filter and applying a jet of air to the sample probe hose to eliminate any condensate that may have formed.

Do not clean the instrument with abrasive cleaners, thinners or other similar detergents.

16.2 Preventive maintenance

To maintain peak performance and safety, it is recommended to send your FLUE-Mate in for maintenance and calibration once per year.



Contact **INFICON** to arrange for service.

17.0 FIRMWARE UPDATE

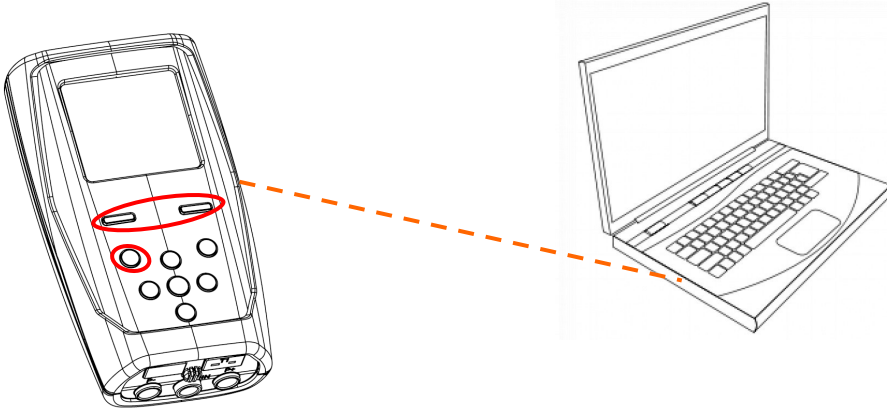

The manufacturer periodically releases firmware updates of the instrument in order to correct unavoidable mistakes or improve the instrument performance or add new functions. This update can be performed by the user by following the simple instructions below.

Instructions to update the combustion analyzer with a new firmware:





1. Navigate to www.inficon.com and download the firmware file available in the FLUE-Mate downloads section. This file is in a compressed version .zip.
2. Unzip the file (extension .srec).
3. Plug in the analyzer to the PC via the USB cable.
4. Hold down the three buttons circled in red above on the analyzer for at least 10 seconds:

5. The display turns off.
6. Release only the power  button.
7. The analyzer will be recognized by the operating system as a portable device drive: the display starts blinking.
8. Release the remaining two buttons.
9. Copy the firmware file (extension .srec) to the directory of the analyzer: the display continues to blink faster.
10. Wait till the end of the file copy operation.
11. The file copy directory will be closed and the analyzer will restart.
12. The analyzer is now updated, it can be powered off and unplugged from the PC.

18.1 Troubleshooting guide

SYMPTOM	PROBABLE CAUSES AND REMEDIES
<p>The instrument does not work at all. Pushing the  button the instrument does not turn on.</p>	<ul style="list-style-type: none"> a. Press the  for at least 2 seconds. b. The battery is low; connect the battery charger to the instrument. c. The battery pack is not connected to the instrument. Access the internal parts of the instrument and verify that the connector of the battery pack is inserted in the proper connector (SEE CHAPTER 16.4). d. The instrument is faulty: contact a service center.
<p>The battery symbol is empty on the inside and blinking.</p>	<p>The batteries are low. The instrument will remain on for a couple of minutes after which it will switch off; connect the battery charger.</p>
<p>The instrument battery life is lower than what stated in the “Technical features” chapter.</p>	<ul style="list-style-type: none"> a. The battery capacity is limited at a low temperature. To obtain a greater life it is advised to keep the instrument in higher temperatures. b. Perform a 100% complete charge cycle connecting the instrument to the plug for at least 6 hrs. c. The battery pack is old. Aging can cause the batteries to reduce their capacity. If the life has become unacceptable send the instrument to a service center. d. Verify the measured voltage values in “Menu→Setup→Hardware→Voltages”: <ul style="list-style-type: none"> - If VBAT<3000mV: the battery needs to be changed. - If VIN <4700mV: the output voltage of the battery charger is not sufficient to recharge the instrument battery. In this case verify the connections and the plate data of the battery charger in use: 5Vdc 2A. d. If the problem keeps on happening contact the SERVICE CENTER.
<p>Date and time are not memorized.</p>	<ul style="list-style-type: none"> a. Verify the voltage value VRTC showed in “Menu→Setup→Hardware→Voltages”: If <2600mV contact the SERVICE CENTER. b. The battery is completely drained (VBAT<2500mV)
<p>After the autozero, the sensor diagnostic screen appears, which indicates an error in one or more cells.</p>	<ul style="list-style-type: none"> a. The autozero has been performed while the combustion gas sample was still being taken. b. The O₂ sensor is broken, incorrectly connected or not connected at all. c. The waited settling time of the sensor was not enough or the instrument has been left with a low battery charge for a long time.
<p>In the Pressure / Draft screen there is an error of the pressure sensor.</p>	<p>There is a calibration problem. Contact the SERVICE CENTER.</p>
<p>In the analysis screen there is an error in the smoke temperature measurement (Tf).</p>	<ul style="list-style-type: none"> a. Thermocouple not connected; connect the thermocouple to the analyzer. b. The sensor has been exposed to temperature higher or lower than its functioning. c. The thermocouple is faulty. Contact the service center.

Troubleshooting guide

SYMPTOM	PROBABLE CAUSES AND REMEDIES
The following symbol "----" appears on the analysis screen.	The instrument is not able to calculate a numerical value based on the flue gas analysis conducted. The "----" are replaced by numbers when the analyzer detects valid combustion data.
"Max. Lim." or "Min. Lim" appears on the analysis screen.	The relative sensor is detecting a value that is beyond the analyzer measuring range. "Max. Lim" or "Min. Lim." are replaced by numbers when the instrument reveals values that are within the measuring range.
The sample pump sounds as though it is running slowly, tends to stop or does not even start.	<ul style="list-style-type: none"> a. Sample flow is obstructed. Check that the water filter is clean and that it is not completely soaked. Also check that the hose connected to the probe is not crushed. b. Sample intake flow is obstructed. Check that the particulate filter is clean. c. Pump is disabled. The key combination   has been pressed. To re-enable the pump, switch off the instrument and then switch it on again.
The back lighting of the display does not turn on.	The instrument is faulty. Contact the SERVICE CENTER.
The values shown in the analysis screen are not reliable.	<ul style="list-style-type: none"> a. Sensor(s) is/are faulty. Check that the sensors are installed correctly by accessing the sensor diagnostics menu. b. The sample probe connection presents a leak. Check all joints and the conditions of the hose. c. The instrument is faulty: Contact the SERVICE CENTER.

19.1 Spare parts

CODE	DESCRIPTION
502-603-P1	FLUE-Mate Filters – 5 pieces
502-608-P1	FLUE-Mate Probe positioning cone
502-601-P1	FLUE-Mate O ₂ pre-calibrated sensor
502-609-P1	FLUE-Mate Replacement o-ring – 5 pieces
502-602-P1	FLUE-Mate International wall charger (Includes US and international plugs and USB cable)
502-612-P1	FLUE-Mate Replacement battery
502-604-P1	FLUE-Mate Replacement paper – 5 pieces
502-606-P1	FLUE-Mate Water trap assembly w/ filter included

19.2 Accessories

CODE	DESCRIPTION
502-607-P1	FLUE-Mate Hard ABS carrying case
502-611-P1	FLUE-Mate Pressure manometer hose
502-610-P1	FLUE-Mate 12 in. (300 mm) flue gas probe with 5 ft. (1.5 m) cable up to 752 °F (400 °C)
502-600-P1	FLUE-Mate Bluetooth® printer
502-605-P1	FLUE-Mate USB charging cable

19.3 Service Centers

Before sending your instrument to an **INFICON** service center, contact **INFICON** to arrange for service.

Data Management with "FLUE-Mate" APP

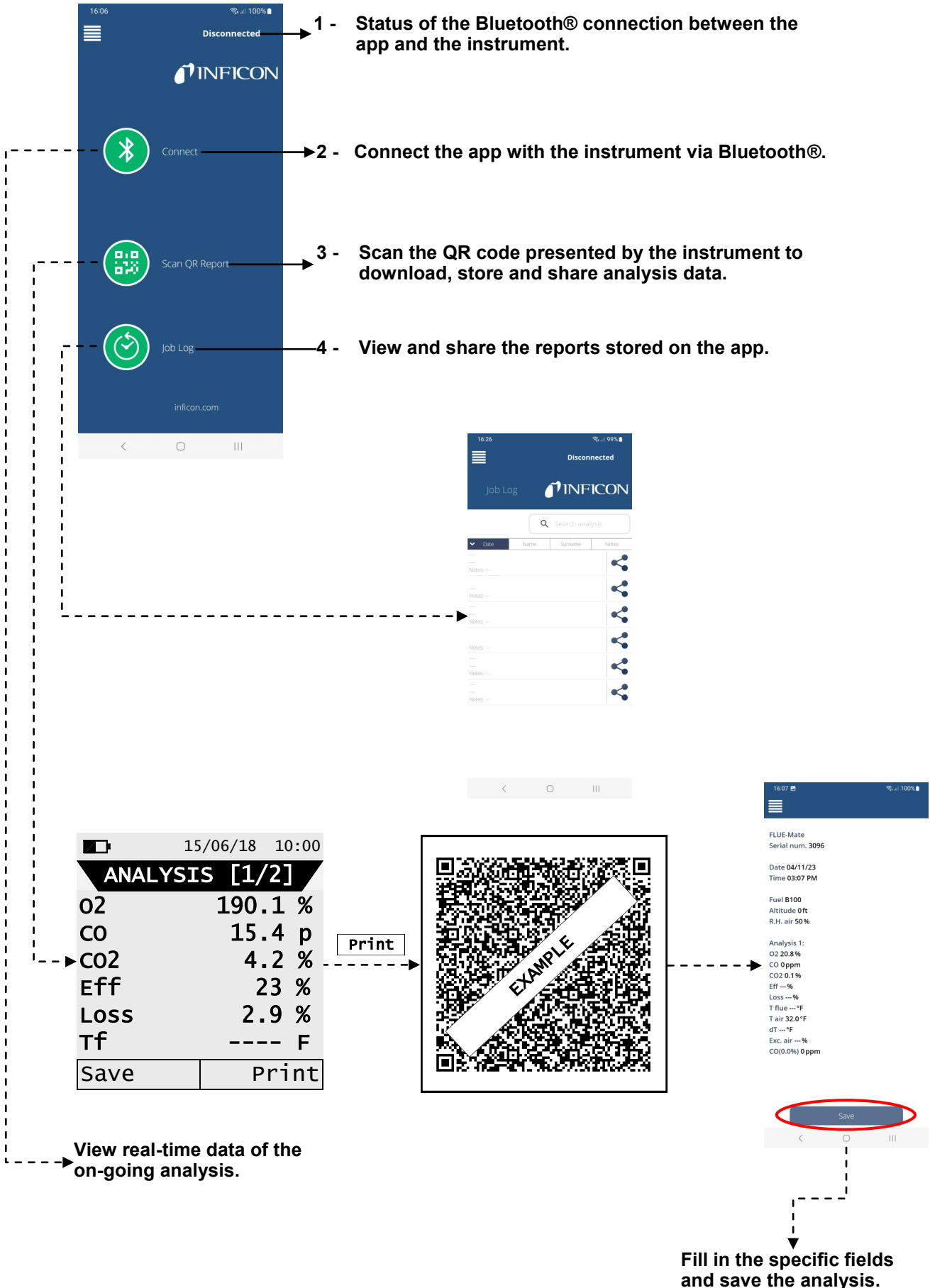

Example of the exported csv file and imported into a spreadsheet:

FLUE-Mate		
Serial num.	1100	
Date	22/12/2023	
Time	12:00	
Fuel	Natural Gas	
Altitude	0.000000m	
RH air	50%	
O2	15.7%	
CO	23ppm	
CO2	2.9%	
T flue	100.6°C	
T air	27.0°C	
η_s	90.0%	
NO	0.000mV	
CO-SEN	258.270mV	
O2	1.131.867mV	
I sen	0.000uA	
I sen	0.000uA	
I sen	100.346uA	
T az	22.5°C	
ΔT	73.6°C	
Qs	10.0%	
λ_n	4.01	
Exc. air	4.01	
η_c	0.0%	
η_t	90.0%	
Qs (PCS)	10.0%	
Qt (PCS)	10.0%	
η_s (PCS)	90.0%	
η_c (PCS)	0.0%	
η_t (PCS)	90.0%	
NO	0ppm	
NOx	0ppm	
CO (0.0%)	0ppm	
NO (0.0%)	0ppm	
NOx (0.0%)	0ppm	
Draft	4.5Pa	

Measures list:

MEASURE	DEFINITION
λ, n (l,n)	Air index (defined as λ , sometimes also indicated as n).
e (Exc. Air)	Excess Air. Expressed as a percentage according to the formula in the appendix D, is the ratio between the volume of air actually entering the combustion chamber and the one theoretically needed.
ΔT (dT)	Differential temperature: The difference between the smoke temperature and the air combustion temperature.
Qs (LHV)	Stack losses in relation to the Lower Heating Value: The percentage of dissipated heat through the stack referred to the lower heating value (LHV)
η_s (Es) (LHV)	Sensible efficiency in relation to the Lower Heating Value: The burner efficiency calculated as the ratio between conventional heating power and the burner heating power. Among the combustion losses, only the sensible heat lost with flue gasses is taken into account, thus neglecting the radiation losses and incomplete combustion losses. This value is referred to the Lower Heating Value (LHV) of the fuel and cannot exceed 100%. The sensible efficiency value is to be compared against minimum efficiency stated for the heating system performances.
η_c (Ec) (LHV)	Condensation efficiency in relation to the Lower Heating Value: Efficiency derived from the condensation of water vapor contained in flue gases. It is referred to the LHV.
η_t (Eff) (LHV) $\eta_t = \eta_s + \eta_c$	Total efficiency in relation to the Lower Heating Value: Total efficiency. It is the sum of sensible efficiency and condensation efficiency. It is referred to LHV (Lower Heating Value) and can exceed 100%.
NOx	Measure of nitrogen oxide quantity; the measurement unit can be set in: Menu→Setup→Analysis→Measure units.
NOx (ref. O2)	Measure of nitrogen oxide quantity referring to O2; the measurement unit can be set in: Menu→Setup→Analysis→Measure units.
PI	Poison Index (CO/CO2 ratio): It is defined as the ratio between CO and CO2. Useful to determine whether the system needs maintenance.
CO	CO quantity measurement. Measurement units: ppm - mg/m ³ - mg/kWh - ng/J - g/GJ - g/m ³ - mg/kWh - %
CO (REF)	CO quantity measurement with O2 reference. Measurement units: ppm - mg/m ³ - mg/kWh - ng/J - g/GJ - g/m ³ - mg/kWh - %

Measurement units matching → abbreviations

ppm	p
mg/m ³	g
mg/Kwh	w
g/GJ	J
ng/J	J
g/m ³	G
g/Kwh	W
hPa	h
Pa	P
mbar	b
mmH ₂ O	H
mmHg	g
inH ₂ O	i
psi	p
°C	C
°F	F
m	m
ft	ft

Coefficients of the fuels and Formulas

The following chart lists the coefficients of the memorized fuels used for calculating losses and efficiencies. Details of the coefficients of the fuels:

Coefficients for calculating combustion efficiency								
Fuel	A1 USA	B	CO ₂ t (%)	PCI (kJ/kg)	PCS (kJ/kg)	M air (kg/kg)	M H ₂ O (kg/kg)	V dry gas (m ³ /kg)
Natural Gas	0.0280	0.0090	11.70	50050	55550	17.17	2.250	11.94
Propane	0.0277	0.0073	13.70	45950	49950	15.61	1.638	11.11
#2 Oil	0.0305	0.0066	15.70	42900	45700	14.30	1.136	10.34
#4 Oil	0.0306	0.0066	15.80	41100	43500	13.80	0.973	10.06
#6 Oil	0.0346	0.0048	16.00	39800	42197	13.61	0.981	9.97
Diesel	0.0305	0.0066	15.70	42900	45700	14.30	1.136	10.34
Wood/Pellets 8%	0.0354	0.0071	19.01	18150	19750	6.02	0.660	4.58
Bagasse	0.0395	0.0219	20.45	6950	8834	2.50	0.779	1.93
Coal	0.0320	0.0000	18.60	31400	32300	10.70	0.370	8.14
Biogas	0.0353	0.0091	17.33	17800	19800	6.08	0.830	4.55
Bio-Fuel 5%	0.0305	0.0066	15.70	42600	45400	14.22	1.133	10.64
Butane	0.0277	0.0073	14.00	45360	49150	15.38	1.548	10.99
B100	0.0308	0.0053	15.77	37864	40528	12.5	1.08	12.42

- **CO₂ t:** The value of CO₂ generated by combustion in stoichiometric condition, i.e. without excess Oxygen and therefore maximum.
- **A1, B:** Also please have a look at the Siegert formulas from the European standard EN50379-1 (in the following).
A1 is the parameter in the Siegert Formula when the O₂ measurement is available.
Note: - Please also consider that in the U.S. usually the A1 parameter is the same as the 'European' A1 BUT divided by 2.

Flue gas heat losses are calculated from measured oxygen content according to the relationship:

$$q_A = (t_A - t_L) \times \left(A1 \frac{21}{21 - O_2} + B \right)$$

Flue gas heat losses are calculated from measured carbon dioxide content according to the relationship:

$$q_A = (t_A - t_L) \times \left(A1 \frac{CO_2t}{CO_2} + B \right)$$

Air index is calculated with the formula:

$\lambda = 21 / (21 - O_2)$, where O₂ is the oxygen residual concentration in the combustion smokes.

Air excess is calculated with the formula:

$$e = (\lambda - 1) * 100$$

- **CO conv:** Conversion coefficient from ppm to mg/kWh. It can be expressed as a function of the gas density (CO in this case) and the volume of the dry smoke.
- **NO conv:** Same as CO conv, but for NO.
- **NO_x conv:** Same as CO conv, but for NO_x.
- **SO₂ conv:** Same as CO conv, but for SO₂.
- **PCI:** Potere Calorifico Inferiore. Italian for LHV (Lower Heating Value).
- **PCS:** Potere Calorifico Superiore. Italian for HHV (Higher Heating Value).
- **m H₂O:** Mass of the air produced (per each kg of fuel) in the combustion in stoichiometric condition.
- **m Air:** Mass of the air needed for combustion in stoichiometric condition.
- **V g.d.:** Volume of dry smokes produced in the combustion.

Warranty and Liability-Limitation

INFICON warrants your FLUE-Mate Combustion Analyzer to be free from defects of materials or workmanship for one or two years (depending on region) from the date of purchase. INFICON does not warrant items that deteriorate under normal use, including batteries, sensors, and filters. In addition, INFICON does not warrant any instrument that has been subjected to misuse, negligence, or accident, or has been repaired or altered by anyone other than INFICON. INFICON liability is limited to instruments returned to INFICON, transportation prepaid, not later than thirty (30) days after the warranty period expires, and which INFICON judges to have malfunctioned because of defective materials or workmanship. INFICON liability is limited to, at its option, repairing or replacing the defective instrument or part. This warranty is in lieu of all other warranties, express or implied, whether of MERCHANTABILITY or of FITNESS FOR A PARTICULAR PURPOSE or otherwise. All such other warranties are expressly disclaimed. INFICON shall have no liability in excess of the price paid to INFICON for the instrument plus return transportation charges prepaid. INFICON shall have no liability for any incidental or consequential damages. All such liabilities are EXCLUDED.



Two Technology Place
East Syracuse, NY 13057-9714 USA
Phone: +1.800.344.3304
E-Mail: service.tools@inficon.com
www.inficonservicetools.com

Bonner Strasse 498
D-50968 Cologne, Germany
Phone: +49 221 56788-660
E-Mail: servicetools.europe@inficon.com
www.inficonservicetools-europe.com

Section A, Building 6
108 Shuya Road, Shanghai, China
Phone: +86-21-62093094
Email: reach.china@inficon.com

Korea
Phone: +82-31-206-2890
Email: reach.korea@inficon.com

Japan
Phone: +81-44-322-8901
Email: reach.japan@inficon.com

Singapore
Phone: +65-6631-0303
Email: reach.singapore@inficon.com

Taiwan
Phone: +886-3-5525828
Email: reach.taiwan@inficon.com

Due to our continuing program of product improvements, specifications are subject to change without notice.
All trademarks are the property of their respective owners.
einl01a1 -a ©2023 INFICON