



Translation of the original operating instructions

Contura[®] S400

Leak detector

Catalog No.
570-000, 570-002

From software version
1.52 (Operating unit)



INFICON GmbH

Bonner Strasse 498

50968 Cologne, Germany

Table of Contents

1 About this manual	7
1.1 Warnings	7
1.2 Target groups	7
2 Safety	8
2.1 Intended use	8
2.2 Duties of the operator	9
2.3 Owner requirements	9
2.4 Dangers	9
3 Shipment, Transport, Storage	11
4 Description	12
4.1 Function	12
4.2 Device setup	13
4.2.1 Overall device	13
4.2.2 Markings on the device	14
4.3 Display	15
4.3.1 Assembly of the touchscreen	15
4.3.2 Result display	17
4.4 Technical data	18
4.5 Factory settings	19
5 Installation	20
5.1 Setup	20
5.2 Connecting to the power supply system	21
5.3 USB interface usage	21
5.3.1 Configure barcode scanner	21
5.4 Other interfaces	21
6 Operation	23
6.1 Switch on and login	23
6.2 Basic settings	23
6.2.1 Setting the language	23
6.2.2 Setting date, time and time zone	23
6.2.3 User profile settings	23
6.2.3.1 Overview of Rights Groups	23
6.2.3.2 Select, modify, create user profile	24

6.2.3.3	Modify Personal Settings	25
6.2.4	Switch off Automatic Login.....	26
6.2.5	Switch on Automatic Login.....	26
6.2.6	Product-specific settings	26
6.2.6.1	Determine the Measuring mode	26
6.2.6.2	Select, modify or create product (measurement settings)	28
6.2.6.3	Create product variants	29
6.2.6.4	Assigning shortcut keys to products	29
6.2.7	Changing the volume	30
6.2.8	Automatic measurement starting ON or OFF	30
6.2.9	Switch automatic cycle on or off	31
6.2.10	Lighting on or off	31
6.2.11	Change settings for ZERO	32
6.3	Settings for the measurements	32
6.3.1	Select product	32
6.3.2	Perform ZERO measurement	33
6.3.3	Using the input field in the measurement window.....	33
6.3.4	Check the Operation of the Device	34
6.4	Measuring	35
6.5	Measurement data and device information	37
6.5.1	Recall data	37
6.5.2	Graphical display of the measurement data	37
6.5.3	Transferring measurement data.....	37
6.5.4	Deleting measurement data	37
6.5.5	Call device information.....	38
6.5.6	Call log	38
6.6	Updating the software	38
6.6.1	Update the user interface software	38
6.6.2	Updating the software of the basic unit.....	39
6.6.3	Update the software in expert mode	39
6.7	Save user and product data	39
6.8	Restore user and product data.....	40
6.9	Restoring factory defaults	40
6.10	Calibrating the device.....	40
6.10.1	Reasons for calibration	40
6.10.2	Calibration means	40

6.10.3 Leak rate calibration.....	41
6.10.4 Inner volume calibration.....	41
6.10.5 Outer volume calibration.....	41
6.10.6 Check calibration of inner volume.....	42
6.10.7 Check calibration of outer volume.....	43
6.11 Call active errors and warnings.....	44
6.12 Logging off from the device.....	44
6.13 Switching off the device.....	44
7 Warning and error messages.....	45
7.1 List of warning and error messages.....	45
8 Cleaning and maintenance.....	50
8.1 Cleaning the housing.....	50
8.2 Cleaning the membrane.....	51
8.3 Cleaning hoses.....	51
8.4 Check inline filter.....	52
8.5 Replace inline external filters.....	52
8.6 Replace textile mesh.....	52
8.7 Replace membrane support with membranes.....	53
8.8 Change membrane type or chamber size in settings.....	55
8.9 Velcro tape replacement.....	56
8.10 Replacing filter mat on bottom of device.....	56
8.11 Replacement of the measuring chamber hinges.....	57
8.12 Replacement of the measuring chamber spring.....	57
8.13 Perform valve cleaning (only if instructed by service department).....	58
8.14 Perform test for pressure sensors (only if instructed by service department).....	59
8.15 Creating screenshots.....	59
8.16 Service by the manufacturer.....	59
8.17 Sending for repair or maintenance.....	59
8.18 Maintenance plan.....	60
9 Decommissioning the measuring instrument.....	61
9.1 Disposing of the device.....	61
9.2 Returning the device for maintenance, repair or disposal.....	61
10 Appendix.....	63
10.1 Accessories and spare parts.....	63
10.2 Operate leak detector via web browser (LAN).....	64

10.2.1 Configure the LAN connection of the leak detector	64
10.2.2 Setting the LAN connection in the PC or Tablet	65
10.2.3 Allow client access	65
10.3 Data request or control via network	66
10.3.1 Export measurement data.....	66
10.3.2 Export ZERO measurements.....	67
10.3.3 Change and control settings	67
10.4 CE Declaration of Conformity.....	70
Index.....	72

1 About this manual

This document applies to the software version stated on the title page.

Product names may occur in the document, which are added for identification purposes only and belong to the respective owner of the rights.

1.1 Warnings

 DANGER

Imminent hazard resulting in death or serious injuries

 WARNING

Hazardous situation resulting in potential death or serious injuries

 CAUTION

Hazardous situation resulting in minor injuries

**NOTICE**

Hazardous situation resulting in damage to property or the environment

1.2 Target groups

This instruction manual is aimed at the operator of the device, at technically qualified specialists, and trained personnel.

2 Safety

2.1 Intended use

The device is a leak detector, in which test objects are tested for leaks in the foil chamber.

- Only operate the device as intended, as described in the operating instructions, in order to avoid hazards due to incorrect use.
- Comply with application limits, see "Technical Data".

Incorrect usage

Avoid the following unintended uses:

- Use outside the technical specifications, see "Technical Specifications"
- Use in radioactive areas
- Close the measuring chamber, while your fingers are in the swing area of the measuring chamber
- Use of accessories or spare parts, which are not included in this instruction manual
- Test of test objects that touch the sealing lips of the foil chamber
- Test of test objects, where no gas is enclosed (e.g. vacuum packaging).
- Test of sharp objects
- Test of wet or damp test objects
- Test of test objects that contain liquids.
- Test of test objects with significant differences in temperature to the environment
- Contaminating the measuring chamber or the sealing lips.
- Using the device in potentially explosive atmospheres

Note: This device is not intended to be used in living areas.

2.2 Duties of the operator

- Read, observe, and follow the information in this manual and in the work instructions provided by the owner. This concerns in particular the safety and warning instructions.
- Always observe the complete operating instructions for all work.
- If you have any questions about operation or maintenance that are not answered in this operating instructions, contact customer service.

2.3 Owner requirements

The following notes are for companies or any person who is responsible for the safety and effective use of the product by the user, employees or third parties.

Safety-conscious operation

- Operate the device only if it is in perfect technical condition and has no damage.
- Only operate the device properly in accordance with this instruction manual, in a safety and risk conscious manner.
- Adhere to the following regulations and observe their compliance:
 - Intended use
 - Universally valid safety and accident prevention regulations
 - International, national and local standards and guidelines
 - Additional device-related provisions and regulations
- Only use original parts or parts approved by the manufacturer.
- Keep this instruction manual available on site.

Personnel qualifications

- Only instructed personnel should be permitted to work with and on the device. The instructed personnel must have received training on the device.
- Make sure that authorized personnel have read and understood the instruction manual and all other applicable documents.

2.4 Dangers

The measuring instrument was built according to the state-of-the-art and the recognized safety regulations. Nevertheless, improper use may result in risk to life and limb on the part of the user or third parties, or damage to the unit or other property may occur.

Hazards due to liquids and chemicals

Liquids and chemical substances can damage the instrument.

- Do not suck up liquids with the instrument.

- Never try to find toxic, caustic, microbiological, explosive, radioactive or other harmful substances with the device.

Dangers from electric power There is a danger to life from the contact of conductive parts inside the device.

- Disconnect the device from the power supply prior to any installation and maintenance work. Make sure that the electric power supply cannot be reconnected without authorization.

The device contains electric components that can be damaged from high electric voltage.

- Before connecting to the power supply, make sure that the mains voltage on site is within the permitted operating voltage range.

The permitted operating voltage range is indicated on the device.

3 Shipment, Transport, Storage

Scope of delivery

Item	Quantity
Leak detector (basic unit) with standard membrane or with flexible membrane	1
Power supply cable	1
Specimen (CON-Check)	1
Textile mesh	6
Operating manual	1
Quick Guide to Measurement Settings	1
Unpacking instructions	1

- ▶ Check the scope of delivery after receipt of the product to make sure it is complete.

CAUTION

Risk of injury from lifting the heavy device

The device weighs approx. 54 kg and can slip out of your hands.

- ▶ Lift and transport the device only with two people.
- ▶ Grip under the bottom plate to lift.

Transport

NOTICE

Damage caused by transport

Transport in unsuitable packaging material can damage the device.

- ▶ Keep the original packaging.
- ▶ Only transport the device in its original packaging.

Storage

Always store the device in compliance with the technical data, see “Technical data [▶ 18]”.

NOTICE

Losses due to overly prolonged storage

The functional safety of the membranes of the measuring chamber is limited.

- ▶ Do not store membranes for more than 3 years.
- ▶ Store the leak detector or other membranes in a dry place and protected from light.

4 Description

4.1 Function

The device is a leak detector and can be used for non-destructive testing of food packaging containing gas for leaks. The type of gas does not matter for the measurement.

Measuring principle

You place the test objects between the two elastic membranes of the foil chamber. By pumping air from the foil chamber a pressure gradient is created between the test object and the foil chamber. Due to this pressure gradient, gas flows through any leakage from the test object in the foil chamber increasing the pressure there. This pressure rise allows the device to calculate the leak rate of the test object.

Gross leak detection

If there is a gross leak (e.g. torn packaging, non-welded seam), the gas contained in the test object may be completely pumped out by the device. After pumping all the air there will be no pressure rise within the foil chamber so that a test object will be shown to be leak-proof without any gross leak detection.

For reliable detection of gross leaks, you can activate the gross leak detection. If the observed volume does not reach a product-specific value, the message "Gross leak" appears.

4.2 Device setup

4.2.1 Overall device

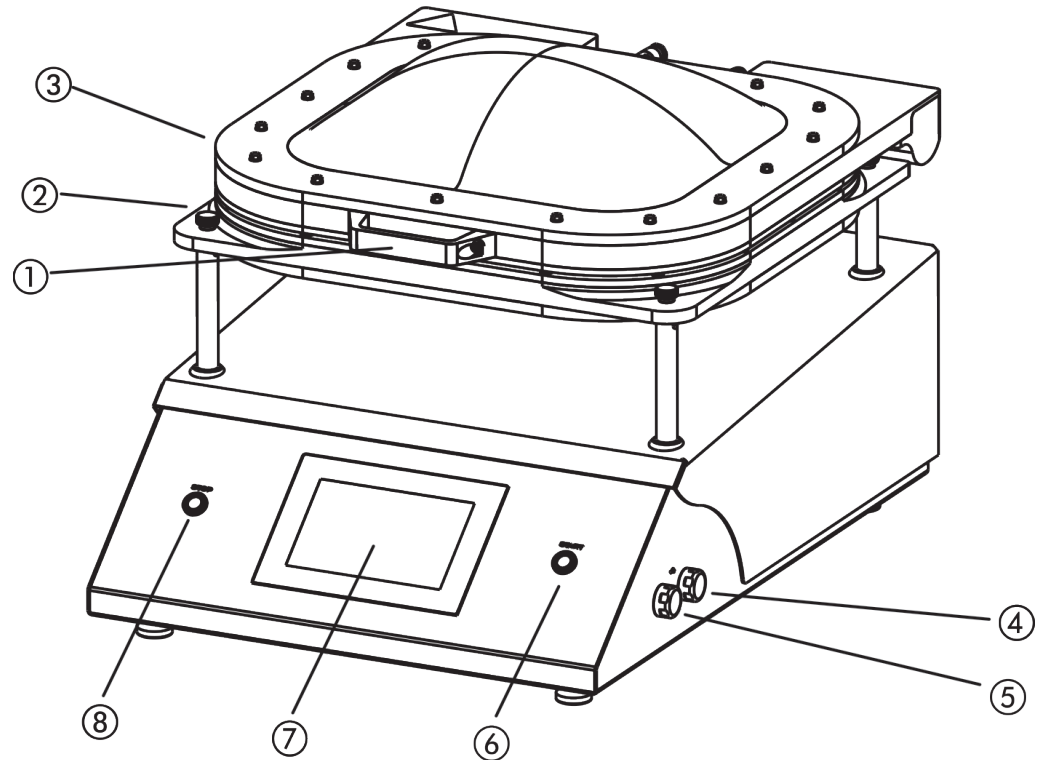

Fig. 1: Front view

1	Measuring chamber handle	5	USB 2.0 interface
2	Knurled nut To release the measuring chamber. To replace the measuring chamber, the hose connections on the rear of the unit also need to be released.	6	"START" button to start the measurement green = ready for measurement
3	Measuring chamber	7	Touchscreen
4	USB 2.0 interface	8	"STOP" button to stop the measurement red = error or warning

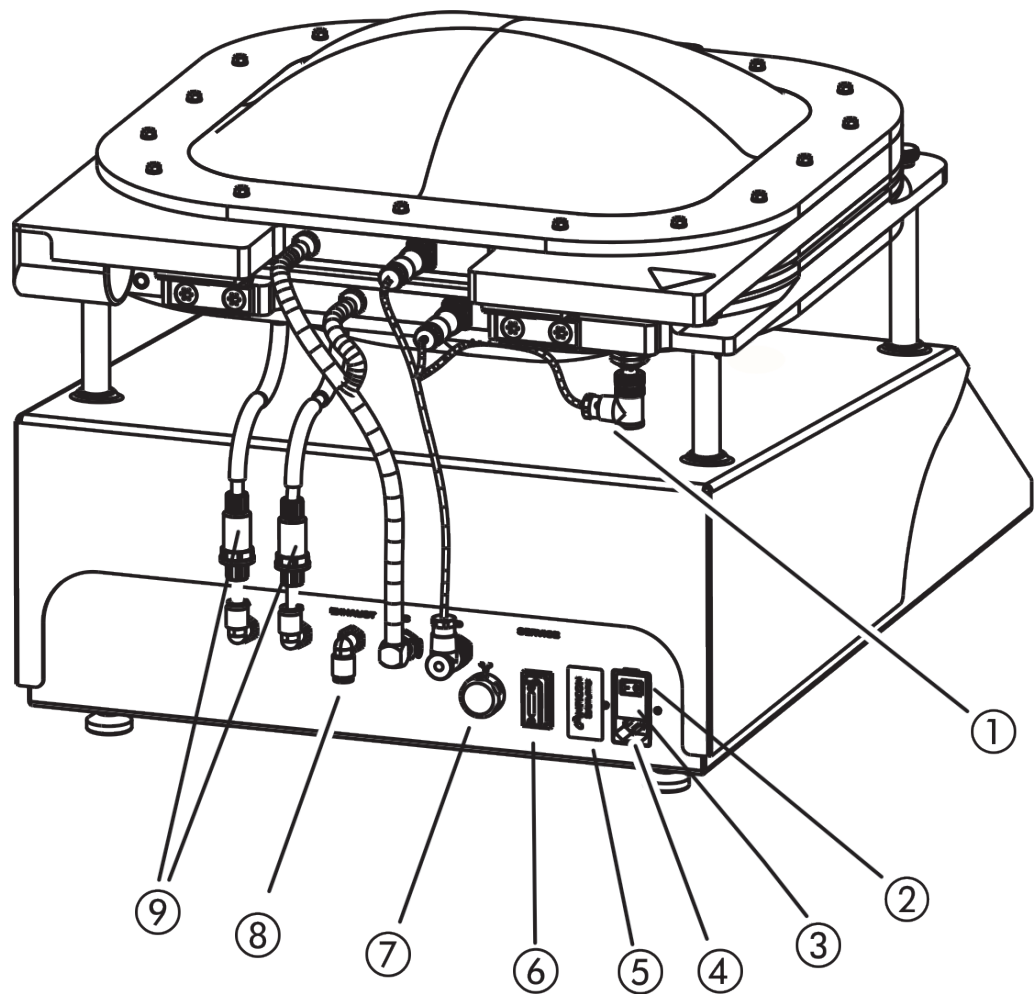

Fig. 2: Back view

1	Connector for proximity switch (for automatic measurement start)	6	RS232 interface
2	Device power ON/OFF switch	7	RJ45 network interface
3	Electrical fuse	8	Without function, exhaust air opening is on the underside
4	Power cable connection	9	Filter elements (inline filter), connected to the terminals A and B
5	Nameplate with specifications concerning mains voltage, serial number and production date		



4.2.2 Markings on the device

The markings on the device have the following meanings:



Li-ion

Label for the returns to the recycling circuit.

-  Device cannot be scrapped with the normal domestic waste.
-  Hand injuries warning

4.3 Display

4.3.1 Assembly of the touchscreen

The display is a touchscreen and works primarily with symbols.



The touchscreen responds to being touched lightly. To correctly select the chosen function, avoid strong pressure.

You can always see symbols for the navigation on the display. You can also see other symbols and elements depending on the context.

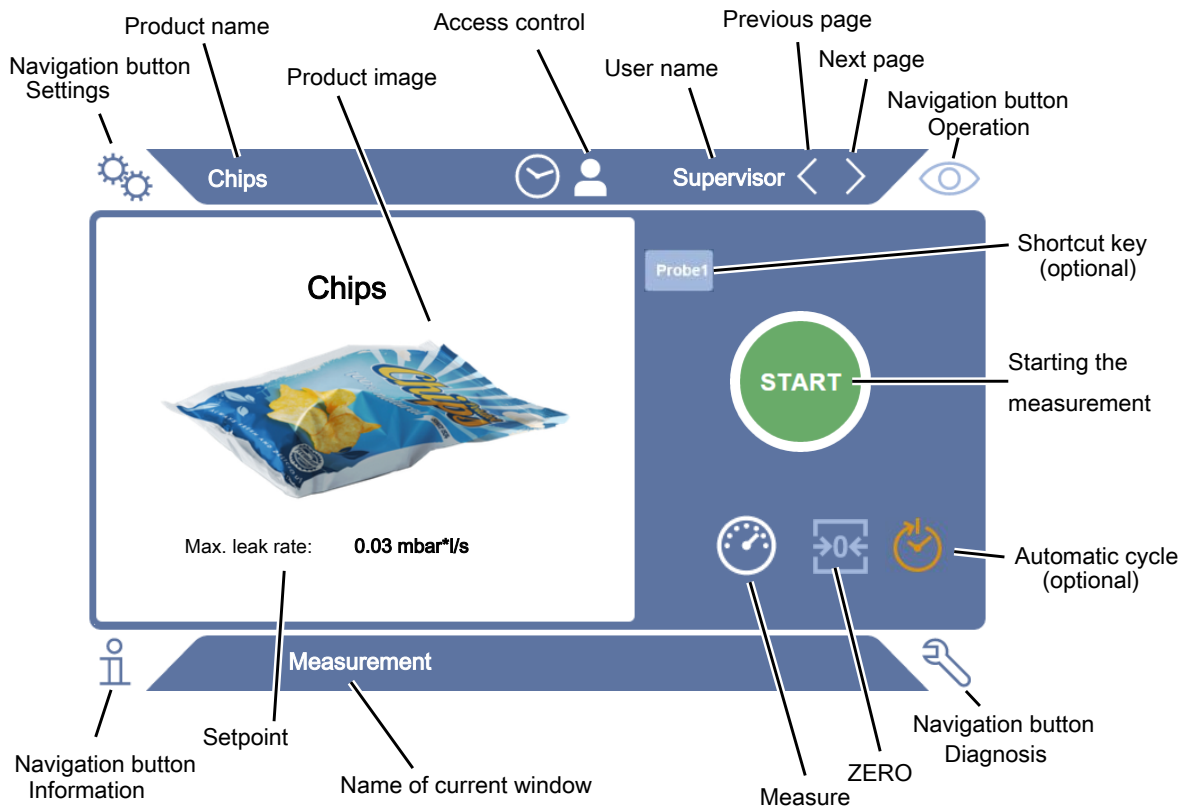

Navigation buttons

The buttons can appear in five different colors:

- Gray: Function is disabled
- Dark blue: Function can be activated
- Light blue: Function is active
- Red: Error is active (navigation button diagnosis)
- Orange: Warning is active (navigation button diagnosis)

 **Settings**

 **Operation**

 **Information**

 **Diagnosis**

Table 1: Navigation buttons

Function buttons

Different colors indicate the status of the function buttons.

The buttons can appear in three different colors:

- Gray: Function is disabled,
- Light blue: Function can be activated,
- White: Function is active.

General function symbols

 Cancel ongoing function

 Call up help for the current function

 Confirm entry or selection

 Load

 Analysis

 Save

 Edit

 Copy

 Delete

 Page forward

 Page back

Table 2: Function buttons

The measurement result is displayed in the measurement window on the left. For more information, see Result display [▶ 17].

4.3.2 Result display

The measured leak rate is highlighted in color and numerically in the "Measurement" window on the left side.

Measurement result:
Leak-proof

If the leak rate is below the setpoint, the measurement result is shown on a green background.

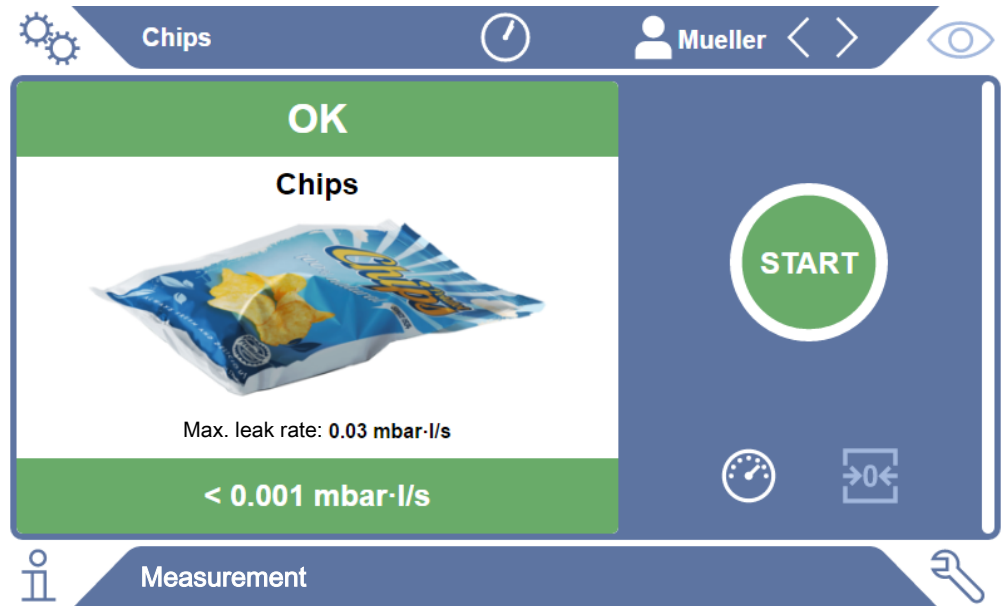

Fig. 3: The measurement display is underlined in green when the test object has passed

Measurement result:
Leaking

If the leak rate is above the setpoint or there is a gross leak, the measurement result is shown on a red background.

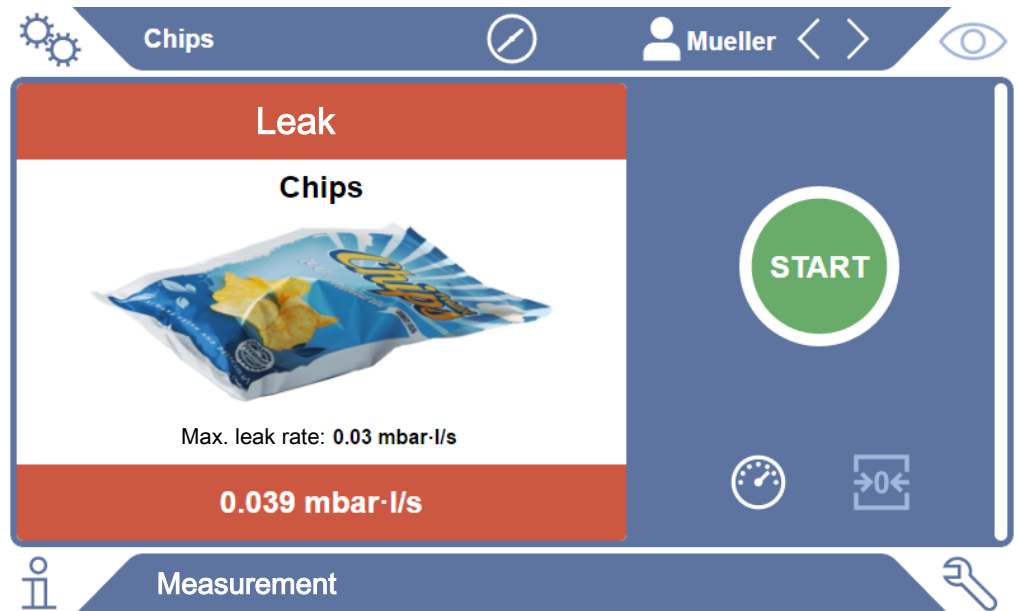

Fig. 4: Red-underlined measuring display at an excessively high leak rate

4.4 Technical data

Mechanical data

	570-000, 570-002
Name	Contura S400
Dimensions (lxwxh)	700 mm x 480 mm x 500 mm
Weight	54 kg
Usable chamber size	400 mm x 350 mm x 200 mm
Max. volume test object at volume measurement	0,5 l
Max. volume test object in leak detection mode	2,5 l
Max. weight of test object	2,5 kg
Housing material	Stainless Steel

Electrical data

	570-000, 570-002
Name	Contura S400
Main fuse	T 3,15 A, 250 V
Output	350 VA
Operational voltage	100 - 240 V \pm 10%, 50 / 60 Hz
Type of protection	IP20D
Excess voltage category	II
Electronic interfaces	USB, RS232, RJ45

Physical data

	570-000, 570-002
Name	Contura S400
Shortest measurement time	< 12 s
Run-up time	< 3 min
Minimum detectable leakrate	< 1 · 10 ⁻³ mbar l/s
Smallest detectable hole diameter	< 10 μ m

Ambient conditions

	570-000, 570-002
Name	Contura S400
Max. altitude above sea level	2000 m

	570-000, 570-002
Max. relative humidity above 40 °C	50%
Max. relative humidity from 31 °C to 40 °C	80% to 50% (decreasing linearly)
Max. relative humidity to 40 °C	80%
Storage temperature	0°C - 60°C
Pollution degree	2
Max. temperature difference test object/ environment	max. 5°C
Permissible ambient temperature (during operation)	10°C - 40°C

Noise emission

	570-000, 570-002
The A-weighted emission sound pressure level at the operator's premises is less than 55 dB (A) at all times for all foreseeable uses of the device. The noise emission measurement declaration was drawn up in accordance with the harmonized standard DIN EN ISO 3744:2011.	

4.5 Factory settings

Illumination of the measuring chamber	On
Auto login	On
Default user	Supervisor
Supervisor PIN (default)	1111
Pre-set product	Universal
Measuring mode	Universal
Measuring time	10 seconds
Automatic start of measurement	On
Automatic cycle	Off
Shortcut keys	Off
ZERO - Mandatory	On
ZERO autostart disabled	On
ZERO time interval	30 minutes
ZERO measurement interval	50 measurements
Volume	0
Lighting	On
Optional input field	Off

5 Installation

5.1 Setup

- In order not to distort the measurement results, select a location where the possible room temperature for the device is constant.
- In order not to block the exhaust opening on the lower part of the device, place the feet of the unit on a firm even surface.
- To easily reach the power switch on the back of the device, ensure there is sufficient free space behind the device.
- Do not expose the device to direct sunlight.

WARNING

Danger from moisture and electricity

Moisture entering the device can lead to personal injury due to electric shocks as well as damage to property due to short circuiting.

- ▶ Only operate the device in a dry environment.
- ▶ Operate the device away from sources of liquid and moisture.

CAUTION

Risk of injury from lifting the heavy device

The device weighs approx. 54 kg and can slip out of your hands.

- ▶ Lift and transport the device only with two people.
- ▶ To lift get hold below the floor panel.

NOTICE

Material damage from overheated device

The device heats up during operation and can overheat without sufficient ventilation.

- ▶ Please note the technical specifications.
- ▶ Ensure sufficient ventilation, especially on the ventilation slots on the left and right of the device: There should be free space in the front, to the rear and sides of the unit of at least 10 cm.
- ▶ Keep heat sources away from the device.

5.2 Connecting to the power supply system

WARNING

Danger from electric shocks

Improperly earthed or protected products may be dangerous to life in case of a fault. The use of the device is not permitted without a connected protective conductor.

- ▶ Only use the included 3-wire power cable.

5.3 USB interface usage

You can connect a barcode scanner or a USB flash drive via the two USB 2.0 interfaces. The USB flash drive must be formatted with the FAT32 file system. FAT32 is a file system which has been compiled as an industry standard and is used as an exchange format across operating system boundaries.

You can perform the following actions with the USB flash drive:

- Transfer stored measurement data, see "Transferring measurement data [▶ 37]",
- Perform software updates, see "Updating the software [▶ 38]".
- Transfer user and product information, see "Save user and product data [▶ 39]" and "Restore user and product data [▶ 40]".

5.3.1 Configure barcode scanner

Configure your barcode scanner as follows:

- 1** Interface selection: "Keyboard"
 - ⇒ The USB barcode scanner should behave like a keyboard connected to a PC.
- 2** Selection of the final delimiter: "Carriage Return" or "CR".
 - ⇒ This configures the character that is sent after the barcode is output.
- 3** Language selection: "English US"
 - ⇒ The leak detector requires an English (US) keyboard layout.

To test the configuration of the scanner, connect it to a PC and use a text editor to check the output of the scanner.

5.4 Other interfaces

RS232 interface

Interface for controlling the leak detector using the LD protocol, see also "Protocol Descriptions, document jira91en1".

RJ45 network interface

Interface for connection to a network, see also “Operate leak detector via web browser (LAN) [▶ 64]”.

See also

 Overall device [▶ 13]

6 Operation

6.1 Switch on and login



- ▶ To switch on the device, press the power button.
 - ⇒ When delivered the device shows the measurement screen.

6.2 Basic settings

6.2.1 Setting the language

You can set the language in the user settings, see "Select, modify, create user profile [▶ 24]".

6.2.2 Setting date, time and time zone

- ✓  **Supervisor** rights
 - 1  > Date and time
 - 2 Adjust.
 - 3 Save .

6.2.3 User profile settings

6.2.3.1 Overview of Rights Groups

The rights of a user depend upon which group he belongs to.

User

Members of the group  **User** can

- select between saved products,
- perform ZERO measurements,
- perform measurements,
- view history of the measurement results,
- view device information,
- view error logs.

Operator

Members of the group  **Operator** have all the rights of the group **User**. Moreover, they can

- create / modify / delete products,
- create / modify / delete users,



- create / modify / delete images,
- export / delete measurement data,
- modify measurement settings.

Supervisor

Members of the group  **Supervisor** have all the rights of groups **User** and **Operator**. Moreover, they can

- create / modify / delete operators,
- create / modify / delete supervisors,
- Perform software updates
- modify date / time.

6.2.3.2 Select, modify, create user profile

✓   **Operator** or **Supervisor** rights

1  > User accounts > Manage user accounts

⇒ Existing users and associated groups are displayed in list form.

2 You have the following possibilities:

To create a new user profile, select  at the bottom of the window.

⇒ The window "User settings" will open.

Otherwise, press an already created user name and choose from the tool bar:

, to load a user profile.

⇒ The login window opens.

, to modify a user profile.

⇒ The window "User settings" will open.

, to delete a user profile.

⇒ A confirmation screen appears.

3 After selection some tools the window "User Settings" opens. In this case, as needed enter a user name, change it or keep it.

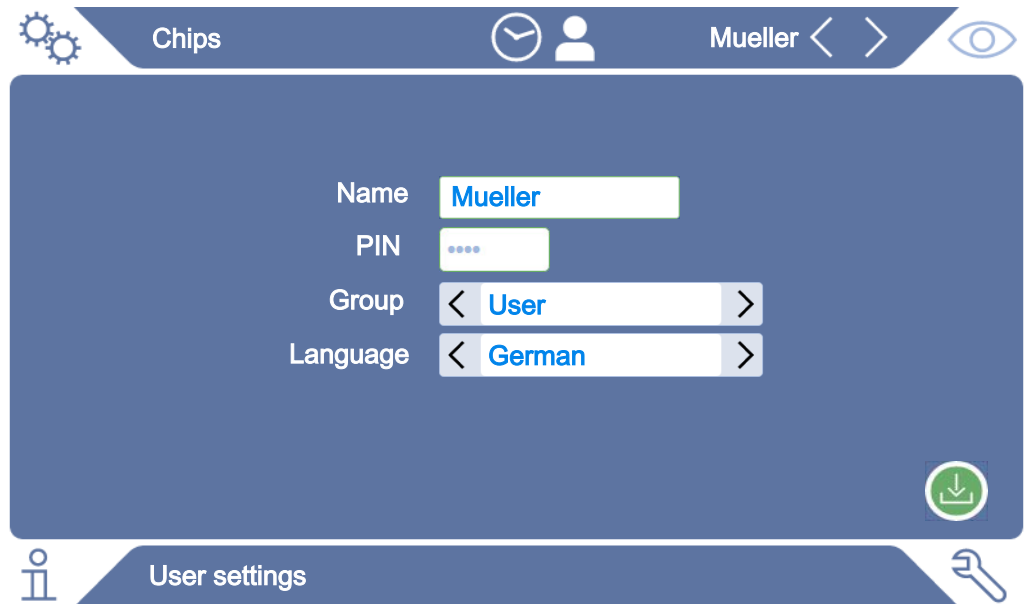

- 4 If the "PIN" field is not filled in or you want to change the content, enter a 4-digit PIN.
- 5 To assign the required rights to the user, select a group. Via < and > select between the groups "User", "Operator" and "Supervisor". See "Overview of Rights Groups [▶ 23]".
- 6 In the field "Language" assign a language to the user via < and >.
- 7 Save .

See also

 [Modify Personal Settings \[▶ 25\]](#)

6.2.3.3 Modify Personal Settings

As a user with limited rights (**User**) you can also modify your language or PIN. By this the associated user profile is correspondingly adapted. Access to the entire user profile is not necessary.

- 1 Press on your name which appears on the top right of the display.
⇒ The "User options" window opens.
- 2 Depending on requirement select either the button "Change PIN" or "Change language".

6.2.4 Switch off Automatic Login





Factory setting

As per factory settings, after switching on the device the user "Supervisor" automatically logs in and the measurement screen is called. This default user also has the permissions of the group "Supervisor". Without changing this setting, any user can operate all functions without restriction.

You can specify that the login window appears after you turn on the device instead of automatically logging on.

In the login window, all users can login, which have been already registered in the device, see "Select, modify, create user profile [▶ 24]".

✓ Supervisor rights

- 1  > User accounts > Manage Automatic Login
- 2 Deactivate in the window "Auto Login" the option "Active".
- 3 Save .



⇒ After restarting the device, the current settings are applied.

6.2.5 Switch on Automatic Login

You can specify if a user of your choice is automatically logged in after the device is switched on without the login window.

✓ Supervisor rights

✓ The requested user was already created. See "Select, modify, create user profile [▶ 24]".

- 1  > User accounts > Manage Automatic Login
- 2 Enter the name of the user in the "Name" window. Note the uppercase/lowercase.
- 3 Enter the current PIN of the user profile in the "PIN" window.
- 4 Activate in the window "Auto Login" the option "Active".
- 5 Save .

6.2.6 Product-specific settings

In the next two chapters the setting of the "measuring mode" and details on the product such as "Max. leak rate" will be handled. If you still have questions left after reading, please contact us.

6.2.6.1 Determine the Measuring mode

Using the pre-set Measuring mode "Universal" you can measure packaging of different sizes and strengths.



Undesired measurement results in the Measuring mode "Universal" are possible



Seriously damaged packaging (gross leaks) could be shown as "Leak-proof" in testing, because when evacuating the measuring chamber, the filling gas is completely sucked out of the packaging.

- ▶ In order to detect larger leaks, select another measuring mode for your product from the table below. In this way the gross leak detection will also take into consideration the packaging.

Measuring Mode / Packaging Size	For example	Gross leak detection	Testing several packages
Universal Packages of different sizes and strengths	All types of gas filled packages	Deactivated	Possible
Small & Soft Less than 500 ml			Possible. The inaccuracy of the measurement results increases with the number of the packages. The measurement result is dependent on constant volume packaging. Total volume < 500 ml. Only same number of packaging per measurement cycle.
	Sausage packaging, individually wrapped salami sausage	By outer volume	
Large & Soft Greater than 500 ml		By evaluating the leak rate	Possible. Only same number of packaging per measurement cycle.
	Chips bag		
Small & Rigid Recommended up to 500 ml			Possible. Only same number of packaging per measurement cycle. Depending on the inner volume even with large numbers.
	Coffee capsules, and soft packaging with individual products and sufficient cavity (nuts)	By gas filled inner volume	
Large & Rigid Recommended above 500 ml			Possible. Only same number of packaging per measurement cycle. Depending on the inner volume even with large numbers.
	Peanut can	By gas filled inner volume	

6.2.6.2 Select, modify or create product (measurement settings)

For setting measurement specifications you need a product that has been created.

✓   **Operator** or **Supervisor** rights

1  > Products

⇒ Existing products are displayed as a list.

2 Press a product name and choose from the displayed tool-bar or from the display:

, to load a product.

, to modify product settings.

⇒ The window "Product Settings" will open.

, to copy product settings.

⇒ The "Product Settings" window opens with the entries of the copy source.

, to delete a product.

⇒ A confirmation screen appears.

, to create a new product.

⇒ The window "Product Settings" opens.

3 After using some tools, the window "Product Settings" opens. In this case, enter under "Product Name" a product name as required, change it or keep it.

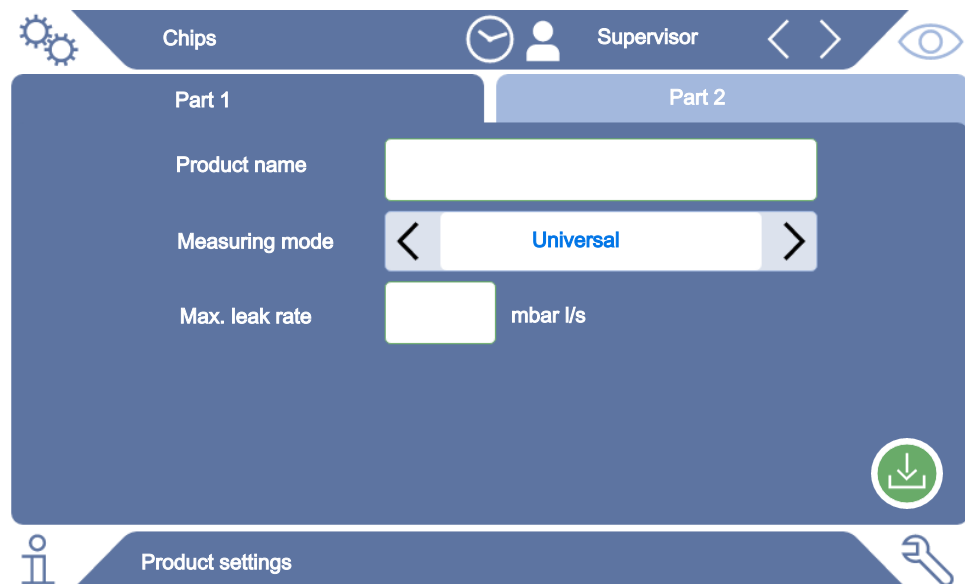

4 Select the "Measuring Mode", see "Determine the Measuring mode [▶ 26]".

5 Under "Max. Leak rate", enter the value at which the product is to be reported as "leaking". The default setting is 0.01 mbar l/s.



- 6 Fill in the on-screen fields "Max. inner volume", which depends on the measuring mode, for the information of the gas filled inner volume or the "Min. outer volume".
- 7 Switch to the tab "Part 2".
- 8 Select the "measurement time" from the displayed time intervals.
 - ⇒ There are different intervals to choose from. A longer measurement time improves the accuracy of the results.
- 9 Enter an optional name for a production batch.
- 10 To enter a barcode, use the touchscreen to enter or scan the bar code in the activated input field.
- 11 Via "Select Image" load a product image that will be displayed on the screen during the measurement.

If your image is not stored on the device, expand the image database. After pressing **+** you can transfer images (JPG, PNG; max. 400 x 400 px) from a USB flash drive (FAT32 format) to the image database.
- 12 Save .

6.2.6.3 Create product variants

If you want to mark a partial quantity of a product, for example, a batch, you can create a variant of the product in question. This eliminates the need to create the same product again and to assign a measuring mode.

To create product variants, you need a product that has already been created.

✓   **Operator** or **Supervisor** rights

1  > Products

⇒ Existing products are displayed as a list.

2 Press a product name and select from the toolbar  that appears.

⇒ A window opens in which any variants that have already been created are displayed in a list overview.

3 To create a new entry, press **+**.



4 Enter the desired name under "Variant name".

5 To enter the optional "variant barcode", use the touchscreen for input or scan the barcode when the input field is activated.

6 Save .

6.2.6.4 Assigning shortcut keys to products

✓ You have created products, see "Select, modify or create product (measurement settings) [▶ 28]".

✓   **Operator** or **Supervisor** rights

1  > Product favorites

- 2 Highlight the desired shortcut key (maximum 6) and press the "Edit" button.
⇒ The "Product favorite" window is displayed.
 - 3 "Name" field: Assign a short name for the shortcut key of the desired product. Depending on the width of the letters, you can save between 3 and 6 letters.
 - 4 "Product" field: After pressing this button, select a product from the list of your created products.
 - 5 "Variant" field: After pressing this button you can choose from the list of your product variants, see also "Create product variants [▶ 29]".
 - 6 Save .
- ⇒ After saving, the edited shortcut key is displayed in the measurement window. See also "Assembly of the touchscreen [▶ 15]".



Remove shortcut key

- ▶ To stop using a shortcut key in the measurement screen, select the desired shortcut key after the first step.
- ▶ Press .

6.2.7 Changing the volume

In addition to the visual display of the measurement result a beep is sounded. You can change the volume of the beep.



WARNING

Risk of injury due to loud noise emissions

The device can emit sounds at the highest level of the set volume up to a level of 100 dB (A).

- ▶ Set a volume up to a maximum of "50".
- ▶ Use suitable hearing protection at set volumes above "50".

✓ Operator or Supervisor rights



- 1  > Device
- 2 Adjust.
- 3 Save .

6.2.8 Automatic measurement starting ON or OFF

If you select the function "Measurement" or "ZERO" and then close the measurement chamber, the selected process is started automatically. For this purpose, the signal from a proximity switch is used.

The option "Autostart" is activated in the factory settings. You can switch the "Autostart" option on or off.

✓  **Operator** or **Supervisor** rights

- 1  > Device
- 2 Adjust.
- 3 Save .

⇒ If the automatic measurement start is OFF, press the "START" button on the touchscreen or on the housing to start the measurement.

6.2.9 Switch automatic cycle on or off

In order to ensure a very high accuracy of each measurement, we recommend keeping the ventilation time during which the chamber is open as constant as possible.

Activating the "Automatic cycle" helps with this. If you activate this function, the measuring process starts automatically when a preset time has passed between measurements. Close the chamber beforehand and wait until the measuring process is started automatically.



The "Automatic cycle" option is deactivated in the factory setting. You can switch the "Automatic cycle" option on or off.



The "Automatic cycle" is independent of the "Automatic measuring start" setting, which works via a proximity switch. See also "Automatic measurement starting ON or OFF [▶ 30]".

To avoid different starting behavior, "Automatic measuring start" should be switched off when using the "Automatic cycle".

✓  **Operator** or **Supervisor** rights

- 1  > Device
- 2 Make your selection in the "Automatic cycle" field.
- 3 Save .

⇒ Activation of "Automatic mode" is also displayed in the measuring window with . If you want to interrupt the "Automatic cycle" for a break, press this symbol in the measuring window. The color then changes to green.
You need special rights to pause or continue "Automatic mode" via fingerprint.

6.2.10 Lighting on or off

The option "Lighting" is enabled by factory settings. Switching off the lighting has no effect on the measurement result.

✓  **Operator** or **Supervisor** rights

- 1  > Device

- 2 Adjust.
- 3 Save .

6.2.11 Change settings for ZERO

To compensate for external influences such as air pressure or temperature on the measurement, carry out ZERO measurements regularly when the measuring chamber is empty. This helps to maintain accuracy of measurements. When certain conditions occur, you will be prompted to perform ZERO measurements, see also “Perform ZERO measurement [▶ 33]”.

You can deviate from the factory settings and change the frequency of prompts for ZERO measurement. You can also set whether you can ignore ZERO prompts and continue measurements.

✓  **Supervisor** rights

- 1  > ZERO
- 2 To set that ZERO prompts must be followed, enable the “ZERO - Mandatory” option.
 - ⇒ If this option is activated, it is not possible to continue measurements without a previous ZERO measurement when prompted to take a ZERO measurement.
 - ⇒ To set ZERO prompts to be ignored, deselect the “ZERO - Mandatory” option.
- 3 To prevent a filled measuring chamber from being evaluated as a supposed ZERO measurement when the hood is closed when a ZERO prompt is active, activate the “ZERO autostart disabled” option.
 - ⇒ This prevents the automatic measurement start when the hood is closed.
- 4 Under “ZERO time interval” you have the option of setting how many minutes after the last ZERO measurement the prompt for the next ZERO measurement should be issued or whether it should be switched off.
- 5 Under “ZERO measurement interval” you have the possibility to set after how many measurements after the last ZERO measurement the request for the next ZERO measurement should be made or whether it should be switched off.
 - ⇒ After a ZERO measurement, the counter for both “ZERO time interval” and “ZERO measurement interval” is reset to “0”.

6.3 Settings for the measurements

6.3.1 Select product

- 1  > Products

⇒ Existing products are displayed. If you cannot find the desired product, you can create it, see "Select, modify or create product (measurement settings) [▶ 28]".

2 Click the desired product name.

3 Load .

⇒ You will be asked to perform a ZERO measurement.

Alternative procedure

✓ You have already created shortcut keys with the desired product favorites, see also "Assigning shortcut keys to products [▶ 29]".

1 Call up the measurement screen.

⇒ The measurement screen appears automatically after a user logs in.
Alternatively, press .

2 Press the shortcut key with the desired product. See also "Assembly of the touchscreen [▶ 15]".

6.3.2 Perform ZERO measurement



To compensate for external factors such as air pressure or temperature on the measurement, perform ZERO measurements in the following cases as described below:

- ▶ After a prompt on the display
- ▶ Before starting a series of measurements
- ▶ At least once an hour in measuring mode

1 Select  > .

2 Empty the measuring chamber.

3 Start the ZERO measurement.

⇒ The result is displayed in green and the values are taken over. In the event of a fault, the result is displayed in red.

6.3.3 Using the input field in the measurement window

If required, you can set up an input field in the measurement window to enter an additional information text there. For example, a batch number.

This text is not only displayed in the measurement window, but is also logged during data recording. The text is assigned to the measurement performed.

1. Setting up the input field for the measurement window

1  > Device

- 2 Activate the "Optional input field".
- 3 Save .

2. Fill or change input field in measurement window

- ✓ You have activated the optional input field.
 - 1 Touch the input field in the measurement window.
 - 2 Enter the desired text using the keyboard that appears.
- ⇒ After restarting the device, the input field is empty.



6.3.4 Check the Operation of the Device

You have the possibility to check the function of the device with the help of the supplied CON-Check (test specimen).

The CON-Check simulates leak rates in the range of 0.018 ± 0.006 mbar l/s.



If you want to check with a higher leak rate, you have the alternative option to place multiple Con-Checks or a Pac-Check in the measuring chamber. In order to ensure the proper functioning of the device (measurement result: Leaky, red), adjust the maximum leak rate accordingly.

- 1  > Products
 - ⇒ In addition to other products, the product "Con-Check" will be shown according to factory settings.
- 2 Click the product name "Con-Check".
- 3 Load .
 - ⇒ You will be asked to do a ZERO measurement with an empty measuring chamber, see "Perform ZERO measurement [▶ 33]".
 - ⇒ Loading the Con-Check sets a permissible maximum leak rate that is less than the leak rate simulated by the Con-Check. This allows the result of the test to report a leak.
- 4 Place the CON-Check in the measuring chamber on its own.
- 5 Start the measurement process.
 - ⇒ If the CON-Check is identified as leaking for exceeding the maximum permissible leak rate, the device is working properly, see "Result display [▶ 17]".
The measured leak rate should be in the range of 0.018 ± 0.006 mbar l/s.

6.4 Measuring



⚠ CAUTION

Warning about hand injuries

Only open and close the measurement chamber when your fingers are outside the measuring chamber halves and outside the pivoting range of the measuring chamber.

NOTICE

Damage by improper filling of the measuring chamber

Leaking liquids entering the tubing, can interfere with the function of the device. Sharp objects, fats or oils may damage the textile mesh, membrane, chamber ring and sealing lips.

- ▶ Only check dry packaging or packages that do not contain liquids.
- ▶ Avoid contamination of the measuring chamber by oils, fats, or hydrocarbons.
- ▶ Do not use sharp edged objects without protective frame in the measuring chamber.



Avoid measuring inaccuracies:

- ▶ Place packages so that the gaskets of the measuring chamber halves are not covered or touching!
- ▶ Avoid measuring test objects with significant differences in temperature to the surroundings!
- ▶ Keep the gaskets of the measuring chamber halves clean. If you do not remove contaminants, measuring results may be distorted.

- ✓ You have made general settings, see "Basic settings [▶ 23]".
- ✓ You have saved the settings for the desired product in the device, see Product-specific settings [▶ 26].
- ✓ You have selected the desired product, see "Select product [▶ 32]".
- ✓ You have carried out a ZERO measurement before changing a product line and at regular intervals, see "Perform ZERO measurement [▶ 33]".
 - 1 Call up the measurement screen.
 - ⇒ The measurement screen appears automatically after a user logs in. Alternatively, press .
 - 2 Place the test object in the measuring chamber.
 - 3 Close the measuring chamber and start the measurement. Regarding the start options, also see the descriptions in "Automatic measurement starting ON or OFF [▶ 30]".



- 4** If you want to cancel the measurement, press the "STOP" button on the front side of the device, see Device setup [▶ 13].
- ⇒ The measured leak rate is highlighted in color and numerically in the "Measurement" window on the left side. In addition, the word "OK", "Leak", "Gross leak" or "Empty chamber" appears, see "Result display [▶ 17]". After completion of the measurement you can remove the test object and measure additional test objects.





If you repeat the measurements with the same test object, the measurement results may differ. This is usually due to a reduced amount of filling gas caused by the previous measurement.

6.5 Measurement data and device information

6.5.1 Recall data



- 1  > Measurements
 - ⇒ The measurements performed are displayed in short form line by line.
 - 2 To display the detailed view of a measurement, tap on an entry and then on the displayed symbol .
 - ⇒ All information stored for this measurement is displayed.
- ⇒ When the results are displayed, the following abbreviations are used:
- "GL" = Gross leak
 - "NP" = No test object in chamber



6.5.2 Graphical display of the measurement data

- 1  > Chart
 - ⇒ The display shows the measurement data of the set time interval.
- 2 To set the time interval and the measurement of products, select . You can limit both the measurement period and the products displayed.

6.5.3 Transferring measurement data

Measurement results are automatically saved in the device. The last 500,000 measurements are saved. You can transfer measurement data from the internal memory to a connected USB flash drive.

✓   **Operator** or **Supervisor** rights

- 1 To transfer data from the internal memory, connect a USB flash drive with FAT32 formatting to any of the USB ports of the device. See also "USB interface usage [▶ 21]".
- 2  > Measurements
- 3 Save .



⇒ All measurement data are transferred. There is an indication when the export is completed. The measurement data remain saved on the device.

See also

 Data request or control via network [▶ 66]

6.5.4 Deleting measurement data

You can delete measurement data from the internal memory of the device.

✓   **Operator** or **Supervisor** rights

1  > Measurements

2 Press .

⇒ All measurement data is deleted.

6.5.5 Call device information

▶  > Device information

⇒ The stored information will be displayed.

6.5.6 Call log

Button to display device messages in list form. This information is useful when you contact the manufacturer's service.

▶  > Protocol

6.6 Updating the software

The device has two different software versions: One for the user interface and one for the basic unit. Each has its own independent versions number.

6.6.1 Update the user interface software

Import software updates using a USB flash drive.

NOTICE

Data loss due to an aborted connection

▶ Do not switch off the device and do not remove the USB flash drive while the software is being updated!

1 Copy the file into the main directory of a FAT32 formatted USB flash drive.

2 Connect the USB flash drive to a USB port on the device.

3  > Update > Update operating unit

⇒ At the top in the window the active software version of the user interface is shown.

If one or more versions of the software are on the USB flash drive the most recent version is shown on the line below. If this is the same as the version already installed the background is green, otherwise it is red.

4 In order to load the new software version, press on the button "Update".

⇒ After completion there is an automatic restart of the operating unit.

6.6.2 Updating the software of the basic unit

Import software updates using a USB flash drive.



NOTICE

Data loss due to an aborted connection

- ▶ Do not switch off the device and do not remove the USB flash drive while the software is being updated!

- 1 Copy the file into the main directory of a FAT32 formatted USB flash drive.
- 2 Connect the USB flash drive to the USB port on the device.
- 3  > Update > Update Basic Unit
 - ⇒ At the top in the window the active software version of the basic unit is shown.
If one or more versions of the software are on the USB flash drive the most recent version is shown on the line below. If this is the same as the version already installed the background is green, otherwise it is red.
- 4 In order to load the new software version, press on the button "Update".
 - ⇒ After completion there is an automatic restart of the system.

6.6.3 Update the software in expert mode

- 1  > Update > Update operating unit > Experte
 - ⇒ Software versions already available on the device are shown in a list.
- 2 Highlight any of the software versions as required and proceed to step 5.
 - ⇒ Resetting to an older software version is possible.
- 3 If alternatively you want to add a new software version, connect a FAT32 formatted USB flash drive with the update file to one of the USB ports of the device.
- 4 In order to load the new software version, press on .
- 5 To activate the new version, select the desired list entry and press .
 - ⇒ After completion there is an automatic restart of the system.

6.7 Save user and product data

You can save all user and product data to a USB flash drive and restore whenever necessary.



No backup of measurement data

When backing up user and product data no measurement data backup is performed. To backup measurement data see "Transferring measurement data [▶ 37]".

✓  **Supervisor** rights

- 1 Insert a FAT32-formatted USB flash drive into a USB port on the device.
- 2  > Data backup > Back up data

6.8 Restore user and product data



Overwrite current user and product data

By restoring stored user and product data the current state of these data is deleted.

✓  **Supervisor** rights

✓ You have a USB flash drive (FAT32 formatted) with user and product data from a backup.

- 1 Insert the USB stick into a USB port on the device.
- 2  > Data backup > Restore data

6.9 Restoring factory defaults

You can restore the device to factory settings.



Loss of settings and measurement data

After resetting to factory defaults only the manufacturer factory settings is in the memory of the device.

Backup important settings and measurement data beforehand on a USB flash drive.

See "Save user and product data [▶ 39]" and "Transferring measurement data [▶ 37]".

✓  **Supervisor** rights

- ▶  > Reset device

6.10 Calibrating the device

6.10.1 Reasons for calibration

In the following cases, calibration is mandatory:



- The installation site of the leak detector is located above 1000 m above sea level.
- The measuring chamber was changed.
- There are operational requirements for a calibration.

6.10.2 Calibration means

There are various calibration means for the device available:



- Pac-Check (Catalog number 572-000).
The Pac-Check allows you to calibrate the leak rate.
- Calibration Kit (Catalog number 573-000).
The calibration kit lets you calibrate the leak rate and in addition the inner and outer volumes.

6.10.3 Leak rate calibration

- ✓  **Supervisor** rights
- ✓ You have a Pac-Check.
 - 1  > Calibration
 - ⇒ The "Calibration" window opens in which you can calibrate "Leak rate", "Inner volume" and "Outer volume".
 - 2 To calibrate the leak rate using a calibration leak, select "Leak rate" in the selection field and enter the leak rate of the calibration leak in mbar l/s in the next field.
 - 3 Press  and follow the instructions on the screen.
 - ⇒ You will now be prompted to perform a ZERO measurement and then to measure the calibration leak.
 - ⇒ After calibration the determined calibration factor is displayed in the window "Calibration".



6.10.4 Inner volume calibration

The internal volume is evaluated in the measuring modes "Small & Rigid" and "Large & Rigid" for the large scale detection, see also "Determine the Measuring mode [▶ 26]".

- ✓  **Supervisor** rights
- ✓ You have a blue specimen rod from the calibration kit (setting inner volume 20 ml).
 - 1  > Calibration
 - ⇒ The "Calibration" window opens.
 - 2 Select "Inner volume" in the selection field and then follow the instructions on the screen.
 - ⇒ After the ZERO measurement, place the test specimen in the center of the measuring chamber.
 - 3 Press .



6.10.5 Outer volume calibration

The outer volume is evaluated in the measuring mode "Small & Soft" for the gross leak detection, see also "Determine the Measuring mode [▶ 26]".

- ✓  **Supervisor** rights
- ✓ You have a red specimen rod from the calibration kit (setting outer volume 100 ml).
 - 1  > Calibration
 - ⇒ The "Calibration" window opens.
 - 2 Select "Outer volume" in the selection field and then follow the instructions on the screen.
 - ⇒ After the ZERO measurement, place the test specimen in the center of the measuring chamber.
 - 3 Press .

6.10.6 Check calibration of inner volume

With the test specimens from the calibration kit, you can also check the calibration of the inner volume:

- 1  > Products
 - ⇒ Existing products are displayed as a list.
- 2 Mark any product that has already been assigned the measuring mode "Small & Rigid", see also "Determine the Measuring mode [▶ 26]".
 - ⇒ Agreement between the dimensions and the test specimens is not important.
 - ⇒ If you do not find such a product in your list, create a new product, for example "blue test specimen", see also "Select, modify or create product (measurement settings) [▶ 28]".
- 3 Download the product via .
- 4 Perform a ZERO measurement, see also "Measuring [▶ 35]".
- 5 Call up the measurement screen.
- 6 Place the blue test specimen in the center of the measuring chamber.
- 7 Close the measuring chamber and start the measurement.
 - ⇒ The result "leak-proof" or "leaking" is not important, but only the fact that the inner volume is measured and can be viewed elsewhere.
- 8 Then measure the green test specimen in the center of the measuring chamber (optional).
- 9  > Measurements
 - ⇒ The information stored on the measurements that were carried out above are displayed.
 - ⇒ Due to the "Small & Rigid" measuring mode used, the list display also contains information on the measured inner volume of the test specimens.

- 10** Compare the data displayed there for the measured test specimens with the known dimensions of these test specimens.

Test specimen bar blue: Inner volume 20 ml



Test specimen bar green: Inner volume 10 ml



A deviation of approx. 4 ml is within the range of the tolerance and does not affect the gross leak detection.

6.10.7 Check calibration of outer volume

With the test specimens from the calibration kit, you can also check the calibration of the outer volume:

- 1**  > Products
 - ⇒ Existing products are displayed as a list.
- 2** Mark any product that has already been assigned the measuring mode "Small & Soft", see also "Determine the Measuring mode [▶ 26]".
 - ⇒ Agreement between the dimensions and the test specimens is not important.
 - ⇒ If you do not find such a product in your list, create a new product, for example "Red test specimen", see also "Select, modify or create product (measurement settings) [▶ 28]".
- 3** Download the product via .
- 4** Perform a ZERO measurement, see also "Perform ZERO measurement [▶ 33]".
- 5** Call up the measurement screen.
- 6** Place the red test specimen in the center of the measuring chamber.
- 7** Close the measuring chamber and start the measurement.
 - ⇒ The result "leak-proof" or "leaking" is not important, but only the fact that the outer volume is measured and can be viewed elsewhere.
- 8** Then measure the second and then the third specimen (optional).
- 9**  > Measurements
 - ⇒ The information stored on the measurements that were carried out above are displayed.
 - ⇒ Due to the "Small & Rigid" measuring mode used, the list display also contains information on the measured outer volume of the test specimens.
- 10** Compare the data displayed there for the measured test specimens with the known dimensions of these test specimens.
 - Test specimen bar red: Outer volume 100 ml
 - Test specimen bar blue: Outer volume 50 ml
 - Test specimen bar green: Outer volume 50 ml



A deviation of approx. 5 ml is within the range of the tolerance and does not affect the gross leak detection.

6.11 Call active errors and warnings

Active errors

Errors or warnings are displayed on the active user interface. In addition, the diagnosis symbol changes color .

1  > Errors and warnings

⇒ The "Errors and warnings" button is only available while errors or warnings are active. Errors and warnings are displayed in list form.

2 To perform measurements, confirm active errors or warnings with the "Clear" button.

⇒ The information displayed is closed.

See also "Warning and error messages [▶ 45]".

6.12 Logging off from the device

1 Press on your name which appears on the top right of the display.

⇒ The "User options" window opens.

2 You log off from the device via the button "Log off".

⇒ The login window opens.

6.13 Switching off the device.

You can switch off the device at the mains switch at any time. The parameters set in the device remain saved.

7 Warning and error messages

During operation, the display shows information that helps you operate the instrument. Measurement values are displayed along with current unit modes, operating instructions as well as warnings and error messages. The instrument is equipped with extensive self-diagnostic functions. If the electronics detect a faulty state, the device will show this as far as possible on the display and will interrupt operation.

Warnings

Warnings warn of instrument modes that can impair the accuracy of measurements. To perform measurements, confirm active warnings with the "Clear" button.

Error messages

Errors are events that force the interruption of the operation. The error message consists of a number and a descriptive text. Once you have found the cause for the error continue operation by pressing the button "Clear".

Touchscreen

You will find an overview of possible errors and warnings on the touchscreen:

▶  > Help > Errors and warnings

See also

 Call active errors and warnings [▶ 44]

7.1 List of warning and error messages

Type	Notification	Possible sources of error	Remedy
W102	Timeout during communication with EEPROM in internal I/O module	The EEPROM in the internal I/O module is defective or not present	<ul style="list-style-type: none"> • Contact customer service
W104	One EEPROM parameter has been initialized	A new parameter was introduced by a software update	<ul style="list-style-type: none"> • Confirm the warning message • Check that the message does not appear when you restart the device • Check whether the factory setting of the new parameter corresponds to your application
		The EEPROM in the internal I/O module is defective	<ul style="list-style-type: none"> • Confirm the warning message • Check if the message occurs each time when you restart the device • Contact customer service

Type	Notification	Possible sources of error	Remedy
W106	Several EEPROM parameters have been initialized	A software update introduced new parameters	<ul style="list-style-type: none"> • Confirm the warning message • Check that the message does not appear when you restart the device • Check whether the factory setting of the new parameters corresponds to your application
		The EEPROM in the IO module was empty	<ul style="list-style-type: none"> • Confirm the warning message • Check that the message does not appear when you restart the device • Check whether the factory setting of the new parameters corresponds to your application
		The EEPROM in the internal I/O module is defective	<ul style="list-style-type: none"> • Confirm the warning message • Check if the message occurs each time when you restart the device • Contact customer service
W110	Real-time clock was reset! Enter date and time	The real-time clock has not been set	<ul style="list-style-type: none"> • Enter the correct date and time • Check that the message does not appear when you restart the device
		Battery in internal I/O module is discharged or defective	<ul style="list-style-type: none"> • Contact customer service
		Real-time clock defective	<ul style="list-style-type: none"> • Contact customer service
W127	Wrong bootloader version	The bootloader is not compatible with application	<ul style="list-style-type: none"> • Contact customer service
W151	No communication with operating unit	A software update or a parameter reset has been executed	<ul style="list-style-type: none"> • Confirm the warning message • Check that the message does not appear when you restart the device
		Internal connection problem between the basic unit and the operating unit	<ul style="list-style-type: none"> • Contact customer service

Type	Notification	Possible sources of error	Remedy
W170	Hood open	Measurement started with chamber open	<ul style="list-style-type: none"> • Measure with closed chamber
		Proximity switch not connected	<ul style="list-style-type: none"> • Contact customer service
		Proximity switch not calibrated	<ul style="list-style-type: none"> • Contact customer service
		Proximity switch defective	<ul style="list-style-type: none"> • Contact customer service
W201	24 V power supply too low	Malfunction of 24V power supply unit	<ul style="list-style-type: none"> • Contact customer service
		Short circuit or overload in the 24V supply	<ul style="list-style-type: none"> • Contact customer service
W202	24 V power supply too high	Malfunction of 24V power supply unit	<ul style="list-style-type: none"> • Contact customer service
W315	Measurement aborted	Measurement was aborted	<ul style="list-style-type: none"> • Repeat the measurement
E317	Volume too large	Placed product is too large for volume determination	<ul style="list-style-type: none"> • Change the measuring mode • Insert fewer products • Perform a ZERO measurement • Volume measurement recalibration
W355	Internal volume measurement negative	Error with internal volume measurement	<ul style="list-style-type: none"> • Perform a ZERO measurement
W372	Incorrect filter pressure sensor	Error in pressure sensor	<ul style="list-style-type: none"> • Turn the power off to the device and check if the message appears again when you turn on the power • Contact customer service
E500	Pressure sensor p1 not connected	Pressure sensor not connected or cable defective	<ul style="list-style-type: none"> • Restart the device and check the function • Contact customer service
		Internal I/O module defective	<ul style="list-style-type: none"> • Contact customer service
		Pressure sensor p1 defective	<ul style="list-style-type: none"> • Contact customer service
E511	Pressure sensor p2 not connected	Pressure sensor not connected or cable defective	<ul style="list-style-type: none"> • Contact customer service

Type	Notification	Possible sources of error	Remedy
E520	Pressure too high	Leak in the valve block	<ul style="list-style-type: none"> • Check that the message does not appear when you restart the device • Contact customer service
		Pump is defective	<ul style="list-style-type: none"> • Contact customer service
E530	Leak in measuring chamber	Chamber not closed	<ul style="list-style-type: none"> • Close the measuring chamber during the measurement
		Large product with gross leakage	<ul style="list-style-type: none"> • Repeat the measurement
		Leak in the chamber	<ul style="list-style-type: none"> • Check the hose connections of the measuring chamber • Contact customer service
W540	Pressure too low	Pressure too low	<ul style="list-style-type: none"> • Check filter and replace if necessary • Contact customer service
E560	Leak in gasket	Target pressure not reached	<ul style="list-style-type: none"> • Remove a large product with gross leakage • Check the hose connections of the measuring chamber • Check filter and replace if necessary • Contact customer service
W561	Leak in outer gasket	Contaminated chamber seal	<ul style="list-style-type: none"> • Clean the chamber seal
		Particles on valve seats	<ul style="list-style-type: none"> • Perform valve cleaning • Contact customer service
		Damaged chamber seal	<ul style="list-style-type: none"> • Check the chamber seal and replace it if necessary
		Hose connection (A) leaking	<ul style="list-style-type: none"> • Check the hose connection (A) and replace it if necessary
		Filter leaking	<ul style="list-style-type: none"> • Check filter and replace if necessary
		Internal hose connection leaking	<ul style="list-style-type: none"> • Contact customer service
W562	Leak in valve block	Contaminated valve block	<ul style="list-style-type: none"> • Repeat the measurement • Perform valve cleaning • Contact customer service
		Defective valve block	<ul style="list-style-type: none"> • Contact customer service

Type	Notification	Possible sources of error	Remedy
E564	Valve fault	Valve sticking	<ul style="list-style-type: none"> • Repeat the measurement
		Valve defective	<ul style="list-style-type: none"> • Perform valve cleaning • Contact customer service
W600	Calibration factor too low	Incorrect value entered at calibration	<ul style="list-style-type: none"> • Repeat the calibration
		Wrong calibration leak inserted	<ul style="list-style-type: none"> • Repeat the calibration
		ZERO measurement error	<ul style="list-style-type: none"> • Repeat the calibration
W601	Calibration factor too high	Incorrect value entered at calibration	<ul style="list-style-type: none"> • Repeat the calibration
		Wrong calibration leak inserted	<ul style="list-style-type: none"> • Repeat the calibration
		ZERO measurement error	<ul style="list-style-type: none"> • Repeat the calibration
		Background too high	<ul style="list-style-type: none"> • Use the purge function to reduce the background • Repeat the calibration
E660	Leak in the membrane	Zero measurement with product in the chamber	<ul style="list-style-type: none"> • Perform a ZERO measurement
		Chamber diaphragm leaking	<ul style="list-style-type: none"> • Check membrane and replace if necessary
		Hose connection (A) leaking	<ul style="list-style-type: none"> • Check the hose connection (A) and replace it if necessary
		Filter leaking	<ul style="list-style-type: none"> • Check filter and replace if necessary
W682	Calibration volume too small	Incorrect value entered at calibration	<ul style="list-style-type: none"> • Repeat the calibration
		Incorrect specimen inserted	<ul style="list-style-type: none"> • Repeat the calibration
		ZERO measurement error	<ul style="list-style-type: none"> • Repeat the calibration
		Hose connection (C) leaking	<ul style="list-style-type: none"> • Check the hose connection (C) and replace it if necessary

8 Cleaning and maintenance

All cleaning and maintenance work described here must be carried out without opening the device hood out of stainless steel!

DANGER

Risk of death from electric shock

There are high voltages inside the device. Touching parts where electrical voltage is present can result in death.

- ▶ Disconnect the device from the power supply prior to any cleaning and maintenance work. Ensure that the electrical supply cannot be switched back on unintentionally.
 - ▶ Do not open the stainless steel unit housing!
-

8.1 Cleaning the housing

The housing of the device is made of stainless steel and the measuring chamber is made of plastic.

- 1 Make sure that the device is disconnected from the power supply by disconnecting the power supply plug.
- 2 When cleaning the measuring chamber, use an agent accepted for synthetic surfaces (for example a light household cleaner). Do not use any solvents that attack synthetic materials.

8.2 Cleaning the membrane

There are black membranes at the top and bottom of the measuring chamber. There is a textile mesh stretched over each membrane.



Fig. 5: Loosen the netting

1	Textile mesh	2	Velcro tape
3	Membrane		

- 1 Pull the textile mesh carefully from the Velcro tape and wipe the membrane with a soft damp cloth.
Use only warm water to moisten. Avoid cleaning agents that contain alcohol, fat or oil.
- 2 Make sure the membrane is completely dried.
- 3 Attach the textile mesh with slight tension to the Velcro tape, by pressing on the opposite sides of the Velcro tape.



Make sure that the textile mesh does not protrude from either side of the Velcro tape and the function of the chamber sealing is not impaired.

8.3 Cleaning hoses

With leak testing the air pumped out of the chamber via two hoses, and there are filter cartridges on the end of each, see "Device setup [▶ 13]". If a little liquid or condensation has entered the hoses they can be dismantled by a specialist with technical training.

- 1 To dismantle the hoses, press the release rings toward the housing or measuring chamber and disconnect each hose along with the filter cartridge.
⇒ If a larger amount of liquid has reached the bottom of the tubing, contact the service.
- 2 Clean the tubes and dry them for example by blow-drying.

- 3 If necessary, replace of the filter cartridges, see "Replace inline external filters [▶ 52]".
- 4 Refit the hoses.

8.4 Check inline filter

Function and measuring accuracy of the leak detector can be impaired by contaminated filters. Check the transparent filter elements (inline filter) regularly for the ingress of dust.

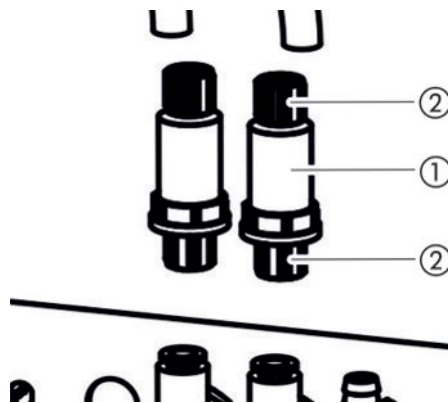

Fig. 6: Filter elements on the rear of the device

- | | |
|--------------------------------|---------------------|
| 1 Filter element (transparent) | 2 Union nuts (blue) |
|--------------------------------|---------------------|

- ▶ Change the filter elements if there is considerable contamination, see "Replace inline external filters [▶ 52]".

8.5 Replace inline external filters

Filter set	Order number 200006373
Required tools	None

The inline filters are also changed every 4 years as part of the manufacturer's service, see also "Service by the manufacturer [▶ 59]".

- 1 To disconnect the hoses from the filter elements on the rear of the device, loosen the blue cap nuts with your fingers, see "Check inline filter [▶ 52]".
- 2 Replace the contaminated filter element with a new filter element. Note the direction of mounting!
- 3 Tighten the blue screw caps of the filter element.

8.6 Replace textile mesh

Textile mesh	Use the supplied mesh fabric or order a set with 10 pieces: Order number 200006379
--------------	--

Required tools	None
----------------	------

- 1 Gently pull the used textile mesh from the Velcro tape. See also "Cleaning the membrane [▶ 51]".
- 2 If necessary, wipe the membrane with a cloth.
- 3 Attach the new textile mesh under slight tension to the Velcro tape. Press it on the opposite sides of the Velcro tape. To avoid wrinkling, pull the textile mesh as evenly as possible.



Make sure that the textile mesh does not protrude from either side of the Velcro tape and the function of the chamber sealing is not impaired.

8.7 Replace membrane support with membranes

Upper membrane support, with standard membrane	Send in for repair or order, order number 200006376
Lower membrane support, with standard membrane	Send in for repair or order, order number 200006368
Upper membrane support, with flex membrane	Send in for repair or order, order number 200010700
Lower membrane support, with flex membrane	Send in for repair or order, order number 200010701
Required tools	T25 screwdriver

During a measurement, two mesh-protected membranes nestle from the top and from the bottom in the test object due to the pumping action.

The membranes may be leaking, so that accurate measurements are no longer possible. Causes of damage can be sharp edged objects, aging or wear. Remove the membrane support including the damaged membrane.

If you want a repair, please send the diaphragm carrier with membrane to the manufacturer. Due to the high quality requirements at the manufacturer, the membrane support is re-tensioned, the components are tested and then a leak testing is performed.

Dismantling the membrane support

- ✓ At least one membrane no longer functions properly or has to be replaced for reasons of age.
 - 1 Open the measuring chamber and determine which membrane is damaged. For this you can remove the mesh, see "Cleaning the membrane [▶ 51]".
 - 2 If it is necessary to remove the upper membrane support including the damaged membrane, unscrew the 16 screws with a T25 screwdriver.

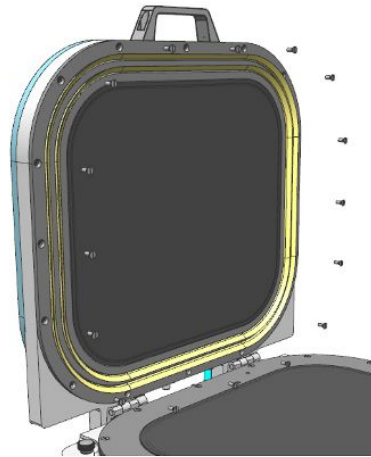

- 3 If it is necessary to remove the lower membrane support including the damaged membrane, first pull both hoses from the bottom of the measuring chamber. To detach a hose, first press the release ring on the end of the hose in the direction of the adapter, so that the locking releases and you can remove the hose. Then unscrew the 16 screws with a T25 screwdriver.
- 4 For repair, pack the membrane support, so that it is protected against damage during transport.
- 5 Please do not hesitate to contact us and send a completed declaration of contamination before sending anything to us, see also "Returning the device for maintenance, repair or disposal [► 61]".

Mounting the diaphragm support

- If you sent a membrane support with a defective membrane to the manufacturer, your diaphragm support with membrane and mesh was re-tensioned and leak testing was performed. With an upper membrane support an additional new lip seal also came.
 - If you want to take precautions in the event of damage to a membrane, you can purchase from the manufacturer of the device ready-tensioned upper and lower replacement membrane supports. Note that the service life of stored membranes reduced by opening the original packaging and due to light.
- ✓ They feature a separate membrane support with an intact membrane.
- 1 To assemble the upper membrane support, hold it with the screw holes above the thread openings, and screw the 16 screws hand-tight with a T25 screwdriver. Tighten crosswise with a torque of 4 Nm.
The assembly of the upper membrane support is possible in 2 directions.
 - 2 To install the lower membrane support, insert the membrane support with the screw holes over the provided thread holes. To do this thread the hose connection through the boreholes in the lower membrane support. There is only one mounting direction possible.
Screw the 16 screws hand-tight with a T25 screwdriver. Tighten crosswise with a torque of 4 Nm.
 - 3 To connect the hoses to the hose connections in the lower membrane support as closely as possible in a leak-proof manner, first press the ends of the transparent hose into the provided connections in the lower membrane carrier.

⇒ The release rings fix the transparent hoses.

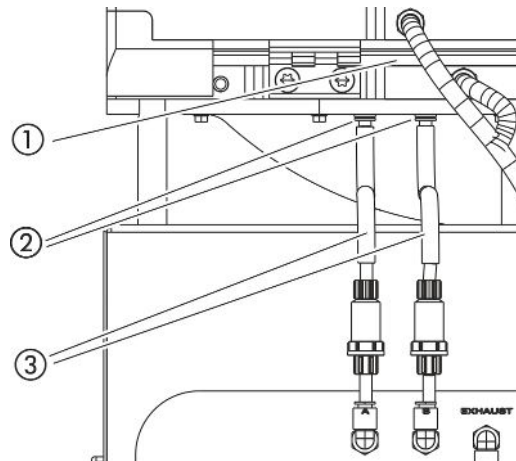

Fig. 7: Position of the hoses

1	Lower membrane support	2	Hose connections
3	Hose guides		

- 4 Slide the black hose guides into a right angle arrangement. This provides strain relief.
- 5 If you switch between membrane carriers with standard membranes and membrane carriers with flex membranes, adjust the device settings. See also "Change membrane type or chamber size in settings [▶ 55]".

8.8 Change membrane type or chamber size in settings

Standard membranes are suitable for many applications. The measurement settings are matched to the membranes used.



Flex membranes are made of a particularly flexible membrane material, which is especially suitable for large test objects with edges.

See also "Accessories and spare parts [▶ 63]".

If you change the membrane type or the chamber size, you must also adjust the corresponding setting in the leak detector.

✓  **Supervisor** rights

✓ Membrane type or chamber size has changed.

- 1  > Device
- 2 Make your choice in the "Chamber" field
 - ⇒ S400 Standard: With standard membrane
 - ⇒ S400 Flex: With flexible membrane
 - ⇒ S600 Standard: With flexible membrane
- 3 Save .

8.9 Velcro tape replacement

Measuring chamber velcro strip (5.6 m long)	Order number 200006378
Required tools	Scissors

Self-adhesive Velcro tape is attached on both membrane supports, on which the mesh is attached. The Velcro tape can be replaced.

✓ Velcro tape no longer functions properly or has to be replaced for reasons of age.

- 1 Gently pull the textile mesh from the Velcro tape.
- 2 Remember how the old Velcro tape is fixed and where there are incisions to follow the curvature of the Velcro tape.
- 3 Remove the old Velcro and any adhesive residues.
- 4 Use the scissors to adjust the length of the new Velcro tape to the length of the old Velcro tape.
- 5 Glue the new Velcro tape onto the membrane support. Make several incisions as with the old Velcro tape to follow the curvature.
Make sure that the new Velcro tape does not touch either the black membrane or the sealing surfaces.

⇒ You can re-attach the textile mesh, see "Replace textile mesh [▶ 52]".

8.10 Replacing filter mat on bottom of device

Filter set	Order number 200006373
Required tools	None

In production rooms with increased dust load, the filter mat on the bottom of the device can become contaminated. Replace the filter mats if there is significant contamination.

The filter mats are also changed every 4 years as part of the manufacturer's service, see also "Service by the manufacturer [▶ 59]".

✓ You have a new filter mat.

- 1 Make sure that the device is disconnected from the power supply by disconnecting the power supply plug.
- 2 To reach the air filter at the bottom of the device, gently tilt the device 90 degrees to the left when viewed from the front.
- 3 Remove the plastic grille. It is only attached by catch tabs.
- 4 Remove the used air filter from the plastic grille and insert a new one.
- 5 Refit the plastic grille together with the new air filter.

8.11 Replacement of the measuring chamber hinges

Measuring chamber hinges (set)	Order number 200006381
Required tools	T45 screwdriver

✓ You have a set with two hinges for the replacement.

- 1 Close the measuring chamber.
- 2 Make sure that the device is disconnected from the power supply by disconnecting the power supply plug.
- 3 On the rear of the device, unscrew the four hinge screws on the lower chamber ring using a T45 screwdriver.
- 4 Carefully open the chamber lid and pull it backwards.

⇒ In this way, the spring is pulled out of the guide of the lower chamber ring.



- 5 In order not to scratch the chamber lid, place it along with the dome on a soft support.
- 6 Unscrew the two screws of each hinge on the inside of the chamber lid.



- 7 Remove the defective hinges and replace them.
- 8 Install in reverse order.

8.12 Replacement of the measuring chamber spring

Measuring chamber spring	Order number 200006389
Required tools	• T25 screwdriver

- T45 screwdriver



- ✓ You have an intact spring for replacing a defective spring.
 - 1 Make sure that the device is disconnected from the power supply by disconnecting the power supply plug.
 - 2 Open the lid of the measuring chamber.
 - 3 Using a T25 screwdriver, unscrew the two screws of the black spring housing and remove the spring housing.
 - 4 Close the measuring chamber.
 - 5 On the rear of the device, unscrew the four hinge screws on the lower chamber ring using a T45 screwdriver.
 - 6 Carefully open the chamber lid and pull it backwards.
 - ⇒ In this way, the spring is pulled out of the guide of the lower chamber ring, see also "Replacement of the measuring chamber hinges [▶ 57]".
 - 7 In order not to scratch the chamber lid with the dome, place it on a soft support.
 - 8 Pull out the defective spring and replace it.





- 9 Install in reverse order.

8.13 Perform valve cleaning (only if instructed by service department)

Small particles on the valve seats can trigger warning message 561. If this warning message occurs several times, contact the service department.

- ✓ You have contacted the service department.
- ✓ The measuring chamber is open.
- ✓  **Operator** or **Supervisor** rights
- ▶  > Valve cleaning
 - ⇒ To remove possible particles, the pump starts up and the valves begin to switch.

8.14 Perform test for pressure sensors (only if instructed by service department)

- ✓ You have contacted the service department.
- ✓  **Supervisor** rights
- ▶  > Sensor test
- ⇒ Both pressure sensors are tested.

8.15 Creating screenshots

You can save the current screen contents of the device to an image file. You can use such a file for service communication, for example.

- 1 Create a directory named "Screenshots" on a USB stick (FAT 32 formatted).
- 2 To take a screenshot, connect the USB stick to one of the USB ports of the leak detector, see also "Overall device [▶ 13]".
 - ⇒ A screenshot is automatically taken and stored in the directory on the USB stick. The date and time are also saved.
- 3 To take another screenshot, disconnect the USB stick from the USB port and then reconnect it to the leak detector.
 - ⇒ A screenshot saved earlier will not be overwritten when another screenshot is taken.

8.16 Service by the manufacturer

Maintenance inside the device should only be performed by the manufacturer. We recommend having the device serviced every four years by the manufacturer's service.

Service package

- Replacement of the diaphragm pump membrane
- Replacement inline internal filters
- Replacement 2-inline external filters
- Replacement of lower side air filter

8.17 Sending for repair or maintenance

You can send the device to the manufacturer for repair or maintenance. For further details see "Returning the device for maintenance, repair or disposal [▶ 61]".

8.18 Maintenance plan

Regardless of the described maintenance cycles a replacement depends on contamination and wear.

Maintenance table

Maintenance cycle	Personnel	Additional information	
Two-yearly	Operating personnel	8.7	Replace membrane support with membranes
4 years	Service personnel	8.16	Service by the manufacturer
5000 measurements	Operating personnel	8.5	Replace inline external filters

9 Decommissioning the measuring instrument

9.1 Disposing of the device

The device can either be disposed of by the operator or be sent to the manufacturer. The device consists of materials that can be recycled. This option should be exercised to prevent waste and also to protect the environment.

- During disposal, observe the environmental and safety regulations of your country.

9.2 Returning the device for maintenance, repair or disposal



⚠ WARNING

Danger due to harmful substances

Contaminated devices could endanger health. The contamination declaration serves to protect all persons who come into contact with the device. Devices sent in without a return number and completed contamination declaration will be returned to the sender by the manufacturer.

- ▶ Fill in the declaration of contamination completely.

- 1** Contact the manufacturer and send in a completed declaration of contamination before return shipment.
⇒ You will then receive a return number and the shipping address.
- 2** Use the original packaging when returning.
- 3** Before shipping the instrument, attach a copy of the completed contamination declaration to the outside of the package.

For contamination declaration see below.

Declaration of Contamination

The service, repair, and/or disposal of vacuum equipment and components will only be carried out if a correctly completed declaration has been submitted. Non-completion will result in delay.
 This declaration may only be completed (in block letters) and signed by authorized and qualified staff.

1 Description of product

Type _____

Article Number _____

Serial Number _____

2 Reason for return

3 Operating fluid(s) used (Must be drained before shipping.)

4 Process related contamination of product:

toxic	no <input type="checkbox"/> 1)	yes <input type="checkbox"/>	
caustic	no <input type="checkbox"/> 1)	yes <input type="checkbox"/>	
biological hazard	no <input type="checkbox"/>	yes <input type="checkbox"/> 2)	
explosive	no <input type="checkbox"/>	yes <input type="checkbox"/> 2)	
radioactive	no <input type="checkbox"/>	yes <input type="checkbox"/> 2)	
other harmful substances	no <input type="checkbox"/> 1)	yes <input type="checkbox"/>	

2) Products thus contaminated will not be accepted without written evidence of decontamination!

The product is free of any substances which are damaging to health
 yes

1) or not containing any amount of hazardous residues that exceed the permissible exposure limits

5 Harmful substances, gases and/or by-products

Please list all substances, gases, and by-products which the product may have come into contact with:

Trade/product name	Chemical name (or symbol)	Precautions associated with substance	Action if human contact

6 Legally binding declaration:

I/we hereby declare that the information on this form is complete and accurate and that I/we will assume any further costs that may arise. The contaminated product will be dispatched in accordance with the applicable regulations.

Organization/company _____

Address _____ Post code, place _____

Phone _____ Fax _____

Email _____

Name _____

Date and legally binding signature _____
Company stamp _____

Copies:
 Original for addressee - 1 copy for accompanying documents - 1 copy for file of sender

10 Appendix

10.1 Accessories and spare parts

	Order number
Filter set	200006373
Upper standard membrane support assembly	200006376
Lower standard membrane support assembly	200006368
Upper flex membrane support assembly	200010700
Lower flex membrane support assembly	200010701
Measuring chamber velcro strip	200006378
Measuring chamber mesh, 10 pcs.	200006379
Measuring chamber hinges (set)	200006381
LED light strip for dome top/bottom	200009949
Measuring chamber spring	200006389
Con-Check	571-000
Pac-Check	572-000
Calibration Kit	573-000

10.2 Operate leak detector via web browser (LAN)

NOTICE

Operating system can be hacked via USB or Ethernet

The Linux operating system used in the leak testing is not updated automatically and can therefore contain security gaps. This vulnerability may be exploited through the Ethernet and USB interfaces of the leak testing to provide unauthorized access to the system.

- ▶ Ensure that no unauthorized person has access to these interfaces, for example by using a USB port / Ethernet port lock.
- ▶ In order not to jeopardize the security of your company network, never connect the leak testing directly to the public Internet. This applies to connections over WLAN as well as over Ethernet.
- ▶ However, if you want to access the web interface of the leak testing remotely, we recommend an encrypted Virtual Private Network (VPN) connection. However, we cannot assume any guarantee for the security of VPN connections, which are provided by third parties.

10.2.1 Configure the LAN connection of the leak detector

✓  **Supervisor** rights

✓ The network cable is connected to the RJ45 network interface on the back of the leak detector.

1  > Network > LAN settings

2 In the "Method" field, select your LAN setting:

- ⇒ Disabled: Even when the network cable (RJ45 socket) is connected, no network connection is established.
- ⇒ DHCP: The leak detector automatically obtains an IP address through the network into which it is integrated.
- ⇒ Static: The IP address, as well as the network mask and gateway have to be configured manually, so that the leak detector can be reached in the network. If necessary, contact a network administrator.

3 Save .

See also

 Setting the LAN connection in the PC or Tablet [▶ 65]

10.2.2 Setting the LAN connection in the PC or Tablet





LAN connection - quick-start

If you have performed the steps described here once, it is sufficient to enter the IP address for many devices in case of repetition.

- ✓ The PC is connected to the same network as the leak detector.
- ✓ A LAN setting has been set up in the configuration of the leak detector, see also "Configure the LAN connection of the leak detector [▶ 64]".
- ✓ You have noted down the IP address of the leak detector. It can be found in the leak detector under "Information > Device > Network".
- ✓ Java Script is enabled in the web browser. We recommend using a current version of the web browser Chrome™, Firefox® or Safari®.
- ▶ To access the leak tester from the PC or tablet web browser, enter the IP address of the leak detector as follows:
http://<IP address>
 - ⇒ The current active user interface of the leak detector is called.
 - ⇒ The same functionality is available on the PC or Tablet as on the touchscreen of the leak detector.

10.2.3 Allow client access

- ✓  **Supervisor** rights
 - 1  > Network > Client access
 - 2 To allow the leak detector to be operated by PC or Tablet, activate the "Client Access" option.
 - ⇒ If the option "Client Access" is not activated, the leak detector cannot be operated via PC or Tablet. No settings can then be changed.
 - 3 Save .



Display of all connected clients

- ✓ The network connection between the leak detector and one or more PCs or Tablets has been established, see "Setting the LAN connection in the PC or Tablet [▶ 65]".
- ▶  > Network > Connected clients

10.3 Data request or control via network

In addition to access to the graphical user interface, you also have the option of retrieving specific measurement data from your leak detector, making settings and sending control commands.

A data interface was implemented for this purpose (REST interface). This interface responds to requests on port 3000 when valid parameters are transmitted with data in the requested format.

10.3.1 Export measurement data

- ✓ A network connection has been established between the leak detector on one side and the PC or Tablet on the other side. See also "Operate leak detector via web browser (LAN) [▶ 64]".
- ▶ In order to export the desired measurement data, you have the option of entering your query with the desired parameters as a URL in your browser. With this procedure, you not only set the desired time period, but you can also choose the file format and data scope.

Example 1:

`http://192.168.11.124:3000/measurement?f=json&pid=4`

Returns all measurements of the product with ID 4 in "json" format.

Example 2:

`http://192.168.11.124:3000/measurement?dts=2018-05-03T07:00:00&dte=2018-05-04T09:00:00&f=csv_de`

Returns all measurements between 2018-05-03 07:00:00 and 2018-05-04 09:00:00 in "csv_de" format.

Parameter	Name	Description	Options	Example
dts	START	Start time of the time period from which the data is to be exported	Date in ISO format	dts=2018-05-03T07:15:00
dte	End	End time of the time period from which the data is to be exported	Date in ISO format	dte=2018-05-04T11:34:12
l	Limit	Limits the number of exported measurements	Number between 1 and 400000	l =100 l = 16
f	Format	Data format of the export	csv_en, csv_de, json Standard: csv_en	f=json f=csv_de
pid	Product	Query measurements of one or more products	ID's of the products. Separated by comma for several	pid=2 pid=4,6,7

Parameter	Name	Description	Options	Example
pvid	product variants	Query measurements of one or more product variants	ID's of the product variants. Separated by comma for several	pvid=12 pvid=8,15,2

See also

 Graphical display of the measurement data [[▶ 37](#)]

10.3.2 Export ZERO measurements

ZERO measurements affect the settings and the displayed leak rate.

For traceability reasons, it may therefore make sense to transfer this data to a central system as well.

For the requirements, see "Export measurement data [[▶ 66](#)]".

Example 1

`http://192.168.11.124:3000/zero?f=json&l=50`

Returns the last 50 ZERO measurements in the format "json"

Example 2

`http://192.168.11.124:3000/zero?dts=2018-05-03T07:00:00&dte=2018-05-04T09:00:00&f=csv_de`

Returns all ZERO measurements between 2018-05-03 07:00:00 and 2018-05-04 09:00:00 in "csv_de" format.

Parameter table as for normal measurements, but without the parameters "pid" and "pvid".

- dts
- dte
- f
- l

10.3.3 Change and control settings

This interface responds to requests on port 3000 with a response in the format "json" when valid parameters are transmitted.

✓ A network connection has been established between the leak detector on one side and the PC or Tablet on the other side. See also "Operate leak detector via web browser (LAN) [[▶ 64](#)]".

▶ To send the desired commands, you have the possibility to enter your request with the desired parameters as URL in your browser.

Change product

Example

`IP-Address:3000/control?cscmd=loadproduct&cmdparam=2,1`

Loads the product with ID 2 and the product variant with ID 1.

The response is either

`{"confirmation":"Product load executed"}` – If the product is available

`{"error":"Product not available"}` – If the product is not available

Change "Measuring mode"

Example 1

IP-Address:3000/control?cscmd=setmode&cmdparam=measurement

Switches the device to the "Measure" mode

Example 2

IP-Address:3000/control?cscmd=setmode&cmdparam=zero

Switches the device to "ZERO" mode

The response is:

`{"confirmation":"Operation mode changed"}` - If successful

`{"error":"Command failed"}` - If failed

Send start/stop

Example

IP-Address:3000/control?ldcmd=1

Starts the set measuring mode (measurement or ZERO)

Example

IP-Address:3000/control?ldcmd=2

Stops the current measuring mode (measurement or ZERO)

The response is:

`{"confirmation":"Command Stop executed"}` - If successful

`{"error":"Command failed"}` - If failed

Query device status

Example

IP-Address:3000/control?cscmd=status

The response is e.g.

`{"stateId":3}`

stateId 1 = Measurement in progress

stateId 3 = Standby

stateId 4 = ZERO in progress

or

```
{"stateId":3,"errors":[{"number":355,"typeId":2,"type":"Warning","text":"Int vol  
negative","value":-8.5}]}
```

If errors or warnings are currently present, these are added.

10.4 CE Declaration of Conformity



EU Declaration of Conformity

We – INFICON GmbH - herewith declare that the products defined below meet the basic requirements regarding safety and health and relevant provisions of the relevant EU Directives by design, type and the versions which are brought into circulation by us. This declaration of conformity is issued under the sole responsibility of INFICON GmbH.

In case of any products changes made, this declaration will be void.

Designation of the product:

Packaging leak detector

Models:

Contura S400

Catalogue numbers:

570-000

570-002

The products meet the requirements of the following Directives:

- ***Directive 2006/42/EC (Machinery)***
- ***Directive 2014/30/EU (EMC)***
- ***Directive 2011/65/EC (RoHS)***

Applied harmonized standards:

- ***EN ISO 12100:2010***
- ***EN 61326-1:2013***
Class A according to EN 55011
- ***EN 61010-1:2010+A1:2019***
- ***EN IEC 63000:2018***

Authorised person to compile the relevant technical files:

Heinz Rauch, INFICON GmbH, Bonner Strasse 498, D-50968 Cologne

Cologne, December 13th, 2022

Cologne, December 13th, 2022

p.p.

Dr. H. Bruhns, Vice President LDT

pro

W. Schneider, Research and Development

INFICON GmbH

Bonner Strasse 498
D-50968 Cologne
Tel.: +49 (0)221 56788-0
Fax: +49 (0)221 56788-90
www.inficon.com
E-mail: leakdetection@inficon.com

**UK
CA**



UK Declaration of Conformity

We – INFICON GmbH - herewith declare that the products defined below meet the basic requirements regarding safety and health, and relevant provisions of the relevant legislation by design, type and the versions, which are brought into circulation by us. This declaration of conformity is issued under the sole responsibility of INFICON GmbH.

In case of any products changes made, this declaration will be void.

Designation of the product:

Packaging leak detector

Models: **Contura S400**

Catalogue numbers:

570-000

570-002

The products meet the requirements of the following Directives:

- **S.I. 2008 No. 1597 (Machinery)**
- **S.I. 2016 No. 1091 (EMC)**
- **S.I. 2012 No. 3032 (RoHS)**

Applied harmonized standards:

- **EN ISO 12100:2010**
- **EN 61326-1:2013**
Class A according to EN 55011
- **EN 61010-1:2010+A1:2019**
- **EN IEC 63000:2018**

Authorised person to compile the relevant technical files:

Heinz Rauch, INFICON GmbH, Bonner Strasse 498, D-50968 Cologne

Cologne, December 13th, 2022

Cologne, December 13th, 2022

p.p.

Dr. H. Bruhns, Vice President LDT

pro

W. Schneider, Research and Development

INFICON GmbH

Bonner Strasse 498
D-50968 Cologne
Tel.: +49 (0)221 56788-0
Fax: +49 (0)221 56788-90
www.inficon.com
E-mail: leakdetection@inficon.com

Index

A		Declaration of Contamination		54, 61, 62
Access controls	23	E		
Additional input field	33	Entering a barcode		29
Auto Login	26	Errors and warnings (active)		44
Automated login		F		
Switch off	26	Factory settings		19
Switch on	26	Flex membrane		53, 55
Automatic cycle		Function buttons		16
on measurement screen	15	Function description		12
Switching on	31	G		
Symbol	31	Gross leak detection		12, 27
Automatic start of measurement	31	I		
Autostart	31	Inner volume calibration		41
B		Inner volume definition		27
Barcode scanner	21	Interfaces		13, 14, 21, 64
C		L		
Calibrate		LAN		64
Check calibration of the inner volume	42	Allow client access		65
Check calibration of the outer volume	43	Configure leak detector		64
Calibrating	40	Settings PC or tablet		65
Inner volume	41	Lighting on or off		31
Leak rate	41	Loading product image		29
Outer volume	42	M		
Calibration kit	41	Maintenance		50
Calibration means	40	Maintenance plan		60
Call log (device messages)	38	Maximum leak rate		28, 34
Changing the volume	30	Measure		
Checking the operation of the device	34	Repeat measurement		36
Cleaning work	50	Requirements		35
Con-Check	34	Measurement data		
D		Bring up		37
Data backup		Delete		37
Measurement data	37	Export via network		66
User and product data	39			
Data recovery				
User and product data	40			
Date & Time	23			

Transfer	37	Update basic unit	39
view	37	User interface update	38
Measuring mode		Storage	11
Large Rigid	27	Supervisor	24, 26
Large Soft	27	Switch OFF	44
Small Rigid	27	Switch ON	23
Small Soft	27		
Universal	26	T	
Measuring principle	12	Take a screenshot	59
Modify Personal Settings	25	Technical data	18
		Touchscreen	15
O		Transfer the product image to the leak detector	29
Operator	23	Transport	11
Outer volume calibration	42		
Outer volume definition	27	U	
		Universal	26
P		USB flash drive	21
Pac-Check	41	User	23
Product		User profile	
Create	28	create	24
Delete	28	Delete	24
Load	28	edit	24
Variants	29	load	24
Product settings		Z	
Copy	28	ZERO	33
Edit	28	Change settings	32
		ZERO measurement	33
R		Meaning	32
Replace membranes	53	perform	33
Restoring factory defaults	40		
Return shipment	59		
Rights	23		
S			
Setpoint	28		
Setting the language	25		
Setting the measurement time	29		
Setup	20		
Shortcut keys			
Create	29		
on measurement screen	15		
use	33		
Software			



Due to our continuing program of product improvements, specifications are subject to change without notice.
The trademarks mentioned in this document are held by the companies that produce them.