

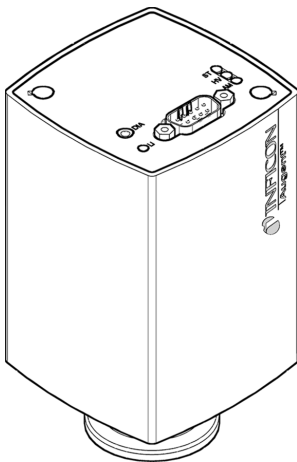

Optical Plasma Gauge

Augent™ OPG550



Operating Manual
Incl. EU Declaration of Conformity

Product Identification

In all communications with INFICON, please specify the information on the product nameplate. For convenient reference copy that information into the space provided below.

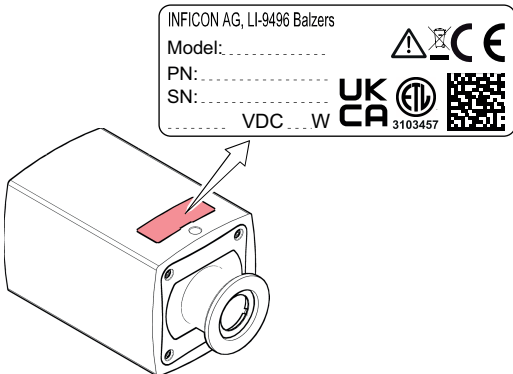

Validity

This document applies to products with part numbers

3	O	F	0	-	0	1	1	-	0	1	P
				Tube				Flange			
$\varnothing 1/2"$	0										
$\varnothing 1"$	1										
		1	DN 16 ISO-KF								
		3	DN 16 CF-R								
		6	DN 25 ISO-KF								
		7	DN 40 ISO-KF								
		E	8 VCR female								
		Q	DN 40 CF-F								

The part number (PN) can be taken from the product nameplate.

If not indicated otherwise in the legends, the illustrations in this document correspond to gauges with DN 25 ISO-KF vacuum connection. They apply to gauges with other vacuum connections by analogy.

Intended Use

The Optical Plasma Gauge OPG550 has been designed for

- an optical leak and residual gas detection, as well as a spectrum measurement of gases in the pressure range of 1×10^{-7} ... 5 mbar
- total pressure measurement of gases in the pressure range of 1×10^{-7} ... 1000 mbar.

It must not be used for measuring flammable or combustible gases in mixtures containing oxidants (e.g. atmospheric oxygen) within the explosion range.

Functional Principle

The gauge consists of a cold cathode system according to the inverted magnetron principle and a Pirani measuring system.

The cold cathode system is used to generate a plasma inside the gauge. The signal of the Pirani measuring system is used for the interlock function.

Trademarks

Augent™ INFICON Holding AG
VCR® Swagelok Marketing Co.

Scope of Delivery

- 1× gauge
- 1× Operating Manual

Inhaltsverzeichnis

Product Identification	2
Validity	2
Intended Use	3
Functional Principle	3
Trademarks	3
Scope of Delivery	3
1 Safety	6
1.1 Symbols Used.....	6
1.2 Personnel Qualifications	6
1.3 General Safety Instructions	7
1.4 Liability and Warranty	7
2 Technical Data.....	8
2.1 Measurement Ranges, Relationships (Analog Output).....	12
2.1.1 Measurement Signal vs. Total Pressure	13
2.1.2 Measurement Signal vs. Gas Partial Pressure.....	17
2.1.3 Measurement Signal vs. Wavelength Intensity	18
2.1.4 Measurement Signal vs. Augent Number.....	19
2.1.5 Measurement Signal vs. Pressure Rise	20
2.2 Gas Type Dependence Total Pressure	21
3 Installation	24
3.1 Vacuum Connection	24
3.2 Power Connection	26
3.2.1 D-sub, 9-pin Connector	28
4 Operation	29
4.1 Status Indication	29
4.2 Put Gauge Into Operation.....	30
4.2.1 Manual Mode (default)	31
4.2.2 Automatic Mode	31
4.3 Measurements and Measurement Types	32
4.3.1 Leak Detection (RoR – Rate of Rise).....	33
4.3.2 Spectrum (SPEC).....	33
4.3.3 Residual Gas Detektion (RGD)	34

4.4	Ignition Delay	35
4.5	Switching Functions	35
4.5.1	Switching Function – Total Pressure	38
4.5.2	Switching Function – Gas Partial Pressure	39
4.5.3	Switching Function – Wavelength Intensity	40
4.5.4	Switching Function – Augent Number	41
4.5.5	Switching Function – Pressure Rise	42
4.5.6	RGD Partial Pressure Alarm	43
5	Contamination	44
6	Application Examples	45
6.1	Leak Detection in Pressure Rise Measurement (RoR)	45
6.2	Residual Gas Detection (RGD)	48
7	Deinstallation	51
8	Maintenance, Repair	53
8.1	Troubleshooting (measuring chamber)	53
8.1.1	Replacing Measuring Chamber	56
8.2	Troubleshooting	57
9	Returning the Product	59
10	Disposal	60
11	Spare Parts	61
12	Accessories	61
	Further Information	61
	ETL Certification	62
	EU Declaration of Conformity	63
	UKCA Declaration of Conformity	64

Symbol for cross-references within this document:

→  XY

Symbol for references to literature list:

→  [Z]

1 Safety

1.1 Symbols Used



Information on preventing any kind of physical injury.



Information on preventing extensive equipment and environmental damage.



Information on correct handling or use. Disregard can lead to malfunctions or minor equipment damage.



Symbol printed on the product nameplate: Consultation of operating manual required



Notice



Labeling

1.2 Personnel Qualifications



All work described in this document may only be carried out by persons who have suitable technical training and the necessary experience or who have been instructed by the end-user of the product.

1.3 General Safety Instructions

- Adhere to the applicable regulations and take the necessary precautions for the process media used.

Consider possible reactions between the materials and the process media.

Consider possible reactions of the process media (e.g. explosion) due to the heat generated by the product (Pirani filament 120 °C).

- Adhere to the applicable regulations and take the necessary precautions for all work you are going to do and consider the safety instructions in this document.
- Before beginning to work, find out whether any vacuum components are contaminated. Adhere to the relevant regulations and take the necessary precautions when handling contaminated parts.

Communicate the safety instructions to all other users.

1.4 Liability and Warranty

INFICON assumes no liability and the warranty becomes null and void if the end-user or third parties

- disregard the information in this document
- use the product in a non-conforming manner
- make any kind of interventions (modifications, alterations etc.) on the product
- use the product with accessories not listed in the corresponding product documentation.

The end-user assumes the responsibility in conjunction with the process media used.

Gauge failures due to contamination or wear and tear, as well as expendable parts (e.g. Pirani filament), are not covered by the warranty.

2 Technical Data

Measurement range (N₂)

Gas detection	1×10 ⁻⁷ ... 5 mbar
Total pressure measurement	1×10 ⁻⁷ ... 1000 mbar

Detection limit (H₂)

O ₂ leak in pressure rise method	≥0.3 mTorr/min
O ₂ leak during pump down (backfill with N ₂)	≥1 mTorr/min

Total pressure

Accuracy (N₂)



1×10 ⁻⁷ ... 100 mbar	30% of reading
100 ... 1000 mbar	50% of reading

Repeatability (N₂)

1×10 ⁻⁷ ... 100 mbar	5% of reading
---------------------------------	---------------

Output signal (measurement signal)

Analog	0 ... +10 V (dc)
Digital	RS232

Measurement ranges, relationships (analog output) →  13 ... →  20



Output impedance 2 × 4.7 Ω, short-circuit proof

Load impedance >10 kΩ, short-circuit proof

Step response time

>1×10 ⁻⁶ mbar	<100 ms
1×10 ⁻⁶ ... 1×10 ⁻⁷ mbar	≈1 s

Supply

	 DANGER
<p>The gauge may only be connected to power supplies, instruments or control devices that conform to the requirements of a grounded protective extra-low voltage and limited power source (LPS), Class 2. The connection to the gauge has to be fused.</p>	

Supply voltage at the gauge ¹⁾	Class 2 / LPS +14.5 ... +30 V (dc)
Ripple	≤1 V _{pp}
Power consumption	≤5 W
Fuse to be connected	1 AT
<hr/>	
High voltage in the measuring chamber	
Ignition voltage	≤4.5 kV
Operating voltage	≤3.3 kV
<hr/>	
Current in the measuring chamber	low current
<hr/>	
Electrical connection	D-sub 9-pin, male
Sensor cable	9-pin plus shielding
<hr/>	
Grounding concept	→  26
Vacuum connection – signal common	connected via 10 kΩ (potential difference ≤16 V)
Supply common – signal common	conducted separately; differential measurement is recommended
<hr/>	
Materials exposed to vacuum	
General	ceramics Al ₂ O ₃ , stainless steel 1.4435
Anode	molybdenum

¹⁾ The minimum voltage of the power supply unit must be increased proportionally to the length of the sensor cable.

Ionization chamber	Ti, stainless steel 1.4016
Ignition aid	stainless steel 1.4310
Pirani filament	W, Al ₂ O ₃ coated
Internal volume	≤46 cm ³
Permissible pressure (absolute)	10 bar limited to inert gases <55 °C
Bursting pressure (absolute)	>13 bar
<hr/>	
Permissible temperatures	
Operation	+5 °C ... +50 °C
Pirani filament	120 °C
Bakeout	
with electronics	≤80 °C at flange
without electronics	≤120 °C at flange
Storage	-20 °C ... +70 °C
Relative humidity, year's mean during 30 days a year	
1×10 ⁻⁸ ... 1×10 ⁻² mbar	≤70% (non-condensing)
1×10 ⁻⁷ ... 1×10 ⁻² mbar	≤95% (non-condensing)
Mounting orientation	any
Use	indoors only, altitude up to 6000 m
Pollution degree	2
Degree of protection	IP 40
<hr/>	
Weight	≤800 g
<hr/>	

Dimensions [mm (inch)]

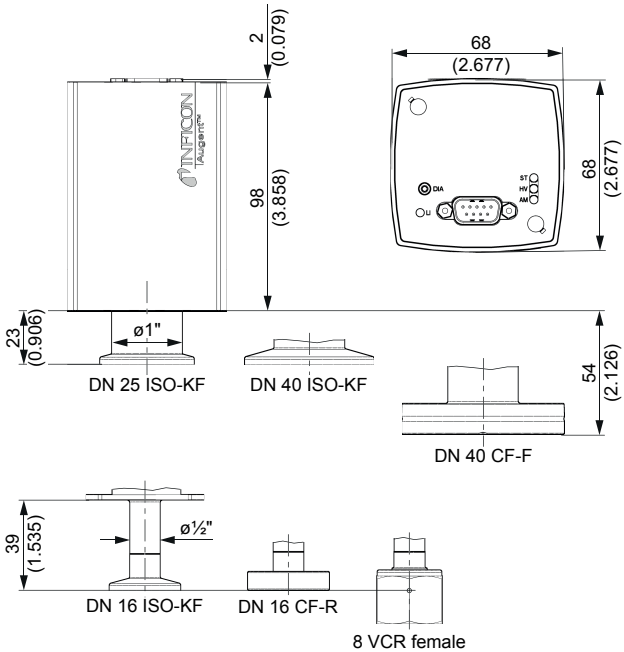

2.1 Measurement Ranges, Relationships (Analog Output)

The analog measuring signal can be programmed via the RS232 interface (Communication Protocol → [\[1\]](#)).

Programmable modes:

- Total pressure
 - Measurement range 1.5 ... 8.5 V (type N) (→ [\[13\]](#))
 - Measurement range 0.667 ... 10 V (type Q) (→ [\[14\]](#))
 - Measurement range 1.397 ... 8.6 V (type P, default) (→ [\[15\]](#))
 - Measurement range 0.75 ... 10 V (type H) (→ [\[16\]](#))
- Gas partial pressure (→ [\[17\]](#))
- Wavelength intensity (→ [\[18\]](#))
- Augent number (→ [\[19\]](#))
- Pressure rise (→ [\[20\]](#))
- Switching function Total Pressure (→ [\[38\]](#))
- Switching function Gas Partial Pressure (→ [\[39\]](#))
- Switching function Wavelength Intensity (→ [\[40\]](#))
- Switching function Augent Number (→ [\[41\]](#))
- Switching function Pressure Rise (→ [\[42\]](#))
- Partial Pressure Alarm (→ [\[43\]](#))

2.1.1 Measurement Signal vs. Total Pressure

Measurement range 1.5 ... 8.5 V (type N)

Pressure [p]

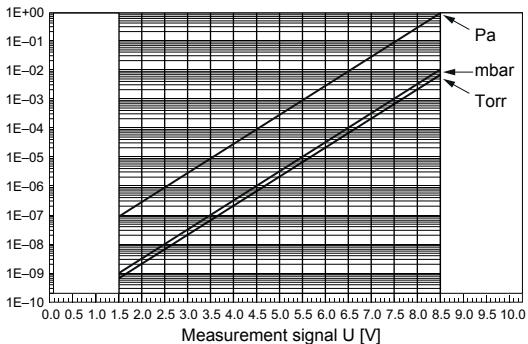

Formula: $p = 10^{U-c} \Leftrightarrow U = c + \log_{10} p$

Valid in the range: $1 \times 10^{-9} \text{ mbar} < p < 1 \times 10^{-2} \text{ mbar}$
 $7.5 \times 10^{-10} \text{ Torr} < p < 7.5 \times 10^{-3} \text{ Torr}$
 $1 \times 10^{-7} \text{ Pa} < p < 1 \text{ Pa}$

	mbar	Pa	Torr
c	10.5	8.5	10.625

where

- p pressure
- U measurement signal
- c constant (pressure unit dependent)

Measurement range 0.667 ... 10 V (type Q)

Pressure [p]

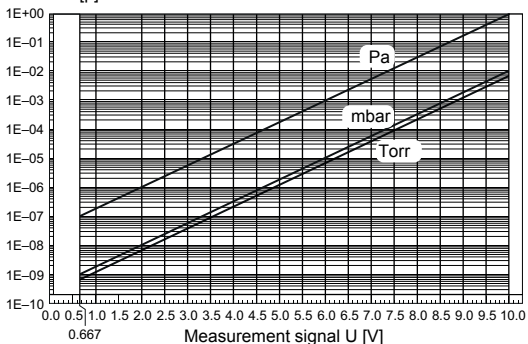

$$\text{Formula: } p = 10^{(U-c)/1.33} \Leftrightarrow U = c + 1.33 \log_{10} p$$

Valid in the range: $1 \times 10^{-9} \text{ mbar} < p < 1 \times 10^{-2} \text{ mbar}$
 $7.5 \times 10^{-10} \text{ Torr} < p < 7.5 \times 10^{-3} \text{ Torr}$
 $1 \times 10^{-7} \text{ Pa} < p < 1 \text{ Pa}$

	mbar	Pa	Torr
c	12.66	10	12.826

where

- p pressure
- U measurement signal
- c constant (pressure unit dependent)

Measurement range 1.397 ... 8.6 V (type P, default)

Pressure [p]

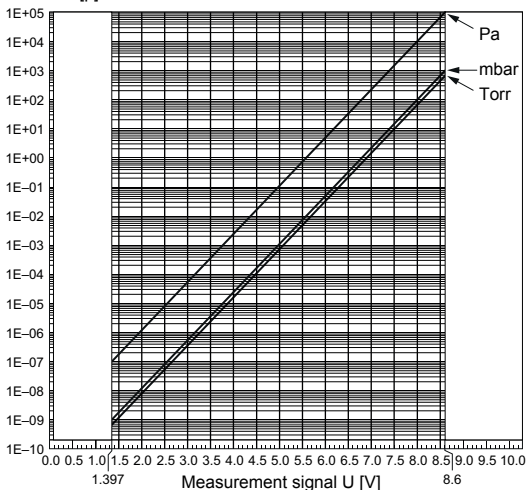

$$\text{Formula: } p = 10^{1.667U-d} \Leftrightarrow U = c + 0.6 \log_{10} p$$

Valid in the range: $1 \times 10^{-9} \text{ mbar} < p < 1000 \text{ mbar}$
 $7.5 \times 10^{-10} \text{ Torr} < p < 750 \text{ Torr}$
 $1 \times 10^{-7} \text{ Pa} < p < 1 \times 10^5 \text{ Pa}$

	mbar	Pa	Torr
c	6.798	5.598	6.873
d	11.33	9.333	11.46

where
 p pressure
 U measurement signal
 c,d constant (pressure unit dependent)

Measurement range 0.75 ... 10 V (type H)

Pressure [p]

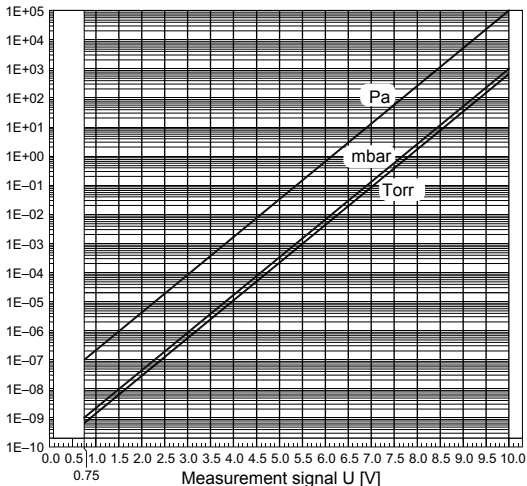

$$\text{Formula: } p = 10^{(U-0.75)/0.75+c} \Leftrightarrow U = 0.75 (\log_{10} p - c) + 7.75$$

Valid in the range: $1 \times 10^{-10} \text{ mbar} < p < 1000 \text{ mbar}$
 $7.5 \times 10^{-11} \text{ Torr} < p < 750 \text{ Torr}$
 $1 \times 10^{-8} \text{ Pa} < p < 1 \times 10^5 \text{ Pa}$

	mbar	Pa	Torr
c	0	2	-0.125

where

- p pressure
- U measurement signal
- c constant (pressure unit dependent)

2.1.2 Measurement Signal vs. Gas Partial Pressure

Measurement range 1 ... 9 V, valid for measurement type RGD

Pressure [p]

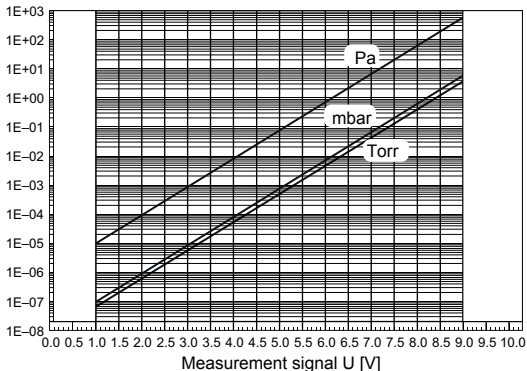

$$\text{Formula: } p = 10^{(U-c)/1.039} \Leftrightarrow U = c + 1.039 \log_{10} p$$

Valid in the range: $1 \times 10^{-7} \text{ mbar} < p < 5 \text{ mbar}$
 $7.5 \times 10^{-8} \text{ Torr} < p < 3.75 \text{ Torr}$
 $1 \times 10^{-5} \text{ Pa} < p < 5 \times 10^{-2} \text{ Pa}$

	mbar	Pa	Torr
c	8.273	6.195	8.403

where

- p pressure
- U measurement signal
- c constant (pressure unit dependent)

2.1.3 Measurement Signal vs. Wavelength Intensity

Measurement range 0 ... 10 V, valid for measurement types RGD, SPEC

Measurement signal U [V]

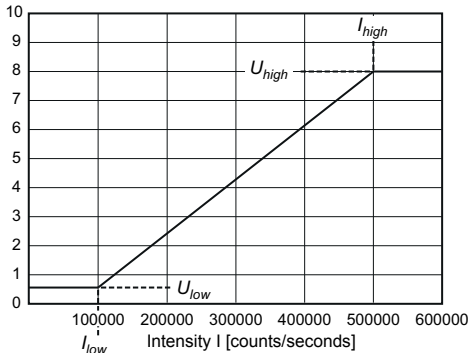

$$U[V] = m I[\text{counts/s}] + n \quad \Leftrightarrow \quad I[\text{counts/s}] = (U[V] - n) / m$$

$$m = \frac{U_{high} - U_{low}}{I_{high} - I_{low}}$$

$$n = U_{low} - m \times I_{low}$$

where

I	intensity of the selected wavelength
U	measurement signal
U _{low}	constant (minimum voltage level)
U _{high}	constant (maximum voltage level)
I _{low}	constant (minimum intensity)
I _{high}	constant (maximum intensity)

2.1.4 Measurement Signal vs. Augent Number

Measurement range 0 ... 10 V, valid for measurement type RoR

Measurement signal U [V]

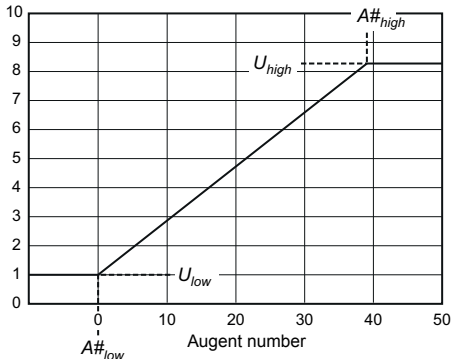

$$U[V] = m A\# + n \quad \Leftrightarrow \quad A\# = (U[V] - n) / m$$

$$m = \frac{U_{high} - U_{low}}{A\#_{high} - A\#_{low}}$$

$$n = U_{low} - m \times A\#_{low}$$

where

$A\#$	Augent number
U	measurement signal
U_{low}	constant (minimum voltage level)
U_{high}	constant (maximum voltage level)
$A\#_{low}$	constant (switching function 1)
$A\#_{high}$	constant (switching function 2)

2.1.5 Measurement Signal vs. Pressure Rise

Measurement range 0 ... 10 V, valid for measurement type RoR

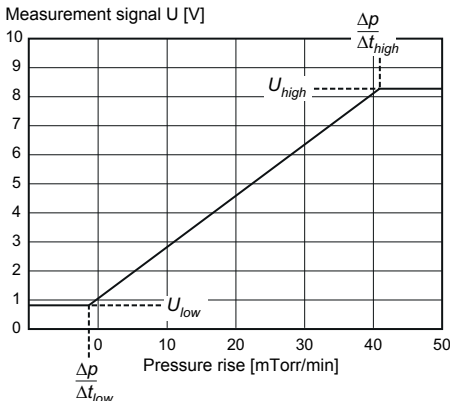

$$U[V] = m \frac{\Delta p}{\Delta t[\text{mTorr/min}]} + n \quad \Leftrightarrow \quad \frac{\Delta p}{\Delta t}[\text{mTorr/min}] = \frac{U[V] - n}{m}$$

$$m = \frac{U_{\text{high}} - U_{\text{low}}}{\frac{\Delta p}{\Delta t}_{\text{high}} - \frac{\Delta p}{\Delta t}_{\text{low}}}$$

$$n = U_{\text{low}} - m \times \frac{\Delta p}{\Delta t}_{\text{low}}$$

where

$\Delta p/\Delta t$	pressure rise (mTorr/min)
U	measurement signal
U_{low}	constant (minimum voltage level)
U_{high}	constant (maximum voltage level)
$\Delta p/\Delta t_{\text{low}}$	constant (switching function 1)
$\Delta p/\Delta t_{\text{high}}$	constant (switching function 2)

2.2 Gas Type Dependence Total Pressure

Measurement range from 10^2 ... 10^{-2} mbar (Pirani-only operation)

Indicated pressure (gauge calibrated for air)

p [mbar]

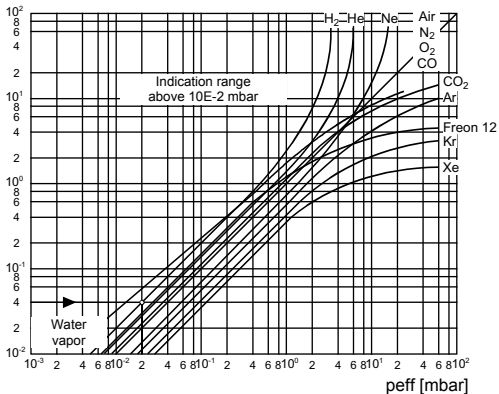

Measurement range from 10^{-6} ... 0.1 mbar

Indicated pressure (gauge calibrated for air)

p [mbar]

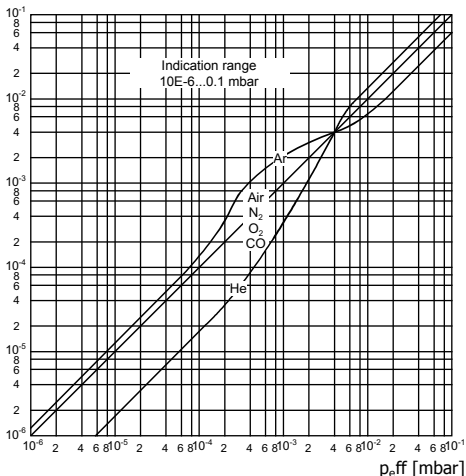

Measurement range below 10^{-5} mbar

In the range below 10^{-5} mbar the pressure indication is linear. For gases other than air, the pressure can be determined by means of a simple conversion formula:



$$p_{\text{eff}} = K \times \text{indicated pressure}$$

Correction factors (K):

Gas type	K
Air (N ₂ , O ₂ , CO)	1.0
Xe	0.4
Kr	0.5
Ar	0.8
H ₂	2.4
Ne	4.1
He	5.9

These conversion factors are average values.



A mixture of gases and vapors is often involved. In this case, accurate determination is possible with a partial pressure measurement of the RGD measurement type (→  34, →  48).

3 Installation



DANGER



Leaking process media
High-intensity mechanical, chemical or thermal impacts can cause leaks in the measuring sensor. Process media can thus leak and possibly cause hazards, if overpressure is in the vacuum system.

- Avoid high-intensity mechanical, chemical or thermal impacts and overpressure in the vacuum system.
- Take appropriate measures (e.g. shut off gas supply, extraction, leak test) to avoid hazards or damage due to leaking process media.

3.1 Vacuum Connection



DANGER



Overpressure in the vacuum system >1 bar
Injury caused by released parts and harm caused by escaping process gases can result if clamps are opened while the vacuum system is pressurized.

- Do not open any clamps while the vacuum system is pressurized. Use the type of clamps which are suited to overpressure.

DANGER



Overpressure in the vacuum system >2.5 bar
KF flange connections with elastomer seals (e.g. O-rings) cannot withstand such pressures. Process media can thus leak and possibly damage your health.

- Use O-rings provided with an outer centering ring.

**DANGER****Protective ground**

The gauge must be electrically connected to the grounded vacuum chamber. This connection must conform to the requirements of a protective connection according to EN 61010:

- CF and VCR connections fulfill this requirement.
- For gauges with a KF vacuum connection, use a conductive metallic clamping ring.
- For gauges with a 1/2" tube, take appropriate measures to fulfill this requirement.

**Caution****Vacuum component**

Dirt and damages impair the function of the vacuum component.

- When handling vacuum components, take appropriate measures to ensure cleanliness and prevent damages.

**Caution****Dirt sensitive area**

Touching the product or parts thereof with bare hands increases the desorption rate.

- Always wear clean, lint-free gloves and use clean tools when working in this area.



Mount the gauge so that no vibrations occur. Vibrations at the gauge cause a deviation of the measured values.

The gauge may be mounted in any orientation. To keep condensates and particles from getting into the measuring chamber preferably choose a horizontal to upright position.

Remove the protective lid and connect the product to the vacuum system.

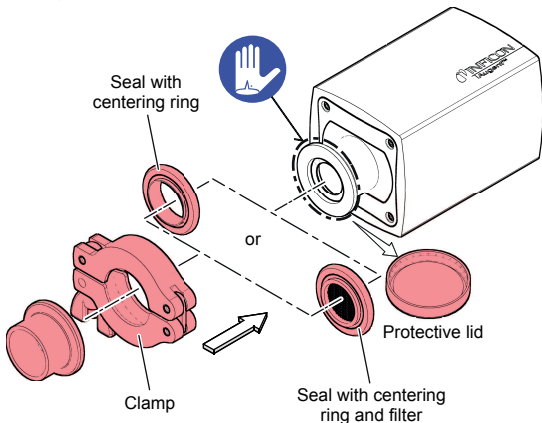

Keep the protective lid.

3.2 Power Connection



Make sure the vacuum connection is properly made.



DANGER



The gauge may only be connected to power supplies, instruments or control devices that conform to the requirements of a grounded protective extra-low voltage and limited power source (LPS), Class 2. The connection to the gauge has to be fused.



Ground loops, differences of potential, or EMC problems may affect the measurement signal. For optimum signal quality, please do observe the following notes:

- Use an overall metal braided shielded cable. The connector must have a metal case.
- Connect the supply common with protective ground directly at the power.
- Use differential measurement input (signal common and supply common conducted separately).
- Potential difference between supply common and housing ≤ 6 V (overvoltage protection).

3.2.1 D-sub, 9-pin Connector

If no sensor cable is available, make one according to the following diagram. Connect the sensor cable.

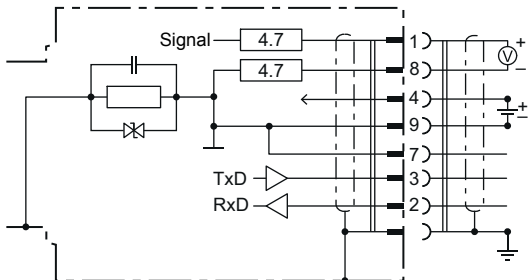

- Pin 1 Signal output (measuring signal)
- Pin 2 RS232, RxD
- Pin 3 RS232, TxD
- Pin 4 Supply (+14.5 ... +30 V (dc))
- Pin 5 n.c.
- Pin 6 n.c.
- Pin 7 RS232, GND
- Pin 8 Signal common
- Pin 9 Speisungserde

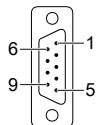

D-sub, 9-pin
female
soldering side

4 Operation

4.1 Status Indication

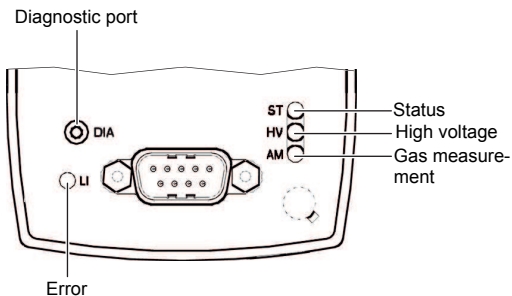

LED	Color	Status	Meaning
ST	green	off	No supply voltage
		single flash	Gauge is put into operation
		double flash	Gauge in boot mode
HV	green	lit solid	Supply voltage ok
		off	High voltage and plasma OFF
		blinking	High voltage ON, plasma OFF
AM	blue	lit solid	High voltage and plasma ON
		off	No gas detection
		lit solid	Gas detection active

LED	Color	Status	Meaning
LI	green	lit solid	Gauge ok
	orange	lit solid	Gauge ok, Service is imminent
	red	lit solid	Service required, Gas detection no longer valid
		single flash	Internal error, not functional
	double flash	Error: Firmware not valid	
	triple flash	Contact error to sensor cell	

4.2 Put Gauge Into Operation

The gauge can be operated in two modes:

- Manual Mode via the RS232 interface (default)
- Automatic Mode (programmable via the RS232 interface → [\[1\]](#)).

Measurement principle, measuring behavior

The gauge consists of a cold cathode system according to the inverted magnetron principle and a Pirani measuring system.

The cold cathode system generates a plasma inside the gauge. The emitted light of the plasma is measured and analyzed by means of an optical system (measurement types → [\[32\]](#), application examples → [\[45\]](#)).

The cold cathode measurement signal is active when the plasma is switched on. When the plasma is switched off, the Pirani measurement signal is output.

The Pirani measuring circuit is always on and also controls the on/off switching of the plasma (interlock function).

4.2.1 Manual Mode (default)

When the supply voltage is applied, put the gauge into operation via the RS232C interface (Communication Protocol →  [1]).

Allow for a stabilizing time of approx. 10 min. Once the gauge has been put into operation, it can remain in operation permanently irrespective of the pressure.

Plasma on / off mode

The plasma can be switched on and off:

- Manually via the RS232 interface
- Automatic by start / stop of a measurement

By starting / stopping a measurement, the plasma is automatically switched on and off. This power-on mode extends the service life of the OPG550.

If the plasma was switched on manually via the RS232 interface before starting a measurement, it remains active even after a measurement has been stopped and must be switched off again manually via the interface.

- Automatically by the interlock function (only switch off)

The plasma is automatically switched off above a pressure of 20 mbar (default). This prevents excessive contamination.

Switch plasma on again:

- restart measurement, or
- manually via the RS232 interface.

The interlock function can be activated / deactivated via the RS232 interface.

4.2.2 Automatic Mode

The Automatic Mode and the respective measuring type can be programmed via the RS232 interface (→  [1]).

After applying the supply voltage, the measurement signal of the selected measurement type is available at the signal output as soon as the plasma is automatically switched on at a pressure <20 mbar (default).

Allow for a stabilizing time of approx. 10 min. Once the gauge has been put into operation, it can remain in operation permanently irrespective of the pressure.

Programmable measurement types

The following measurement types can be programmed in Automatic Mode:

- Spectrum measurement (SPEC)
- Leak detection (RoR - Rate of Rise)
- Residual Gas Detection (RGD)

Plasma on / off mode

If the pressure in the vacuum chamber is <20 mbar (default), the plasma is switched on automatically. Above a pressure of 20 mbar, the plasma is automatically switched off. This prevents excessive contamination. The threshold value for switching the plasma on/off (20 mbar default) can be programmed via the RS232 interface (→  [1]).

4.3 Measurements and Measurement Types

The gauge allows the operation of three types of measurement:

- Spectrum measurement (SPEC)
- Leak detection (RoR - Rate of Rise)
- Residual Gas Detection (RGD)

Only one measurement type can be processed at a time.

Differences between the measurement types:

Measur. type	Integration time	Background Compens.	Spectra Data	Result
RoR	aut.	-	counts	Leak rate Spectrum
RGD	aut.	yes	counts/s	Residual gases Spectrum
SPEC	man.	yes	counts/s	Spectrum

4.3.1 Leak Detection (RoR – Rate of Rise)

The RoR measurement type measures the effective gas emission spectrum and characterizes the outgassing behavior of a vacuum chamber during a pressure rise measurement.

The analysis of the gas emission spectrum is used to detect small leaks. Large leaks are detected by means of the pressure signal, taking into account the data from the beginning of the measurement until the current time.

The integration time of the measurement is set automatically and allows the specification of a gas type. From the measured data normalized gradients of the gas emission lines are calculated and output as Augent numbers. The data from the beginning of the measurement up to the current time are considered.

As input for the automatically controlled integration time the gas type can be specified. The integration time is set so that either the measurement is sensitive to the entire spectrum or the signal-to-noise ratio is optimal for the respective gas emission line.

4.3.2 Spectrum (SPEC)

The SPEC measuring type measures the gas emission spectrum with a manually set integration time.

At the beginning of the measurement, the background spectrum is automatically recorded and then subtracted from the measured spectrum.

As input the desired integration time in milliseconds is given. The integration time is constant during the whole measurement. If the integration time is changed, the measurement must be restarted.

The unit of measurement data "counts/s" is standardized to the integration time. The measurement data therefore contain all information of the plasma source.

4.3.3 Residual Gas Detektion (RGD)

The RGD measuring type measures a signal-to-noise optimized gas emission spectrum and detects gas types, detects gas types and measures gas partial pressures.

If the integration time is automatically adjusted, the background spectrum is automatically recorded and then subtracted from the measured spectrum.

The gas spectrum is measured with two different integration times.

The first measurement is performed with a short, automatically calculated integration time. This measurement is sensitive to the whole spectrum.

The second measurement is performed with a longer integration time to increase the signal-to-noise ratio of the less intensive emission lines.

With the gas type "0 - Sensitive to whole spectrum" the second integration time is 8 times the first integration time. When selecting a specific gas, the second integration time is specifically set to the emission line of that gas.

The two spectra are added together to form a complete spectrum. The unit of the measured data "counts/sec" is standardized to the integration time. The measurement data thus contain all information of the plasma source.

The RGD measuring type analyzes the entire spectrum and tests gases such as hydrogen, helium, nitrogen, oxygen and argon.

The gas partial pressure is calculated from the information of the detected gases and the measured total pressure.

4.4 Ignition Delay

An ignition delay occurs when cold cathode gauges are switched on. The delay time increases at low pressures and for clean, degassed gauges it is typically:

$1 \times 10^{-5} \dots 10 \text{ mbar}$ <1 second

$1 \times 10^{-7} \dots 1 \times 10^{-5} \text{ mbar}$ <20 seconds

The ignition is a statistical process. Already a small amount of depositions on the inner surfaces can have a strong influence on it.

As long as the plasma in the cold cathode system has not ignited, no gas measurement can be performed.



If the high voltage is switched on at a pressure $p < 3 \times 10^{-9} \text{ mbar}$, the gauge cannot detect whether the cold cathode system has ignited.

4.5 Switching Functions

The analog measurement signal can be programmed for switching functions (set points SP1 and SP2) via the RS232 interface (Communication Protocol → [1]).

The two switching functions can be set to any pressure within the measurement range of the gauge.

Programmable switching functions:

- Switching function Total Pressure (→ 38)
- Switching function Gas Partial Pressure (→ 39)
- Switching function Wavelength Intensity (→ 40)
- Switching function Augent Number (→ 41)
- Switching function Pressure Rise (→ 42)
- RGD Partial Pressure Alarm (→ 43)

Switching characteristics, hysteresis, voltage level

The switching characteristics and the hysteresis of each set point can be programmed.

Additionally the voltage levels U_{high} and U_{low} can be set to any voltage within the voltage range of the gauge (0 ... 10 V). The mean voltage U_{center} is calculated automatically from the set U_{high} and U_{low} .

The following describes the function of the switching functions in the switching function mode Total Pressure. It applies to the other switching function modes by analogy.

High Trip Point

If the total pressure in the vacuum system is higher than the set threshold value p_{high} , the set voltage U_{high} (10 V) is output at the analog output in Normal mode and the set voltage U_{low} (0 V) in Inverted mode.

Low Trip Point

If the total pressure in the vacuum system is lower than the set threshold value p_{low} , the set voltage U_{low} (0 V) is output at the analog output in Normal mode and the set voltage U_{high} (10 V) in Inverted mode.

If the total pressure in the vacuum system is within the set switching points ($p_{\text{low}} < p < p_{\text{high}}$), the automatically calculated mean voltage U_{center} (5 V) is output at the analog output in Normal and Inverted mode.

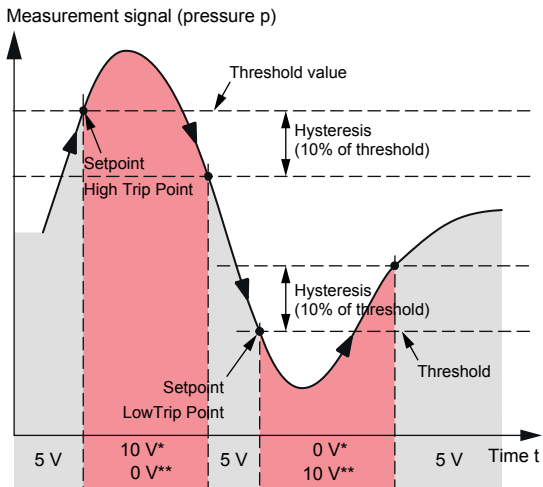

* Normal mode

** Inverted mode

4.5.1 Switching Function – Total Pressure

Measurement signal U [V]

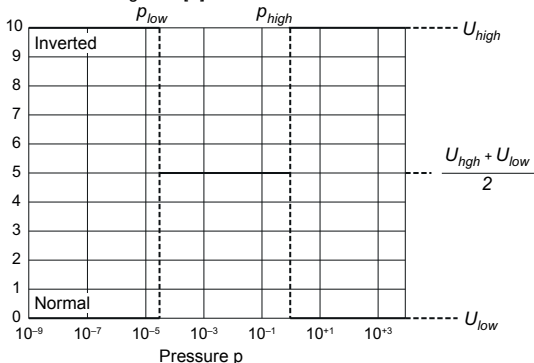

Condition		Orig.	Invert.
p_{low}	$> p$	U_{low}	U_{high}
p_{low}	$< p < p_{high}$	U_{center}	U_{center}
	$p > p_{high}$	U_{high}	U_{low}

where

- p total pressure
- U measurement signal
- U_{low} constant (minimum voltage level)
- U_{high} constant (maximum voltage level)
- p_{low} constant (setpoint 1 - total pressure)
- p_{high} constant (setpoint 2 - total pressure)

4.5.2 Switching Function – Gas Partial Pressure

Valid for measurement type RGD

Measurement signal U [V]

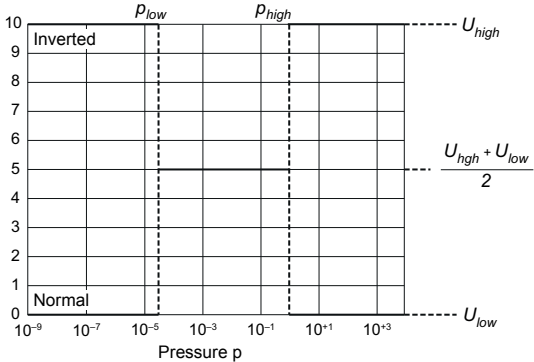

Condition		Orig.	Invert.
p_{low}	$> p$	U_{low}	U_{high}
p_{low}	$< p < p_{high}$	U_{center}	U_{center}
	$p > p_{high}$	U_{high}	U_{low}

where

- p partial pressure
- U measurement signal
- U_{low} constant (minimum voltage level)
- U_{high} constant (maximum voltage level)
- p_{low} constant (setpoint 1 – partial pressure)
- p_{high} constant (setpoint 2 – partial pressure)

4.5.3 Switching Function – Wavelength Intensity

Valid for measurement types RGD and SPEC

Measurement signal U [V]

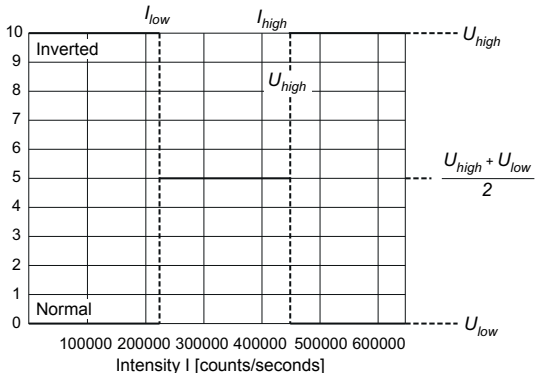

Condition		Orig.	Invert.
I_{low}	$> I$	U_{low}	U_{high}
I_{low}	$< I < I_{high}$	U_{center}	U_{center}
	$I > I_{high}$	U_{high}	U_{low}

where

- I intensity
- U measurement signal
- U_{low} constant (minimum voltage level)
- U_{high} constant (maximum voltage level)
- I_{low} constant (setpoint 1 - intensity)
- I_{high} constant (setpoint 2 - intensity)

4.5.4 Switching Function – Augent Number

Valid for measurement type RoR

Measurement signal U [V]

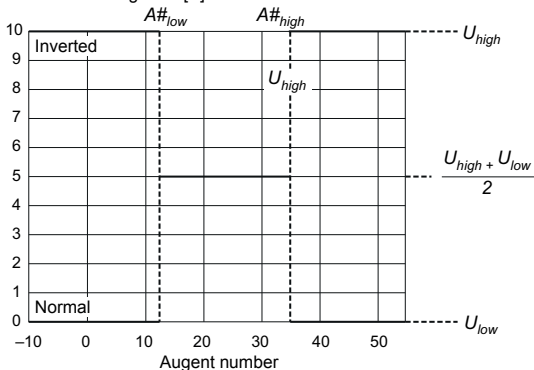

Condition			Orig.	Invert.
$A\#_{low}$	$> A\#$		U_{low}	U_{high}
$A\#_{low}$	$< A\# <$	$A\#_{high}$	U_{center}	U_{center}
	$A\# >$	$A\#_{high}$	U_{high}	U_{low}

where

- $A\#$ Augent number (normalized gas emission gradient)
- U measurement signal
- U_{low} constant (minimum voltage level)
- U_{high} constant (maximum voltage level)
- $A\#_{low}$ constant (setpoint 1)
- $A\#_{high}$ constant (setpoint 2)

4.5.5 Switching Function – Pressure Rise

Valid for measurement type RoR

Measurement signal U [V]

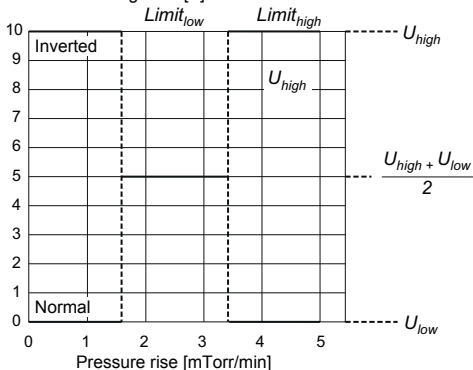

Condition		Orig.	Invert.
Limit _{low}	> Δp/Δt	U _{low}	U _{high}
Limit _{low}	< Δp/Δt < Limit _{high}	U _{center}	U _{center}
	Δp/Δt > Limit _{high}	U _{high}	U _{low}

where

- Δp/Δt pressure rise value [mTorr/min]
- U measurement signal
- U_{low} constant (minimum voltage level)
- U_{high} constant (maximum voltage level)
- Limit_{low} constant (setpoint 1)
- Limit_{high} constant (setpoint 2)

4.5.6 RGD Partial Pressure Alarm

Set: Set Analog Output to the mode <RGD Partial Pressure Alarm>.

Get: Get the corresponding parameters of the mode <RGD Partial Pressure Alarm>.

The analog output is used for two different functionalities.

- The range from 0 ... 5 V is used as analog output dependent on partial pressure of a specific gas.

$$\text{Formula: } p = 10^{(U-4.5/0.5)} \Leftrightarrow U = 4.5 + 0.5 \log_{10} p$$

where p pressure [mbar]
 U measurement signal [V]

- The range from 6 ... 10 V is used for 5 alarms. Jeder Each alarm can be assigned to a specific gas partial pressure or to the total pressure. An alarm can be configured as an upper or a lower trip point (mode). If the partial pressure of the specified gas is above / below the defined trip point, the analog output is set to the alarm specific voltage. Alarm 1 corresponds to 6.0 V, alarm 2 to 7.0 V and so on. Whether an alarm is issued at the output also depends on the number of fulfilled alarm conditions. The minim number can be defined via the parameter <Number of Alarms that must be active>.

Alarm priorities

Alarm 1 (at 6 V) has the highest priority and alarm 5 the lowest. If more than one alarm is active, the one with the higher priority is set on the analog output.

Alarm update time

The alarm update time depends on the execution time of the <Residual Gas Detection (RGD)> algorithm. If the algorithm is not active, alarm conditions are not checked.

5 Contamination



Gauge failures due to contamination or wear and tear, as well as expendable parts (e. g. Pirani filament), are not covered by the warranty.

Gauge contamination is influenced by the process media used as well as any existing or new contaminants and their respective partial pressures. Contamination of the gauge generally causes a deviation of the measured values.

An internal contamination protection ensures a longer lifetime of the OPG550.

The degree of contamination can be influenced to a limited extent by a specific selection of the gauge flange position at a location where the partial pressure of the contamination is minimal.

Special precautions are required for vapors deposited in the plasma (of the cold cathode measuring system). If necessary, switch off the gauge while the vapors are present or seal it off with a valve.

6 Application Examples

6.1 Leak Detection in Pressure Rise Measurement (RoR)

The OPG550 allows a fast and accurate leak detection during a pressure rise measurement. The leak gas can be air or other purge gas.

Pump the vacuum system to a pressure $p < 1$ Torr and close all valves. At this point start the "Rate of Rise Leak Detection" measurement type. Select the gas to be tested as input for the measurement type, for example "Oxygen O₂ 777 nm". The measurement type then calculates the normalized slope of the gas emission lines, the so-called Augent numbers.

An air leak leads to a constant increase in the intensity of the emission lines of nitrogen and oxygen during the pressure rise measurement. The following figure shows the time course of the intensity of the oxygen emission line for different leak rates.

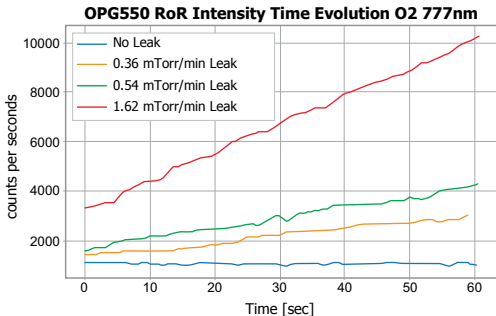

Relationship leak rate vs. Augent number

The normalized slope of the gas emission lines during a pressure rise measurement (Augent number) shows an almost linear behaviour to the leak rate of the vacuum system.

**Leak Detection RoR in Helium - pressure 90 mTorr
Leak Rate vs. Augent Number O2 777nm**

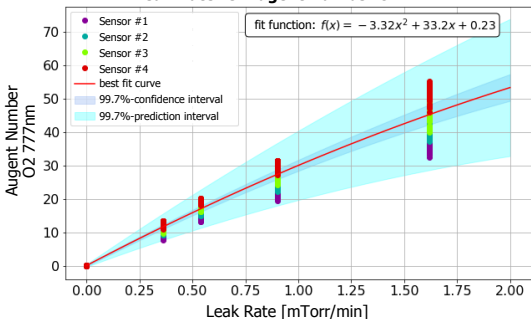

Pressure dependency

The following figure shows the pressure dependence of the Augent number or sensitivity for oxygen testing in the carrier gas helium. The initial pressure of the pressure rise measurement is noted on the X-axis. The leak rates used here are 0.36 mTorr/min, 0.54 mTorr/min, 0.90 mTorr/min and 1.62 mTorr/min. The vacuum system has a volume of 25 liters.

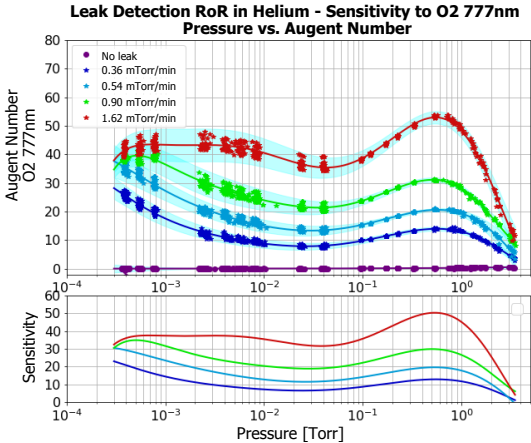

Time dependency

The following figure shows the time dependence of the Augent number and the noise behaviour for oxygen testing in the carrier gas helium.

Thus, the OPG550 sensor provides a clear leak detection after only 10 seconds of pressure rise measurement. The noise of the Augent numbers is $\pm 15\%$ at 10 seconds and less than $\pm 5\%$ after 30 seconds.

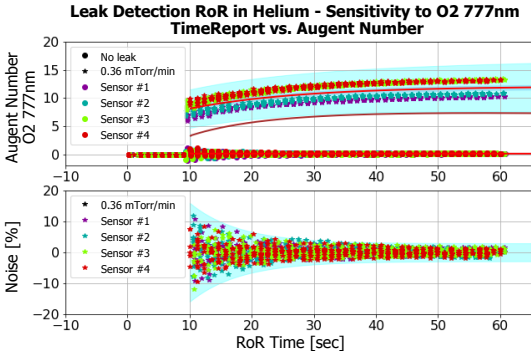

6.2 Residual Gas Detection (RGD)

In the pressure range of $1 \times 10^{-7} \dots 5$ mbar the OPG550 sensor allows gas testing and partial pressure measurement of various gases.

The intelligent "Residual Gas Detection" algorithm (RGD) provides a signal-to-noise optimized spectrum for both the intensive and the less intensive gas emission lines.

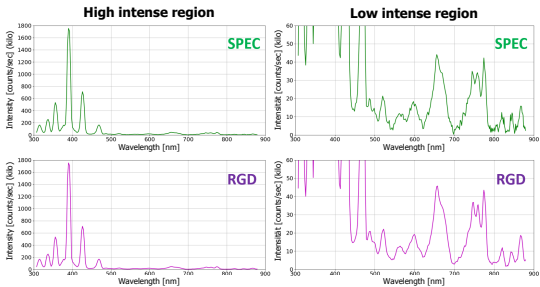

The optimized gas spectrum allows the precise testing of existing gases in the vacuum system and the measurement of gas partial pressures. For example, the OPG550 sensor allows the "golden state" of the vacuum system to be checked and impurities >10 ppm to be tested (detection limit dependent on gas type and pressure).

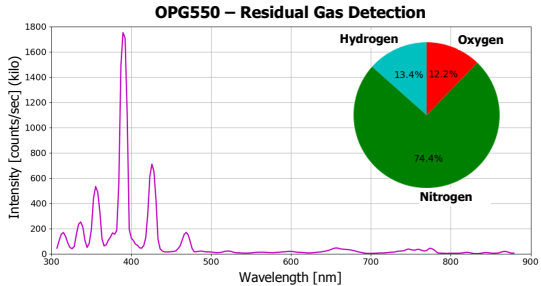

The figure below shows the absolute gas intensity of OH and nitrogen during a pump down procedure of a vacuum system with moist components. The gas intensity of OH, originating from residual water molecules, clearly indicates the moisture present and drops significantly as soon as the valve to the moist components is closed after approximately 195 seconds.

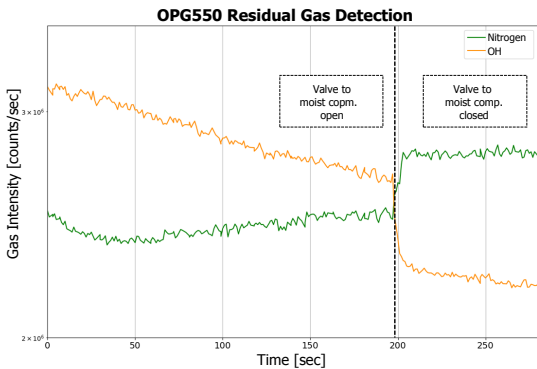

7 Deinstallation



DANGER



Contaminated parts

Contaminated parts can be detrimental to health and environment.

- Before beginning to work, find out whether any parts are contaminated. Adhere to the relevant regulations and take the necessary precautions when handling contaminated parts.



Caution



Vacuum component

Dirt and damages impair the function of the vacuum component.

- When handling vacuum components, take appropriate measures to ensure cleanliness and prevent damages.



Caution



Dirt sensitive area

Touching the product or parts thereof with bare hands increases the desorption rate.

- Always wear clean, lint-free gloves and use clean tools when working in this area.

- 1 Vent the vacuum system.
- 2 Put the gauge out of operation and disconnect the sensor cable.
- 3 Remove the gauge from the vacuum system and install the protective lid.

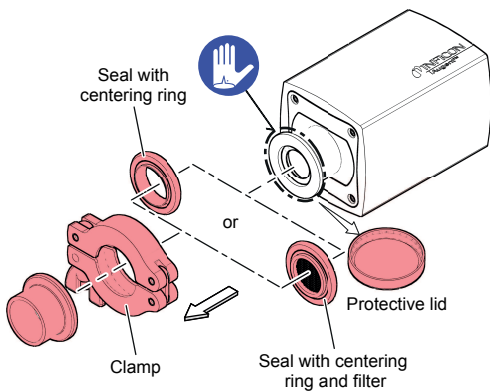

8 Maintenance, Repair



Gauge failures due to contamination or wear and tear, as well as expendable parts (e. g. Pirani filament), are not covered by the warranty.

INFICON assumes no liability and the warranty becomes null and void if any repair work is carried out by the end-user or third parties.

8.1 Troubleshooting (measuring chamber)



In case of severe contamination or defective (e.g. Pirani filament rupture), replace the measuring chamber.



STOP DANGER



Contaminated parts

Contaminated parts can be detrimental to health and environment.

- Before beginning to work, find out whether any parts are contaminated. Adhere to the relevant regulations and take the necessary precautions when handling contaminated parts.



Caution



Vacuum component

Dirt and damages impair the function of the vacuum component.

- When handling vacuum components, take appropriate measures to ensure cleanliness and prevent damages.

**Caution****Dirt sensitive area**

Touching the product or parts thereof with bare hands increases the desorption rate.

- Always wear clean, lint-free gloves and use clean tools when working in this area.

**DANGER****Cleaning agents**

Cleaning agents can be detrimental to health and environment.

- Adhere to the relevant regulations and take the necessary precautions when handling and disposing of cleaning agents. Consider possible reactions with the product materials.

Precondition

Gauge deinstalled.



If the cause of the fault is suspected to be in the measuring chamber, the following checks can be made with an ohmmeter.

Tools / material required

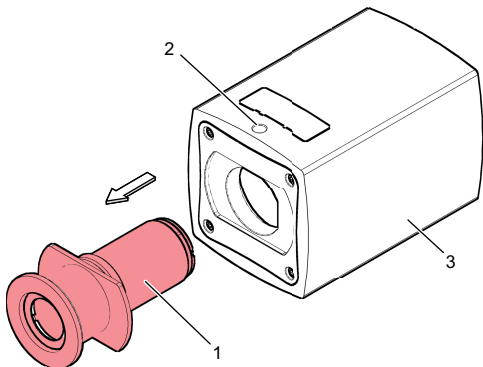
- Allen wrench AF 2.5
- Ohmmeter



- 1** Unfasten the hexagon socket set screw (2) (AF 2.5) and remove the measuring chamber (1) from the electronics unit (3).
- 2** Visually check the optical feedthrough chamber for contamination. Even slight contamination can have a negative effect on the measurement result. Replace the measurement chamber if it is severely contaminated.
- 3** Using an ohmmeter, make following measurements on the contact pins.

Measurement between pins			Possible cause
3 + 6	39.5 ... 40.5 Ω (at 20 °C)	Values outside of the range	Pirani filament rupture
4 + 6	1000 ... 1100 Ω (at 20 °C)	Values outside of the range	Pirani temperature sensor rupture
9 + measuring chamber	∞	$\ll \infty$	Contamination, short circuit cold cathode

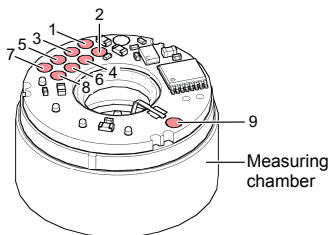

All of these faults can only be remedied by replacing the measuring chamber.

8.1.1 Replacing Measuring Chamber

Precondition

Troubleshooting (measuring chamber) performed.

- 1** Carefully slide the replacement sensor (1) into the electronics unit (3) until the mechanical stop is reached.

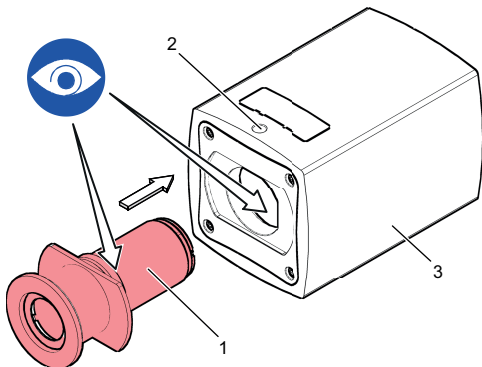

- 2** Fasten the replacement sensor (1) by means of the two hexagon socket set screws (2).

8.2 Troubleshooting



In case of an error, it may be helpful to just turn off the mains supply and turn it on again after 5 s.

Problem	LED	Status	Possible cause	Correction
No voltage at signal output.	ST	off	No supply voltage.	Turn on power supply.
Measurement cannot be started.	HV	blinking green	Gas discharge has not ignited.	Wait, until the gas discharge has ignited (≈ 20 seconds at a pressure of 10-6 mbar).
Measurement data show slight aging process.	LI	lit solid orange	Slight contamination on optical feedthrough.	Service (replacement of the measurement chamber) is pending.
Measurement data show considerable aging process.	LI	lit solid red	Severe contamination on optical feedthrough.	Replace the measurement chamber.
Gauge does not communicate.	LI	single flash red	Internal firmware error	Switch the gauge off and on again after 5 s.
			EEPROM error.	Replace the measure chamber.
Gauge does not communicate.	LI	double flash red	No valid firmware.	Update the firmware.
Gauge does not communicate.	LI	triple flash red	Contact fault to sensor cell.	Insert the measurement chamber into the housing again and fasten it on properly.
			Pirani defective.	Replace the measurement chamber.

9 Returning the Product



WARNING



Forwarding contaminated products

Contaminated products (e.g. radioactive, toxic, caustic or biological hazard) can be detrimental to health and environment.

- Products returned to INFICON should preferably be free of harmful substances. Adhere to the forwarding regulations of all involved countries and forwarding companies and enclose a duly completed declaration of contamination (form under www.inficon.com).

Products that are not clearly declared as "free of harmful substances" are decontaminated at the expense of the customer.

Products not accompanied by a duly completed declaration of contamination are returned to the sender at his own expense.

10 Disposal



DANGER



Contaminated parts

Contaminated parts can be detrimental to health and environment.

- Before beginning to work, find out whether any parts are contaminated. Adhere to the relevant regulations and take the necessary precautions when handling contaminated parts.



WARNING



Substances detrimental to the environment

Products or parts thereof (mechanical and electric components, operating fluids etc.) can be detrimental to the environment.

- Dispose of such substances in accordance with the relevant local regulations.

Separating the components

After disassembling the product, separate its components according to the following criteria:

- Contaminated components

Contaminated components (radioactive, toxic, caustic or biological hazard etc.) must be decontaminated in accordance with the relevant national regulations, separated according to their materials, and disposed of.

- Other components

Such components must be separated according to their materials and recycled.

11 Spare Parts

When ordering spare parts, always indicate:

- all information on the product nameplate
- description and ordering number

	Ordering No.
Replacement sensor DN ISO 16 KF	351-594
Replacement sensor DN 16 CF-R	351- 595
Replacement sensor DN ISO 25 KF	351-597
Replacement sensor DN ISO 40 KF	351-598
Replacement sensor DN ISO 40 CF-F	351-599
Replacement sensor 8 VCR female	351-596

12 Accessories

	Ordering No.
Diagnostic cable for Diagnostic Port (RS232), 2 m	303-333
24 V (dc) power supply with analog out and RS232 line	351-051
Optical window cleaning kit (for gauges with PN 3OF1-xxx-xxxx)	351-052

Further Information

-  [1] Communication Protocol RS232C
 OPG550
 tirb59e1
 INFICON AG, LI-9496 Balzers, Liechtenstein

ETL Certification

RECOGNIZED
COMPONENT



Intertek
3103457

ETL LISTED

The product OPG550

- conforms to the UL Standard UL 61010-1
- is certified to the CAN/CSA Standard C22.2 No. 61010-1-12

EU Declaration of Conformity



We, INFICON, hereby declare that the equipment mentioned below complies with the provisions of the following directives:

- 2014/30/EU, OJ L 96/79, 29.3.2014
(EMC Directive; Directive relating to electromagnetic compatibility)
- 2011/65/EU, OJ L 174/88, 1.7.2011
(RoHS Directive; Directive on the restriction of the use of certain hazardous substances in electrical and electronic equipment)

Product

Optical Plasma Gauge
Augent™ OPG550

Standards

Harmonized and international/national standards and specifications:

- EN 61010-1:2010 + A1:2019 + A1:2019/AC:2019 (Safety requirements for electrical equipment for measurement, control and laboratory use)
- EN 61326-1:2013; Group 1, Class B (EMC requirements for electrical equipment for measurement, control and laboratory use)

Manufacturer / Signatures

INFICON AG, Alte Landstraße 6, LI-9496 Balzers

28 November 2022

28 November 2022



Dr. Christian Riesch
Head of Development



Remo Klaiber
Director of Global Marketing

UKCA Declaration of Conformity

**UK
CA**

We, INFICON, hereby declare that the equipment mentioned below complies with the provisions of the following regulations:

- S.I. 2016/1091, 11.2016
(EMC Regulation; Regulation relating to electromagnetic compatibility)
- S.I. 2012/3032, 12.2012
(RoHS Regulation; Regulation on the restriction of the use of certain hazardous substances in electrical and electronic equipment)

Product

Optical Plasma Gauge
Augent™ OPG550

Standards

Harmonized and international/national standards and specifications:

- EN 61010-1:2010 + A1:2019 + A1:2019/AC:2019 (Safety requirements for electrical equipment for measurement, control and laboratory use)
- EN 61326-1:2013; Group 1, Class B (EMC requirements for electrical equipment for measurement, control and laboratory use)

Manufacturer / Signatures

INFICON AG, Alte Landstraße 6, LI-9496 Balzers

28 November 2022

28 November 2022



Dr. Christian Riesch
Head of Development



Remo Klaiber
Director of Global Marketing

Notes

Notes

Notes



LI-9496 Balzers
Liechtenstein
Tel +423 / 388 3111
Fax +423 / 388 3700
reachus@inficon.com
www.inficon.com

Original: German tinb84d1 (2022-12)



TINB84E1