



Translation of the original operating instructions

UL3000 Fab ULTRA

Helium Leak Detector with ULTRATEST™ Sensor Technology

Catalog No.
550-260

From software version
1.64 (Operating unit)

iinb73en1-11-(2403)



INFICON GmbH

Bonner Strasse 498

50968 Cologne, Germany

Table of Contents

1 About this manual	8
1.1 Target groups	8
1.2 Warnings	8
1.3 Definition of terms	8
2 Safety	11
2.1 Intended use	11
2.2 Duties of the Operator	13
2.3 Owner Requirements	13
2.4 Dangers	13
3 Scope of Delivery, Transport, Storage	15
4 Description	18
4.1 Function	18
4.2 Operation modes	18
4.2.1 Operation mode "Vacuum"	18
4.2.2 Operation mode "Sniffing"	18
4.2.3 Operation mode "Auto Leak Test"	20
4.3 Device setup	20
4.3.1 Overall device	20
4.3.2 Control unit	23
4.3.2.1 START button	24
4.3.2.2 STOP button	25
4.3.2.3 ZERO button	25
4.3.2.4 Meaning of the button LEDs	26
4.3.2.5 Meaning of the status LED	27
4.3.2.6 Assembly of the touchscreen	27
4.3.3 Vacuum connections	29
4.3.3.1 Inlet	29
4.3.3.2 Exhaust	30
4.3.3.3 Purge gas connection	30
4.3.3.4 Venting connection	30
4.3.4 Connections for accessories and control signals	31
4.3.5 Markings on the device	32
4.4 Technical specifications	32
4.5 Factory settings	34

5	Installation	38
5.1	Setup	38
5.2	Connect the supplied accessories	42
5.3	Fastening bracket for sniffer line SL3000 (accessory, optional)	48
5.4	Connecting to the power supply system	49
5.5	Checking the operation of the device	49
6	Operation	52
6.1	Switching on	52
6.2	Basic settings	53
6.2.1	Set language on the user interface	53
6.2.2	Setting date, time and time zone	53
6.2.3	User profile settings	53
6.2.3.1	Overview of Rights Groups	53
6.2.3.2	Select, modify, create user profile	54
6.2.3.3	Modify Personal Settings	55
6.2.4	Switch off Automatic Login	56
6.2.5	Switch on Automatic Login	56
6.2.6	Presentation of the measurement screen	56
6.2.6.1	Changing the presentation of the line graph	57
6.2.6.2	Changing the presentation of the bar graph	58
6.2.6.3	Changing the presentation of the circle graph	59
6.2.6.4	Change general display settings	59
6.2.7	Result display of the Auto Leak Test	60
6.2.8	Change units	60
6.2.9	Change audio settings	61
6.2.10	Change the protection settings	62
6.2.11	Set maintenance interval "Filter sniffer tip" or "Air filter"	63
6.2.12	Activate or deactivate maintenance requests	64
6.2.13	Activating or deactivating calibration requests	64
6.2.14	Extending or reducing operation options	65
6.2.15	Use Favorites	65
6.2.16	Turn notifications on or off	66
6.3	Settings for the measurements	67
6.3.1	Select operation mode	67
6.3.2	Select gas	67
6.3.3	Setting setpoints	67

6.3.4	Activate vacuum ranges.....	68
6.3.5	Influence the speed of the backing pump	68
6.3.6	Set Auto Leak Test	68
6.3.6.1	Consider the background of the test chamber.....	69
6.3.7	HYDRO•S	69
6.3.7.1	Set HYDRO•S.....	69
6.3.7.2	Use HYDRO•S.....	70
6.3.8	Setting the machine factor	70
6.3.9	Set external calibration leak.....	71
6.3.10	Change pressure limits	71
6.3.11	Set and use the function ZERO	72
6.3.12	Vent, purge, regenerate	73
6.3.13	Change leak rate filter.....	75
6.3.14	Change background suppression	75
6.3.14.1	Determine the background of the inlet area.....	76
6.3.15	Change SL3000 settings for sound / light.....	77
6.3.16	Change the sniffer line pressure monitoring	77
6.3.17	Calibrating.....	77
6.3.17.1	Internal calibration	78
6.3.17.2	External calibration	78
6.3.17.3	Calibrate with air helium (sniffer operation)	78
6.3.17.4	Check calibration	79
6.3.17.5	Measure internal calibration leak.....	79
6.4	Measuring	81
6.5	Measuring helium ambient concentration	82
6.6	Measurement data	82
6.6.1	Switch on data recording and configure export.....	82
6.6.2	Display measurement cycles	83
6.6.3	Export measurement data via network	84
6.6.4	Measurement data database: Information	85
6.7	Information	86
6.7.1	Call the latest information to the current measurement value.....	86
6.7.2	Call the latest information to the current calibration value	86
6.7.3	Information on connected accessories	86
6.7.4	Retrieve information about the device	87
6.7.5	Call information on the assemblies	87

6.7.6	Call the energy data information	87
6.7.7	Call information on the HYDRO•S	88
6.7.8	Call information on the SL3000 Sniffer line.....	88
6.8	Log	88
6.8.1	Call the error and warning log	88
6.8.2	Call calibration log.....	88
6.8.3	Call maintenance log	88
6.8.4	Call result log	88
6.9	Device settings.....	88
6.9.1	Viewing and customizing individual parameters	88
6.9.2	Saving and managing sets of parameters	89
6.9.3	Exporting or importing sets of parameters	90
6.10	Updating the software	90
6.10.1	Update the user interface software	90
6.10.2	Updating the software of the basic unit.....	91
6.10.3	Update the software in expert mode	92
6.10.4	Activate additional function	92
6.11	Use external monitor	92
6.11.1	Switch back to the internal monitor	93
6.12	View vacuum diagram.....	94
6.13	Resetting to factory settings.....	94
6.14	Logging off from the device.....	95
6.15	Switching off the device	95
7	Warning and error messages.....	96
7.1	List of warning and error messages	97
8	Cleaning and maintenance.....	115
8.1	Cleaning the housing	115
8.2	Change the filter mat inside the tool box.....	115
8.3	Replacement of the filter mat on the bottom of the device.....	116
8.4	Replacing the SL200 sniffer line filter.....	118
8.5	Replacing the SL3000 sniffer line filter.....	119
8.6	Mounting or changing the gas cylinder	121
8.7	Creating screenshots	122
8.8	Have the device serviced or repaired.....	122
8.9	Maintenance plan.....	124

9 Decommissioning the measuring instrument	126
9.1 Disposing of the device	126
9.2 Returning the device for maintenance, repair or disposal.....	126
10 Accessories and interfaces.....	128
10.1 Accessories and spare parts.....	128
10.2 I/O module.....	132
10.2.1 Create a connection between the device and the I/O module	132
10.2.2 Configuring analog outputs	132
10.2.3 Configure digital inputs	134
10.2.4 Configuring digital outputs	135
10.2.5 Setting up the I/O module protocol	137
10.3 Bus module	137
10.3.1 Creating a connection between the device and the bus module	137
10.3.2 Setting a bus module address	138
10.4 Establish connection between device and SMART-Spray	138
10.5 Network	139
10.5.1 Operate leak detector via web browser (LAN).....	139
10.5.1.1 Configure the LAN connection of the leak detector	139
10.5.1.2 Setting the LAN connection in the PC or Tablet	140
10.5.1.3 Allow client access.....	140
10.5.2 Operate leak detector via web browser (wireless LAN).....	141
10.5.2.1 Configure the wireless LAN connection of the leak detector	141
10.5.2.2 Setting the wireless LAN connection in the PC or Tablet	142
10.5.2.3 Allow client access.....	143
11 Appendix.....	144
11.1 Menu path	144
11.1.1 Diagnostics	144
11.1.2 Settings	144
11.1.3 Information	146
11.2 CE Declaration of Conformity.....	147
11.3 Certificate (TÜV Rheinland)	148
11.4 RoHS.....	149
Index	150

1 About this manual

This document applies to the software version stated on the title page.

Product names may occur in the document, which are added for identification purposes only and belong to the respective owner of the rights.

1.1 Target groups

This instruction manual is intended for the operator of the device and at technically qualified specialists, with experience in the field of leak testing technology.

1.2 Warnings



DANGER

Imminent hazard resulting in death or serious injuries



WARNING

Hazardous situation resulting in potential death or serious injuries



CAUTION

Hazardous situation resulting in minor injuries



NOTICE

Hazardous situation resulting in damage to property or the environment

1.3 Definition of terms



Mention of helium in the manual

The device is a helium leak detector. If you want to use a forming gas instead of helium to detect the hydrogen contained therein, the information for helium also applies to hydrogen.

Automatic tuning / mass setting

This function adjusts the mass spectrometer so that a maximum leak rate indicator is achieved. In order to detect a maximum ion current with the ion detector, the control computer adjusts the voltage for accelerating the ions within the selected mass range accordingly.

During each calibration, there is an automatic adjusted.

Operation mode

The leak detector distinguishes between the "Vacuum" and "Sniffing" operation modes. For the "Vacuum" operation mode, generally the tracer gas flows into the test object. The pressure in the test object is less than the ambient pressure.

In the "Sniffing" operation mode, the tracer gas flows out from the test object and is extracted with a sniffer probe. The pressure in the test object is greater than the ambient pressure.

FINE

FINE denotes the connection to the turbo molecular pump for inlet pressures up to 0.4 mbar. This is also used for the "Sniffing" operation mode.

Forming gas

Forming gas is a collective term for gas mixtures of nitrogen and hydrogen.

GROSS

GROSS denotes the connection to the turbo molecular pump with the lowest sensitivity. This allows high inlet pressures (up to 15 mbar).

Internal helium background

The measurement system of the leak detector also contains a residual amount of helium. This creates an internal measurement signal component (background signal), which overlaps the display of the leak right from the beginning and thus disturbs the search for leaks.

So that this background signal can be suppressed, an internal "background suppression" can be activated with the factory settings. When pressing the START button, the currently internal measuring signal is counted as helium background and subtracted from the measurement signal. If the leak detector has not been in the "Standby" or "Vented" mode for 20 seconds, the last used internal helium background is deducted.

Minimum detectable leak rate

The minimum detectable leak rate which can be detected by the leak detector under ideal conditions ($< 5 \times 10^{-12}$ mbar l/s).

MASSIVE

After selecting the vacuum range "MASSIVE" gross leaks can now be measured from atmospheric pressure.

ULTRA

ULTRA denotes the connection to the turbo molecular pump for the measurement range with the highest sensitivity at inlet pressures below 0.4 mbar (adjustable).

ULTRATEST™ sensor-technology

Highly sensitive mass spectrometer for atomic masses 2, 3 and 4.

Background signal

Helium or hydrogen (as part of water) are natural components of air.

Operation mode "Vacuum": Before any leak detection, a certain amount of the adjusted tracer gas is already in the volume on the surfaces of the test chamber, supply lines, and even in the leak detector itself. This certain amount of tracer gas generates a measurement signal which is called the "Background signal". The ongoing evacuation of the test chamber continuously reduces this background signal.

Operation mode "Sniffing": Ambient air is continuously fed into the leak detector via the sniffer line. The amount of helium or hydrogen occurring naturally in air creates a constant background signal.

Foreline pressure

Pressure of the backing pressure between the turbo molecular pump and the backing pump.

ZERO

There is helium that is weakly bound to the surfaces of a specimen as a natural part of the ambient air and is pumped bit by bit into the measurement system of the leak detector. It produces a slowly decreasing measurement signal.

If you want to hide this background signal or the display of existing leaks, then use the ZERO function.

2 Safety

2.1 Intended use

The device is a leak detector for detecting and measuring leaks in test objects. The device is suitable for leak detection using the vacuum method and the sniffer method.

- Only operate the device as intended, as described in the operating instructions, in order to avoid hazards due to incorrect use.
- Comply with application limits, see "Technical Data".

Incorrect usage

Avoid the following unintended uses:

- Use outside the technical specifications, see "Technical Specifications"
- Exceeding permissible environmental conditions for calibration leaks
- Use in radioactive areas
- Use of the device in dry environments (relative humidity <30%) without consulting INFICON.
- Modification of the device with additional attachments that change the stability. INFICON accessories are excluded.
- Use of accessories or spare parts, which are not included in this instruction manual
- Operating the device in polluted ambient air where conductive particles such as carbon fibers can lead to internal short circuits.
- Testing of wet or damp test objects
- Pumping off aggressive, flammable, explosive, corrosive, microbiological, reactive or toxic substances, creating a hazard
- Operation of the device without consideration of ergonomic aspects such as overtiredness
- Pumping down of condensible fluids and vapors
- Pumping down of gases contaminated with particles
- Placing liquids on the leak detector or in the corrugated hose holder
- Shock loads or vibrations
- Use in locations where the device and display can be damaged by falling objects
- Pumping hydrogen concentrations, which can explode in combination with oxygen. The allowable composition of venal gas mixtures can be read in the safety data sheets of the respective manufacturers.
- Using the device in potentially explosive atmospheres
- Inspecting electrically live conductors or objects with a sniffer line
- Sudden venting of vacuum systems
- Use of the device as a transport vehicle for objects or persons

- Use of the optionally available bottle holder as a means of transport for objects or persons
- Use of the optionally available bottle holder as a foothold
- Connecting non-vacuum-resistant workpieces or test objects without splinter protection
- Pumping out gases containing halogens such as fluorine or chlorine in high concentration or over a long period of time. Use with refrigerants or SF₆.
- Operation without exhaust pipe in poorly ventilated rooms, depending on the type of gases used
- Note: This device is not intended to be used in living areas.

2.2 Duties of the Operator

- Read, observe, and follow the information in this manual and in the work instructions provided by the owner. This concerns in particular the safety and warning instructions.
- Always observe the complete operating instructions for all work.
- If you have any questions about operation or maintenance that are not answered in this operating instructions, contact INFICON service.

2.3 Owner Requirements

The following notes are for companies or any person who is responsible for the safety and effective use of the product by the user, employees or third parties.

Safety-conscious operation

- Operate the device only if it is in perfect technical condition and has no damage.
- Only operate the device properly in accordance with this instruction manual, in a safety and risk conscious manner.
- Adhere to the following regulations and observe their compliance:
 - Intended use
 - Universally valid safety and accident prevention regulations
 - International, national and local standards and guidelines
 - Additional device-related provisions and regulations
- Only use original parts or parts approved by the manufacturer.
- Keep this instruction manual available on site.

Personnel qualifications

- Only instructed personnel should be permitted to work with and on the device. The instructed personnel must have received training on the device.
- Make sure that authorized personnel have read and understood the instruction manual and all other applicable documents.

2.4 Dangers

The measuring instrument was built according to the state-of-the-art and the recognized safety regulations. Nevertheless, improper use may result in risk to life and limb on the part of the user or third parties, or damage to the unit or other property may occur.

Danger for wearers of implants such as pacemakers A loudspeaker is located below the work surface near the handle. The magnetic field of the loudspeaker can interfere with the function of the implant.

- As a wearer of such devices, keep at least 10 cm distance between the speaker magnet and the implant.
 - Also observe the safety instructions of the implant manufacturer.
- Dangers from electric power** There is a danger to life from the contact of conductive parts inside the device.
- Disconnect the device from the power supply prior to any installation and maintenance work. Make sure that the electric power supply cannot be reconnected without authorization.
- The device contains electric components that can be damaged from high electric voltage.
- Before connecting to the power supply, make sure that the mains voltage on site is within the permitted operating voltage range.
The permitted operating voltage range is indicated on the device.
- Explosion hazard** Hydrogen is a flammable and explosive gas.
- Use only tracer gases with a concentration of hydrogen that cannot explode in combination with oxygen. The allowable composition of venal gas mixtures can be read in the safety data sheets of the respective manufacturers.
- Danger from suction effect at the inlet flange** When operating the device in operation mode Vacuum there will be a negative pressure created at the inlet flange. The suction effect on hands or other body parts can cause injuries or trigger uncontrolled movements from a person being frightened.
- Pay special attention to this danger when using a remote control!
 - Make sure that no objects get into the inlet.
 - Protect long hair when the inlet is open, for example by using a hair net.
 - Connect the inlet flange with a test rig or seal it off using a blank flange.
- Injury from bursting objects** There is risk of injury from bursting objects caused by a test object notwithstanding the vacuum pressure when a test object is connected.
- Take appropriate precautions.

3 Scope of Delivery, Transport, Storage

Scope of delivery	Item	Quantity
	UL3000 Fab ULTRA	1
	Exhaust hose adapter ISO-KF flange DN25	1
	Hooks ¹⁾	4
	Power cable strain relief ²⁾	1
	Screws M6 x 12	5
	Guard washer S6	5
	Mains connection cable (country-specific)	1
	Centering ring ³⁾ with filter (for use with applications with dust / dirt accumulation)	1
	Wrench T25	1
	Wrench T30	1
	Digital operating instructions, to download as PDF from www.inficon.com	1
	Unpacking instructions	1
	Inspection certificate calibration leak	1
	Inspection certificate leak detector	1
	Bracket ⁴⁾ for corrugated tube	1
	Self-tapping screws	2
	Sticker with leak rate of the built-in helium test leak	1

Also 2 keys to open the tool flap under the handle.

- ▶ Check the delivery contents after receiving the product to ensure it is complete.

Explanations

1)	For winding the power cord or the sniffer line on the device or on the optional bottle holder. See "Overall device [▶ 20]" and "Connect the supplied accessories [▶ 42]".
2)	To guide the power cord from the device to the ground (avoiding the risk of tripping). See "Connect the supplied accessories [▶ 42]".
3)	For inserting at the inlet flange, see "Inlet [▶ 29]".
4)	For fixing a corrugated tube between the inlet flange of the device and the test chamber or test object respectively". See "Connect the supplied accessories [▶ 42]".

Transport

Observe the following instructions when transporting the device:

 WARNING**Risk of injury due to improper transport of a gas cylinder on the mobile leak detector**

- ▶ When mounting the bottle holder on the leak detector, follow the sequence of action steps as described in the separate mounting instructions.
- ▶ Mount the base of the cylinder holder flush with the gas cylinder.
- ▶ In order not to impair the stability of the leak detector, transport only small to medium-sized cylinders (maximum 10 l, maximum cylinder size including protective cap 98 cm, 200 bar)
- ▶ Check the supplied tensioning straps for visible damage.
- ▶ Always secure the bottle on the bottle holder with both tension straps.
- ▶ Close the valve of the gas cylinder before transport.
- ▶ Dismantle a connected pressure regulator before transport.
- ▶ Protect the valve of the gas cylinder with a valve protection cap during transport.
- ▶ Make sure that any connected spray hose is never under tension.
- ▶ Observe the manufacturer's safety instructions for handling gas cylinders.

 WARNING**Risk of injury due to electric shock**

- ▶ Only move the device when the mains cable is not plugged in.
- ▶ Check the power cord for damage before each use.

 WARNING**Risk of injury from falling or tipping device**

If the device is improperly transported, it can fall or tip over and cause serious injuries.

- ▶ The mobile leak detector is designed for transport on a flat surface. It is not suitable for being carried or lifted by a crane. Use the handle to push the device.
- ▶ For a short, one-sided lifting at smaller obstacles, hold the handle of the device in pairs. This can be necessary, for example, to be able to cross a cable without damaging it.
- ▶ If you use an industrial truck such as a forklift to transport the leak detector, always secure it properly against falling.

⚠ CAUTION**Risk of injury due to limited parking brakes**

Without properly functioning parking brakes, unintentional movements of the device and injuries may occur.

- ▶ To ensure proper functioning of the parking brakes, remove the adhesive strips from the wheels.

⚠ CAUTION**Danger of bruising extremities**

Feet can be rolled over and crushed.

- ▶ Keep feet away from the rollers.
- ▶ Do not pull the device.
- ▶ Hold the device by the provided handle only and slide it.
- ▶ Fix the device at the destination by fixing the front rollers.

NOTICE**Damage to property during transport without transport packaging**

If safe transport by pushing is not possible, the device should be protected from damage by the original packaging.

- ▶ Keep the original packaging for transport.

NOTICE**Damage to the leak detector from industrial trucks**

On the bottom side of the device there are mounting clips for the fans. Industrial trucks such as forklifts can damage these clips.

- ▶ If you cannot push the device to the destination by the handle, we recommend using the original transport box.
- ▶ When using an industrial truck without a transport box, make sure that the clips on the underside of the device (attachment of the floor fans) are not damaged. Forks of forklift trucks must be pushed under the device without contact before lifting.

Storage

Always store the device in compliance with the technical data, see Technical specifications [▶ 32].

4 Description

4.1 Function

The device is a leak detector for detecting and measuring leaks in test objects. The device is suitable for leak detection using the vacuum method and the sniffer method. It uses the ULTRATEST™ sensor technology.

- When using the vacuum method the test object is evacuated and subjected to helium or forming gas from the outside. To do this it is necessary to establish a vacuum connection between the device and the test object.
- When using the sniffer method an overpressure is established in the test object using helium or a forming gas. The test object is then inspected on the outside using a sniffer line.

Before performing leak tests, the leak detector should first be calibrated. Also see "Internal calibration [▶ 78]" and "External calibration [▶ 78]".

4.2 Operation modes

4.2.1 Operation mode "Vacuum"

The inlet flange is located on the upper side of the device.

To be able to perform leak detection using the vacuum method the inlet flange must be connected to the desired test object.

If the pressure in the specimen is less than the surrounding pressure, then helium (which is sprayed over the specimen) can penetrate into the specimen if there is a leak. Helium can be detected in the leak detector using a mass spectrometer.

HYDRO•S

With the operation mode "Vacuum" there is the possibility to use, HYDRO•S. HYDRO•S reduces the time to measuring mode when using large test objects.

The desorption of water vapor in a test chamber produces an unwanted background signal. HYDRO•S separates and suppresses this signal from the helium signal, so that the test can start earlier. A new calibration is required after a change to this mode. In the mode HYDRO•S the lower detection limit is 1×10^{-10} mbar l/s.

See also

 External calibration [▶ 78]

4.2.2 Operation mode "Sniffing"

To scan test objects under overpressure with a sniffer probe, you can connect the SL200 sniffer line or the SL3000 sniffer line.

SL200 The vacuum connection of the sniffer line SL200 is connected to the upper side of the device on the inlet flange.

The electrical connection of the sniffer line SL200 is connected to the connector "ACCESSORIES" on the rear of the device, see "Connections for accessories and control signals [▶ 31]". An additional cable extension is required for the electrical connection, see "Accessories and spare parts [▶ 128]".

SL3000 The sniffer line SL3000 is connected to the connection provided on the rear of the device, see "Connections for accessories and control signals [▶ 31]". Via this connector both the electrical connection and the connection of the vacuum system is made.

As no connection is made to the inlet flange on the upper side of the device, then no vacuum components that are already connected to the inlet flange need to be removed when changing to the operation mode "Sniff".

Comparison

	SL200	SL3000
Detection limit	< 5 x 10 ⁻⁸ mbar l/s	< 2 x 10 ⁻⁷ mbar l/s
Gas flow, distance sensitivity	25 sccm	160 sccm
Available lengths	3.8 m	3 / 5 / 10 / 15 m
Cable sleeve	Stainless steel	Plastic
Good-Bad-Display	YES	YES
ZERO via button	YES	YES
Connection on the device	on the inlet flange and via an electrical connection	via a separate sleeve on the rear of the device
Vacuum and sniffer line can be connected at the same time	-	YES
Display with measurement view	-	YES
Acknowledge faults via buttons on the sniffer probe	-	YES
End standby via a button on the sniffer probe	-	YES
Acknowledge calibration via a button on the sniffer probe	-	YES

4.2.3 Operation mode “Auto Leak Test”

In this mode, you can perform tests on hermetically sealed components with automated processing. If the optional test chamber TC1000 is used, the test starts automatically when the cover is closed.

Results are achieved within a very short time. The internal calibration leak of the leak detector is used to dynamically calibrate the desired test cycle.

Leak rates in the range of 10^{-9} mbar can be detected within 5 seconds.

4.3 Device setup

4.3.1 Overall device



Fig. 1: Front view



Fig. 2: Front view with open flap.



Fig. 3: Back view. The picture shows standard accessories and optional accessories.

4.3.2 Control unit



Fig. 4: Control unit - front view

The control unit consists of a touchscreen and a control panel with the buttons START, Stop and ZERO (background suppression) on the housing.

See also "Assembly of the touchscreen [▶ 27]", see also "START button [▶ 24]".

The LED lighting of the buttons on the control panel changes its display color according to the device state, see also "Meaning of the button LEDs [▶ 26].

The control unit can be rotated.

If you have an operating unit with HDMI interface, you can connect a touch monitor.

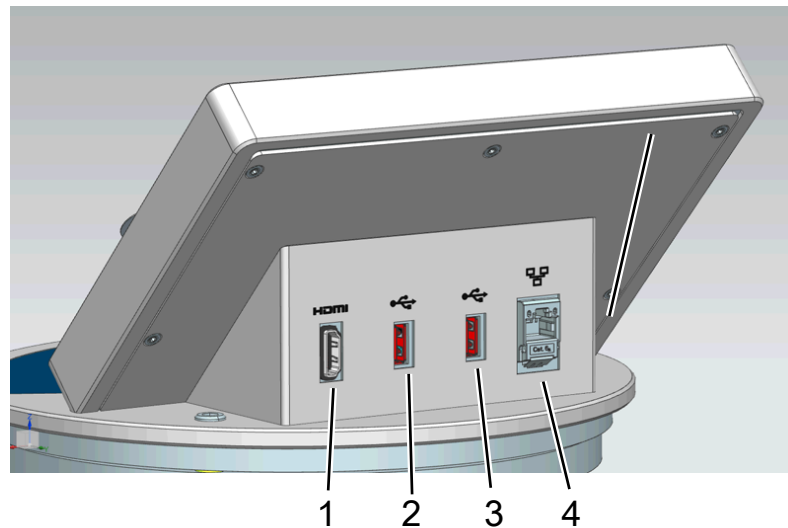

Fig. 5: Control unit - rear view

1	<p>HDMI interface</p> <ul style="list-style-type: none"> For connection to the HDMI interface of a touch monitor, maximum cable length 3 m. See also "Use external monitor [▶ 92]".
2 / 3	<p>USB 2.0 Interfaces</p> <ul style="list-style-type: none"> For connecting the USB cable of a touch monitor, maximum cable length 3 m. For inserting a USB flash drive with update information "Updating the software [▶ 90]". For inserting a USB flash drive for copying measurement data, see "Measurement data [▶ 82]". For inserting a WiFi USB adapter for a WiFi connection, see "Operate leak detector via web browser (wireless LAN) [▶ 141]".
4	<p>Ethernet network interface</p> <ul style="list-style-type: none"> For connection to a LAN network, maximum cable length 30 m (shielded)

The remote control RC1000 is optionally available, see also "Accessories and spare parts [▶ 128].

You can also operate the device using a notebooks or tablets, see also "Operate leak detector via web browser (wireless LAN) [▶ 141]".

4.3.2.1 START button



- To start the measurements.
- Can be operated via the touchscreen of the control panel.
- If you press the START key again during measurement, the maximum leakage rate (Q_{\max}) that has occurred since you pressed START again will be displayed. See also "Assembly of the touchscreen [▶ 27]".

- If you press the START button on the control panel during measurement, the maximum leak rate display is updated.

Function	Touchscreen	Control panel
Starting		START button
Display maximum leak rate	Cannot be operated via touchscreen	Press the START button again.



4.3.2.2 STOP button

- To stop the measurements.
- Can be operated via the touchscreen of the control panel.
- Using the Stop button on the control panel you can do more than just stopping the measurements but also perform ventilation.

Function	Touchscreen	Control panel
Stop		Stop button
Vent		Press the Stop button again and keep it pressed for approx. 2 seconds. (Prerequisite is the setting "ventilation mode" "manual", see "Activate vacuum ranges [▶ 68]".)

4.3.2.3 ZERO button

- To hide the "Background signal", see also "Definition of terms [▶ 8]".
- Can be operated via the touchscreen of the control panel.
- Using the ZERO button you can switch ZERO on and off. For further details see "Set and use the function ZERO [▶ 72]".

Function	Touchscreen	Control panel
Background suppression ON		ZERO button
Background suppression OFF		Press the ZERO button again and keep it pressed for approx. 2 seconds.

The actual measured leak rate is considered to be a background signal. Depending on the selected variant of operation mode the background signal is hidden until the display limit of the respective vacuum range is reached.

Display limits according to factory setting:

1×10^{-1} mbar l/s in MASSIVE

1×10^{-7} mbar l/s in GROSS

1×10^{-10} mbar l/s in FINE

1×10^{-12} mbar l/s in ULTRA

To switch off the function ZERO again, press the button ZERO for about 2 seconds.

The function ZERO should be activated only if the leak rate signal is stable and no leak is measured. See also "Set and use the function ZERO [► 72]".

See also

 Activate vacuum ranges [► 68]

4.3.2.4 Meaning of the button LEDs

START button LED	STOP button LED	Meaning
Off	Flashing red	No connection to the control unit
Pulsing blue	Pulsing blue	Run up
Off	Green	Standby vented (Vent valve open)
Off	Blue green	Standby pumped out (Vent valve close)
Pulsing green	Off	Pump down
Off	Flashing green	Internal calibration
Flashing green	Off	External calibration
Green	Off	Measuring
Yellow (warning, faulty measurement possible)	Off	Measuring with warning not acknowledged
Off	Red	Error

ZERO button LED	
Off	No measurement operation
Off	ZERO blocked
Blue	ZERO off and HYDRO•S off
Green	ZERO ON
Yellow	ZERO off and HYDRO•S on

4.3.2.5 Meaning of the status LED

The status LED is located on the back of the instrument inside of the connector block for the equipment and control signals, see also "Connections for accessories and control signals [▶ 31]".

Status LED	Meaning
Flashing red	No communication with operating unit
Flashing blue	Run up
Blue	Standby
Flashing green	Evacuate (pumping)
Flashing green	Calibrating
Flashing green	Software is started (immediately after the device is switched on)
Flashing green	Boot loader is waiting for a software update (after starting the software update of the basic unit)
Green	Measuring
Yellow	Measuring with warning not acknowledged
Red	Error

4.3.2.6 Assembly of the touchscreen

The display is a touchscreen.



The touchscreen responds to being touched lightly. To correctly select the chosen function, avoid strong pressure.

You can always see symbols for the navigation on the display.

Additionally, you can see, depending on the context, other symbols and elements.

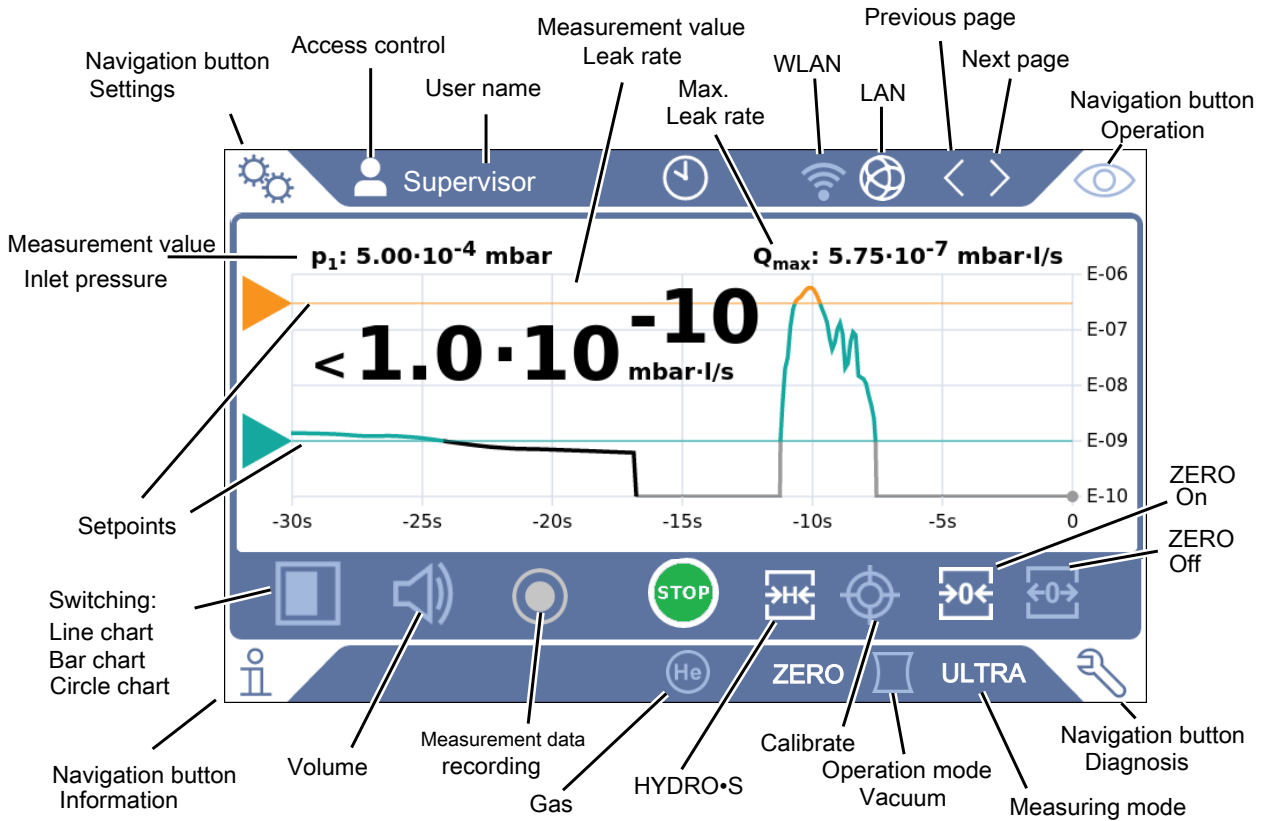

Navigation buttons

The buttons can appear in five different colors:

- Gray: Function is disabled
- Dark blue: Function can be activated
- Light blue: Function is active
- Red: Error is active (navigation button diagnosis)
- Orange: Warning is active (navigation button diagnosis)

	Settings
	Operation
	Information
	Diagnosis

Table 1: Navigation buttons

Function buttons

The buttons can appear in three different colors:

- Gray: Function is disabled
- Light blue: Function can be activated
- White: Function is active

General function symbols	
	Cancel ongoing function











	Call up help for the current function
	Confirm entry or selection
	Load
	Save
	Edit
	Copy
	Delete
	WLAN
	LAN
	Next page
	Previous page

Table 2: Function buttons

Other symbols

	Authorization "User"
	Authorization "Operator"
	Authorization "Supervisor"
	View the time or set the time

See also "Overview of Rights Groups [▶ 53]".

4.3.3 Vacuum connections

4.3.3.1 Inlet

The inlet is located on the upper part of the device. This is a DN 25 KF flange.

If you select the vacuum leak test mode, connect the test object or the vacuum chamber to the flange.

If you are testing applications with dust or dirt, use the O-ring with filter, see "Scope of Delivery, Transport, Storage [▶ 15]". In this case, the pump down times are extended.



Use this inlet also for the connection of the SL200 sniffer line or the test chamber TC1000.

4.3.3.2 Exhaust

WARNING

Danger of poisoning due to harmful gases

Depending on the connected container and the gas contained therein, harmful gases can get into the ambient air via the exhaust filter of the leak detector.

- ▶ Make sure you have protection measure to prevent inhaling hazardous gases.
- ▶ Do not pump out toxic, corrosive, or explosive gases that create a hazard.
- ▶ Connect an exhaust hose. The exhaust gas connection must be continuously connected to an exhaust gas system and must not be closed.

The exhaust is located on the lower side of the device. The exhaust is a tubular connection with internal and external thread. To connect the exhaust hose adapter see also "Connect the supplied accessories [▶ 42]".

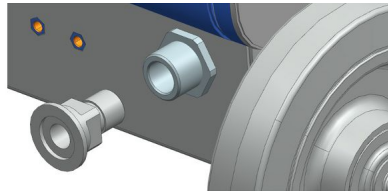

4.3.3.3 Purge gas connection

The connection for the purge gas is located on the lower side of the device, see "Connections for accessories and control signals [▶ 31]". This is a quick connection for hoses with an outside diameter of 8 mm.

To purge use a Helium free gas at atmospheric pressure. The surrounding air may be contaminated with traces of Helium due to spraying or filling up large containers. In such cases connect a gas supply line (this means Nitrogen or fresh air or similar) over the purge gas connection. The pressure in this gas line must not exceed the atmospheric pressure by more than 100 mbar.

4.3.3.4 Venting connection

Normally, the specimens are vented with ambient air after completion of the test. If necessary, the test specimens can be ventilated with another gas (e.g. fresh air, dry air, nitrogen, etc.) via the ventilation connection. The pressure at the ventilation connection must not exceed the atmospheric pressure by more than 100 mbar.

In these cases, a ventilation hose must be connected to the ventilation connection of the device, see "Connections for accessories and control signals [▶ 31]".

4.3.4 Connections for accessories and control signals

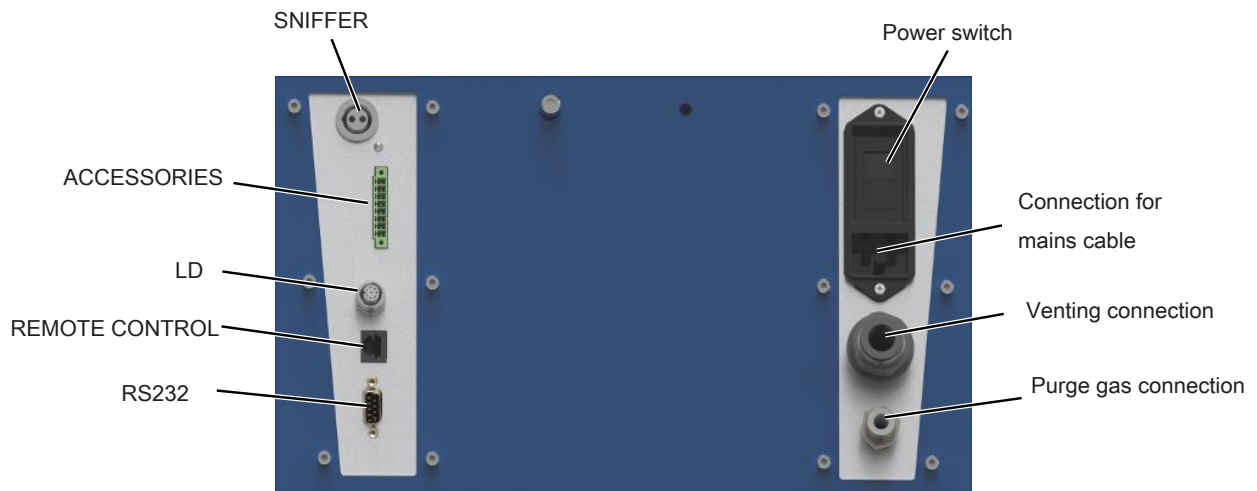

Fig. 6: Connections for accessories and control signals

SNIFFER	For connecting the sniffer line SL3000
ACCESSORIES	Electrical connection of the Sniffer Line SL200 or the Test Chamber TC1000
LD	Connection for bus module BM1000 or I/O module IO1000, maximum*) cable length of INFICON data cable 30 m
REMOTE CONTROL	For connecting the remote control RC1000 via cable, maximum*) length 28 m, or for direct connection of the radio transmitter via an adapter. The remote control is not part of the scope of delivery of the device.
RS232	Connection for accessories and service
Connection for mains cable	For power supply of the device
Venting connection	For hoses with an outside diameter of 14 mm, see also "Venting connection [▶ 30]"
Purge gas connection	For hoses with an outside diameter of 8 mm, see also "Purge gas connection [▶ 30]"

*) To avoid the display of incorrect measured values, the maximum cable lengths specified must be observed.

NOTICE

The electronics of the device can be destroyed.

▶ Only connect devices that are provided for the appropriate interfaces.

The connections for the external devices show a safe disconnection from the power supply and are within the range of the safety extra low voltage (SELV).

4.3.5 Markings on the device



Device cannot be scrapped with the normal domestic waste.



A loudspeaker is located below the work surface near the handle. The magnetic field of the loudspeaker can interfere with the function of the implant.

- As a wearer of such devices, keep at least 10 cm distance between the speaker magnet and the implant.
- Also observe the safety instructions of the implant manufacturer.

4.4 Technical specifications

Mechanical data

	UL3000 Fab ULTRA
Dimensions (L × W × H)	1050 mm × 472 mm × 990 mm
Weight	132 kg
Inlet flange	DN25 KF
Display	
Display	Color display with capacitive touchscreen
Screen diagonal	7 inch
Resolution	800 x 480 pixel
Colors	16.7 M
Background light	LED

Electrical data

	UL3000 Fab ULTRA
Operating voltage	100..240 V ±10%, 50/60 Hz
Max. power consumption	1500 VA
Typical power consumption	
- when pumping	1200 VA
- in measuring mode	700 VA
Max. power consumption 110 V	13A
Max. power consumption 230 V	6A
Short-circuit current rating (SCCR)	300A
Main fuse	Circuit breaker 20 A thermal fuse

	UL3000 Fab ULTRA
Protection class	EN 60529 IP20 UL 50E Type 1
Overvoltage category	II
Electronic interfaces	USB, Ethernet, HDMI, SNIFFER, ACCESSORIES, LD, REMOTE CONTROL, SERVICE

Physical data

	UL3000 Fab ULTRA
Minimum detectable leak rate, vacuum mode	$5 \cdot 10^{-12}$ mbar l/s
Response time, blind-flanged	< 1 s
Maximum inlet pressure (Vacuum range MASSIVE)	Ambient pressure
Helium pumping speed (Vacuum range ULTRA)	4l/s
Air suction capacity of the backing pump	36 m ³ /h
Time to 1 mbar for 50 l volume	~ 49 s
Run-up time	< 3 min
Detectable masses	⁴ He, H ₂ , Mass 3 (e.g. H-D, ³ He or H ₃)
Minimum detectable leak rate, sniffer mode	< 5×10^{-8} mbar l/s
Gas flow through sniffer line SL200	25 sccm
Gas flow through sniffer line SL3000	160 sccm
Measurement range	12 decades
Sound pressure level in Standby	< 70 dB (A) *)
Ion source	2 long-life iridium cathodes, Yttrium oxide coated

*) The A-weighted emission sound pressure level at the operator's premises is less than 70 dB (A) at all times for all foreseeable uses of the device. The noise emission measurement declaration was drawn up in accordance with the harmonized standard DIN EN ISO 3744:2011.

Ambient conditions

	UL3000 Fab ULTRA
Max. altitude above sea level	2000 m
Maximum relative humidity	80 % at 30 °C, linear decrease to 50 % at 40 °C

	UL3000 Fab ULTRA
Storage temperature	0°C ... +50°C
Ambient temperature	+10°C ... +40°C
Degree of contamination **)	2

**) According to DIN EN 61010-1: Only non-conductive contamination. Occasionally, temporary conductivity may occur due to condensation.

4.5 Factory settings

Leak rate setpoint 1	1x10 ⁻⁹ mbar l/s
Leak rate setpoint 2	1x10 ⁻⁸ mbar l/s
Leak rate setpoint 3	1x10 ⁻⁷ mbar l/s
Leak rate setpoint 4	1x10 ⁻⁶ mbar l/s
Automatic purge	On
Volume	2
ZERO mode	I•ZERO 2.0
Calibration request	Off
TMP ventilation	On (can only be changed by service)
Interfaces leak rate unit vacuum operation	mbar l/s
Interfaces leak rate unit sniffer operation	mbar l/s
Interface pressure unit	mbar
Mass	4 (helium)
Protocol on the IO1000 RS232 connection	ASCII
Analog output IO1000 channel 1	Leak rate mantissa
Analog output IO1000 channel 2	Leak rate exponent
Analog output IO1000 scaling	0.5 V / decade
Digital output pin 1 (IO1000)	Calibration request (inverted)
Digital output pin 2 (IO1000)	Error or warning (inverted)
Digital output pin 3 (IO1000)	Setpoint 1 (inverted)
Digital output pin 4 (IO1000)	Setpoint 2 (inverted)
Digital output pin 5 (IO1000)	Measuring
Digital output pin 6 (IO1000)	ZERO active
Digital output pin 7 (IO1000)	Ready for operation
Digital output pin 8 (IO1000)	Calibration active
Digital input pin 1 (IO1000)	VENT
Digital input pin 2 (IO1000)	Sniff
Digital input pin 3 (IO1000)	START
Digital input pin 4 (IO1000)	Stop

Digital input pin 5 (IO1000)	ZERO
Digital input pin 6 (IO1000)	CAL
Digital input pin 7 (IO1000)	Clear
Digital input pin 8 (IO1000)	Purge
Digital input pin 9 (IO1000)	Start/Stop
Digital input pin 10 (IO1000)	No function
Machine factor vacuum mass 2	1
Machine factor vacuum mass 3	1
Machine factor vacuum mass 4	1
Leak rate filter	I•CAL
Cathode	Cathode 1 auto (can only be changed by service)
Lower pressure limit SL200 capillary clogged	0.1 mbar
Upper pressure limit SL200 capillary broken	1 mbar
Audio alarm	TRIGGER
Audio alarm delay	60 s
Notification beep	On
Inlet area offset mass 2	1.3×10^{-10} A
Inlet area offset mass 3	6.7×10^{-14} A
Inlet area offset mass 4	3.3×10^{-15} A
Analog output IO1000 upper exponent	-5
Pressure unit (display)	mbar
Leak rate unit vacuum operation (display)	mbar l/s
Leak rate unit sniffer operation (display)	mbar l/s
Sniffer line light alarm configuration (SL3000 only)	Flashing
Sniffer line light brightness (SL3000 only)	5
Sniffer line beep (SL3000 only)	Beep when setpoint 1
Operation mode	Vacuum
Amplifier test during calibration	On (can only be changed by service)
Alternating preamplifier ranges monitoring	On (can only be changed by service)
Lower pressure limit SL3000 capillary clogged	80 mbar
Upper pressure limit SL3000 capillary broken	200 mbar
Pressure limit MASSIVE -> GROSS	15.0 mbar
Pressure limit GROSS -> FINE	2.0 mbar

Pressure limit FINE -> ULTRA	0.3 mbar
Max. evacuation time gross leak	600 s
Max. evacuation time measurement	1800 s
Gross leak protection leak rate limit	1x10 ⁻³ mbar l/s
Gross leak protection	Off
Particle protection	Off
Background suppression	internal only
Ventilation delay	manually
Device at the LD connection	I/O module
Maintenance messages	all activated
Vacuum ranges	MASSIVE, GROSS, FINE and ULTRA (all ON)
Bus module address	126
Calibration leak external vacuum Hydrogen	1x10 ⁻⁷ mbar l/s
Calibration leak external vacuum mass 3	1x10 ⁻⁷ mbar l/s
Calibration leak external vacuum Helium	1x10 ⁻⁷ mbar l/s
Calibration leak external sniffer Hydrogen	1x10 ⁻⁵ mbar l/s
Calibration leak external sniffer mass 3	1x10 ⁻⁵ mbar l/s
Calibration leak external sniffer Helium	1x10 ⁻⁵ mbar l/s
Local control	Released
Clock style	Analog
Display background at standby	Off
Raise lower leak rate limit	0
Minimum volume	0
HYDRO•S	Deactivated
Note on the exhaust hose connection	Activated
Set maintenance interval	
Sniffer tip filter	1000 h
Air filter	2500 h
Set user	
Name	Supervisor
PIN	1111
Language	English
Auto Leak Test	
Min. test time	5 s
Max. test time	10 s
Part numbering	ON

Part number	1
Warning limit for consecutive failed tests	5
Diagram type	Line chart
Line chart	
Scaling	Logarithmic
Decades	4
Autoscale	On
Lower diagram limit	1×10^{-12}
Time axis	30 s
Bar chart	
Scaling	Logarithmic
Decades	4
Autoscale	On
Lower diagram limit	1×10^{-12}
Circle chart	
Decades	5
Autoscale	On
Lower diagram limit	1×10^{-12}
Data recording	
Export format	CSV en
Enabled	Off
Export metadata	On
WLAN	
Name (SSID)	UL Series
Network key	INFICONUL
Enable	On
LAN	
Method	Off

5 Installation

5.1 Setup



DANGER

Danger due to electric shock

The mains cable connected at both ends may be damaged or the wall socket may be torn out if the leak detector is moved and the mains cable is tensioned as a result.

Moisture penetrating the device can cause personal injury due to electric shock and property damage due to short circuits.

- ▶ Check the power cord for damage before each use.
- ▶ Make sure that the power cord is never under tension.
- ▶ If you want to move the device, disconnect the power cord from the wall socket.
- ▶ To prevent unintentional movement, fix the device at the destination by locking the wheels with the parking brake.
- ▶ Only operate the device in dry environments and only in buildings.
- ▶ Operate the device away from sources of liquid and moisture.
- ▶ Position the device so that you can always reach the plug for unplugging.
- ▶ Do not operate the device in standing water and do not allow even a drop of water or other liquid on the device.



WARNING

Health risk due to exhaust fumes and vapors

Exhaust fumes and vapors from pumps can be a health risk.

- ▶ For operation in poorly ventilated rooms when using gases hazardous to health, connect an exhaust pipe to the exhaust connection.

**⚠ WARNING****Fire hazard due to overload, short circuit and overheating**

- ▶ Observe the permissible ambient conditions.
- ▶ Ensure sufficient ventilation, especially on the ventilation slots on the left and right of the device: There should be free space in the front, to the rear and sides of the unit of at least 10 cm.
- ▶ Do not block the fan inlet in the accessory compartment.
- ▶ Keep heat sources away from the device.
- ▶ Make sure that the power switch or power plug is always easily accessible.
- ▶ Disconnect the device from the mains immediately if smoke is emitted from the device.

⚠ WARNING**Device may fall over due to earthquake**

- ▶ In areas where there is a risk of earthquakes, secure the device to the device handle with a short chain or a tension belt (designed for 1000 N).



Fig. 7: Handle of the device

⚠ CAUTION**Risk of injury due to uncontrolled rolling away**

- ▶ To ensure proper functioning of the parking brakes, remove the adhesive strips from the wheels.
- ▶ To avoid uncontrolled rolling away, fix the device by locking the wheels with parking brake.

⚠ CAUTION**Danger of bruising extremities**

Feet can be rolled over and crushed. Fingers can be pinched and crushed.

- ▶ Keep feet and hands away from the rollers.
- ▶ Do not release wheel brakes with your fingers, only with your foot or a tool.
- ▶ Do not pull the device.
- ▶ Hold the device by the provided handle only and slide it.
- ▶ Fix the unit at the destination by locking the wheels with parking brake.

⚠ CAUTION**Risk of stumbling over the power cord or other lines**

- ▶ To avoid tripping over an obliquely hanging power cable, untwist the cable completely or use the "power line strain relief" to guide the mains cable on the device directly to ground level. See also "Connect the supplied accessories [▶ 42]".
- ▶ Lay other connected lines in such a way that there is no risk of tripping.

NOTICE**Operating system can be hacked via USB or Ethernet**

The Linux operating system used in the leak detector is not updated automatically and can therefore contain security vulnerabilities. This vulnerability may be exploited through the Ethernet and USB interfaces of the leak detector to provide unauthorized access to the system.

- ▶ Ensure that no unauthorized person has access to these interfaces, for example by using a USB port / Ethernet port lock.
- ▶ In order not to jeopardize the security of your company network, never connect the leak detector directly to the public Internet. This applies to connections over WLAN as well as over Ethernet.
- ▶ However, if you want to access the web interface of the leak detector remotely, we recommend an encrypted Virtual Private Network (VPN) connection. However, we cannot assume any guarantee for the security of VPN connections, which are provided by third parties.

**Prevention of measurement errors due to leaks in the helium source in the device surroundings**

We recommend that you regularly check around the device to a distance of 10 m all large helium sources for gross leaks. Use a sniffer line to do this.



Observe the information on transporting the device, see also “Scope of Delivery, Transport, Storage [► 15]”.

Procedure

- So that measurement results are not falsified, use in an area that has a constant ambient temperature if possible.
- For proper functioning of wheels and brakes, remove the adhesive strips from the wheels.
- In order not to block the exhaust opening on the lower part of the device, place the feet of the unit on a firm even surface.
- To easily reach the power switch on the back of the device, ensure there is sufficient free space behind the device.
- Do not expose the device to direct sunlight.

5.2 Connect the supplied accessories

Install the “Hook for power line and sniffer line”

Scope of delivery (amount): Hook (4x), screw M6 x 12 (4x), lock washer S6 (4x)

Required tools (supplied): Wrench T30

- In order to be able to fix the mains cable and, if necessary, a sniffer line on the device, mount the hooks on the device as shown.
- If there is a bottle holder attached to the device, mount the hooks on the bottle holder and secure the screws with the delivered nuts.

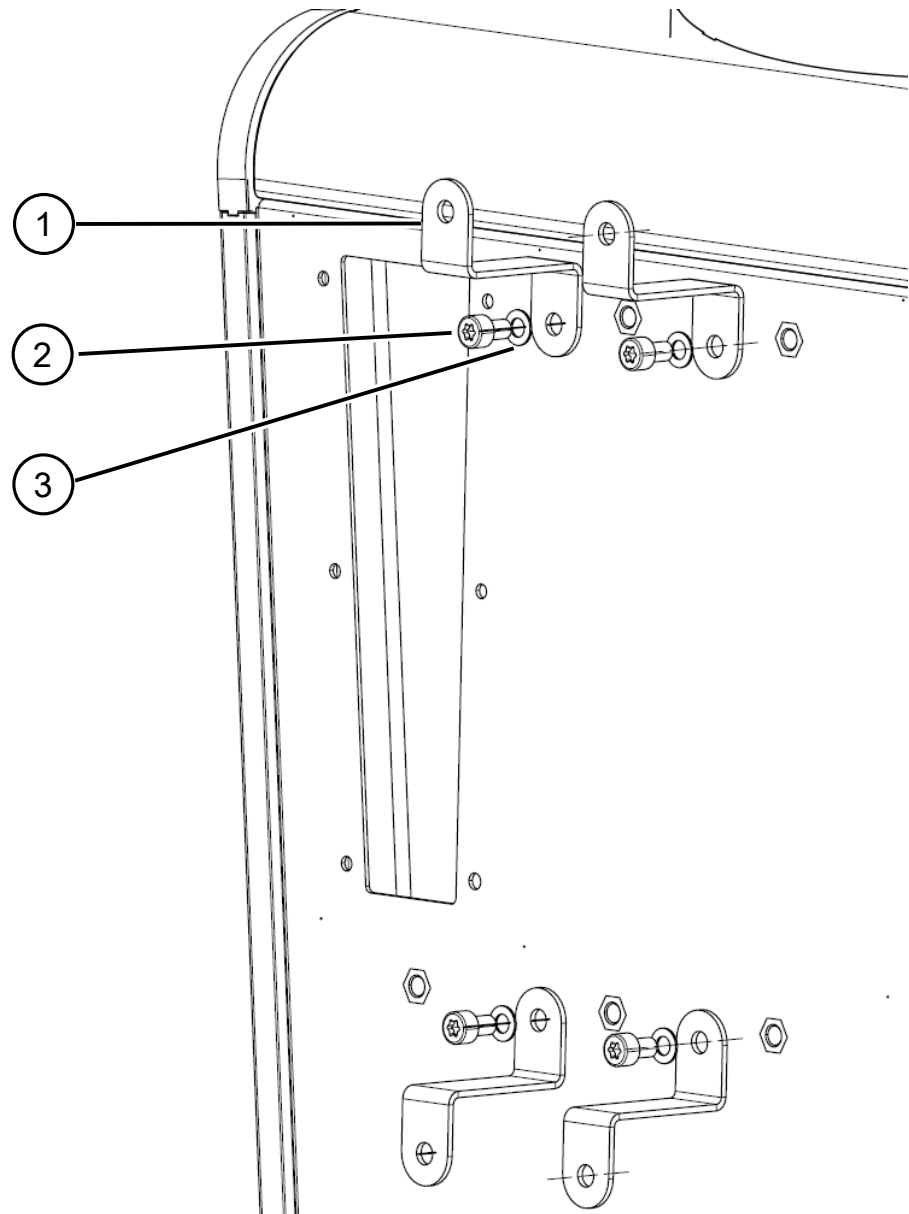

1	Hook	2	Screw M6 x 12
3	Guard washer S6		



Fig. 8: Hook at the instrument or at the optional bottle holder.

Install the “Power line strain relief”

Scope of delivery (amount): Strain relief (1x), screw M6 x 12 (1x), lock washer S6 (1x)

Required tools (supplied): Wrench T30

- To avoid the risk of tripping mount the “strain relief power supply” at the device. Thus the power supply is lead from the device to the ground.
- If there is a bottle holder attached to the device, mount the “power line strain relief” on the bottle holder and secure the screw with a delivered nut.

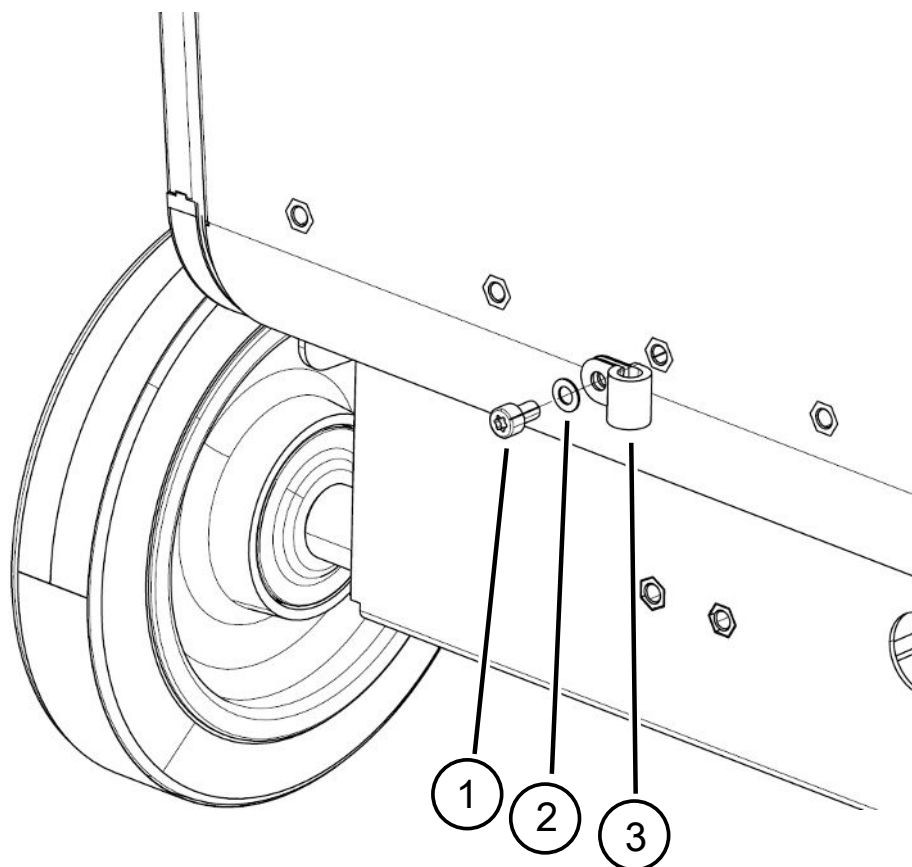

1	Screw M6 x 12	2	Guard washer S6
3	Strain relief		

Install the "Bracket for corrugated tube"

Scope of delivery (amount): Holder complete (1x), screws M6 x 12 (3x), lock washer S6 (3x), self-tapping screws (2x)

Required tools (supplied): Wrench T25 and T30

For fixing a corrugated hose between the inlet flange of the device and the test chamber or test object respectively.

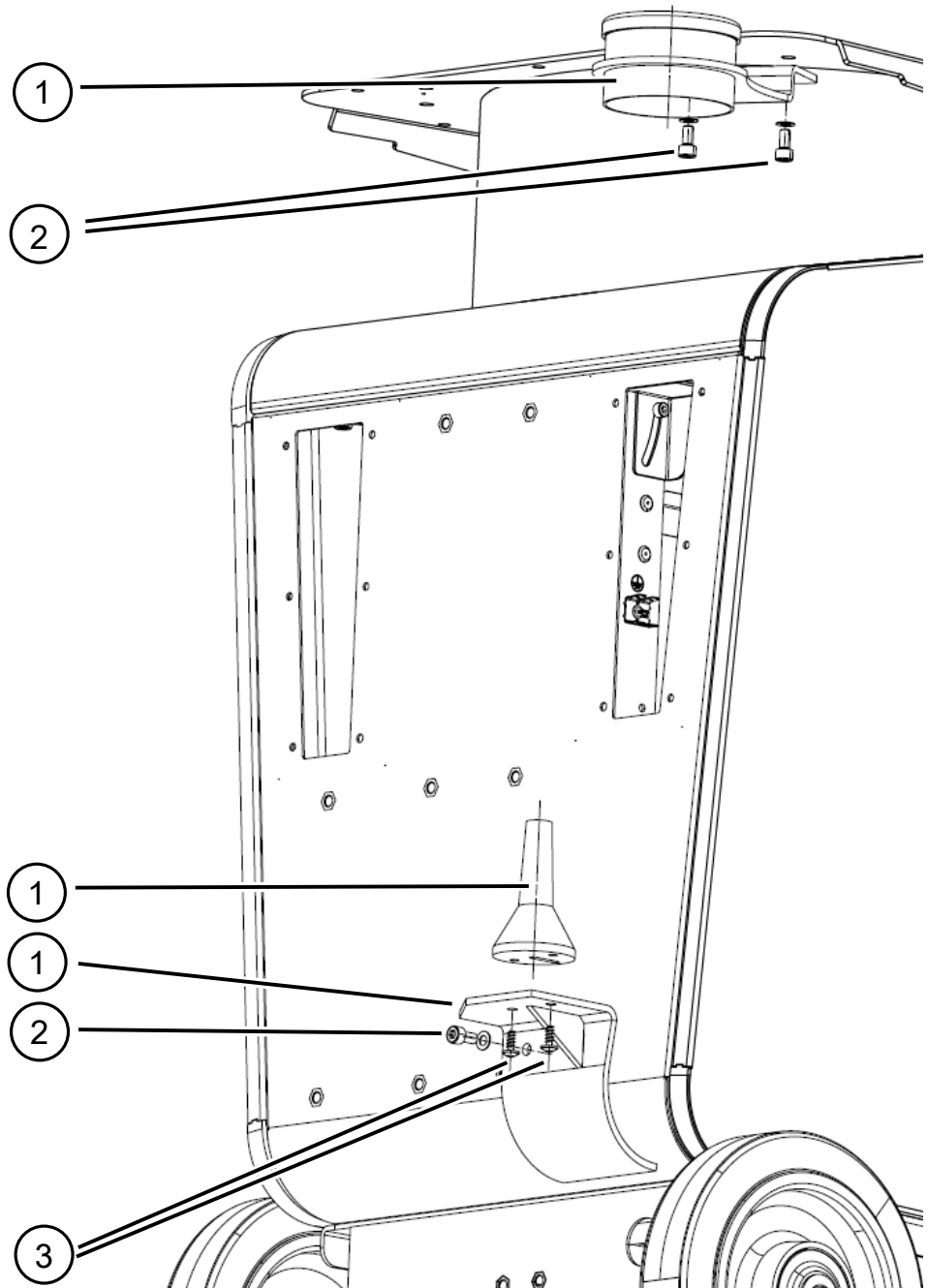

1	Holder complete	3	Self-tapping screws
2	Screw M6 x 12, lock washer S6		

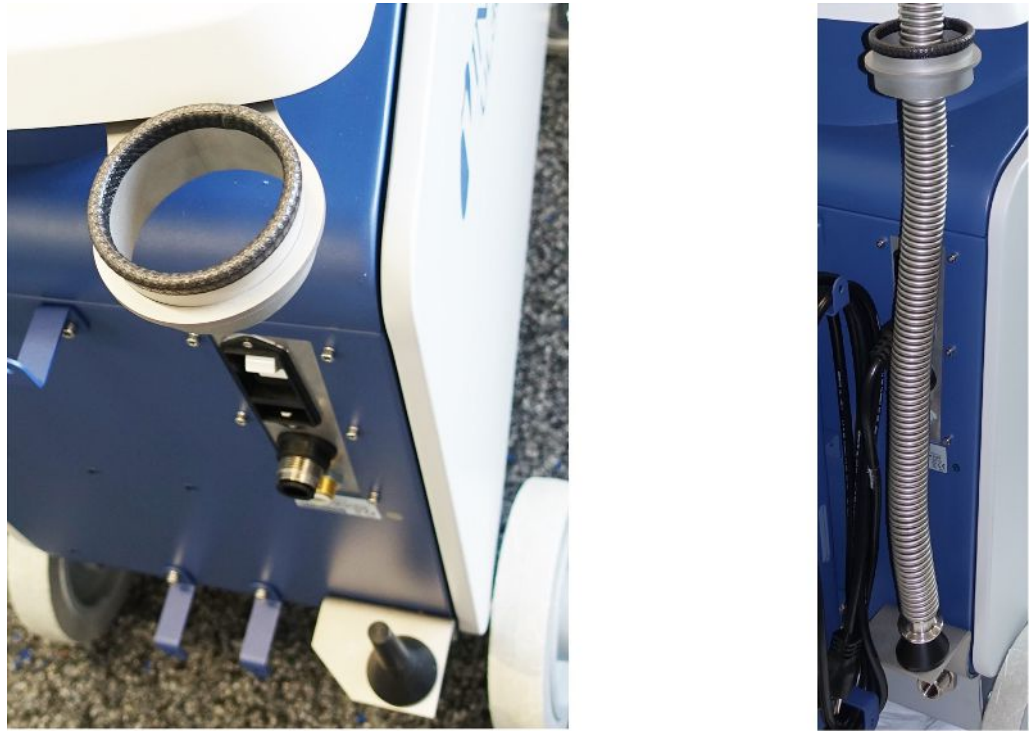

Fig. 9: The bracket for corrugated tube is mounted.



⚠ WARNING

Shortening of the corrugated hose during evacuation

A corrugated hose connected to the inlet is shortened during evacuation.

- ▶ Mount the corrugated hose in such a way that it cannot endanger the stability of the device or flake off when it is shortened.

Mounting the exhaust hose adapter on the device

- To discharge gases through a DN25 exhaust hose, mount the KF flange DN25 exhaust hose adapter supplied in the exhaust port on the rear of the device.
- Use protective gloves when mounting the exhaust hose adapter to prevent cuts.
- To seal the exhaust hose adapter, use Teflon tape. Tighten the adapter clockwise.

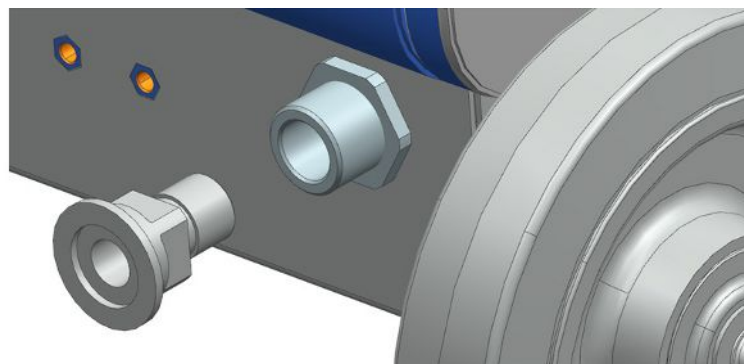

- If you have an exhaust hose with a hose nozzle (G ½ inch male thread), you can alternatively fix this hose nozzle in the exhaust port by turning it clockwise.

 WARNING**Danger of poisoning due to harmful gases**

Depending on the connected container and the gas contained therein, harmful gases can get into the ambient air via the exhaust filter of the leak detector.

- ▶ Make sure you have protection measure to prevent inhaling hazardous gases.
 - ▶ Do not pump out toxic, corrosive, or explosive gases that create a hazard.
 - ▶ Connect an exhaust hose. The exhaust gas connection must be continuously connected to an exhaust gas system and must not be closed.
-

5.3 Fastening bracket for sniffer line SL3000 (accessory, optional)

WARNING

Risk of injury due to sniffer tip

When stumbling, for example over lines, the sniffer tip can cause serious injuries, especially in eye contact.

- ▶ To avoid injury from the sniffer tip, align the sniffer tip in the bracket so that it points away from the operator.

A bracket is available for the sniffer tip. The bracket can be mounted on the back of the device, see also "Overall device [▶ 20]".

Scope of delivery (amount):

Bracket (1x), M6 x 12 mm screws (2x) , S6 x 10 x 0.7 mm washers (2x)

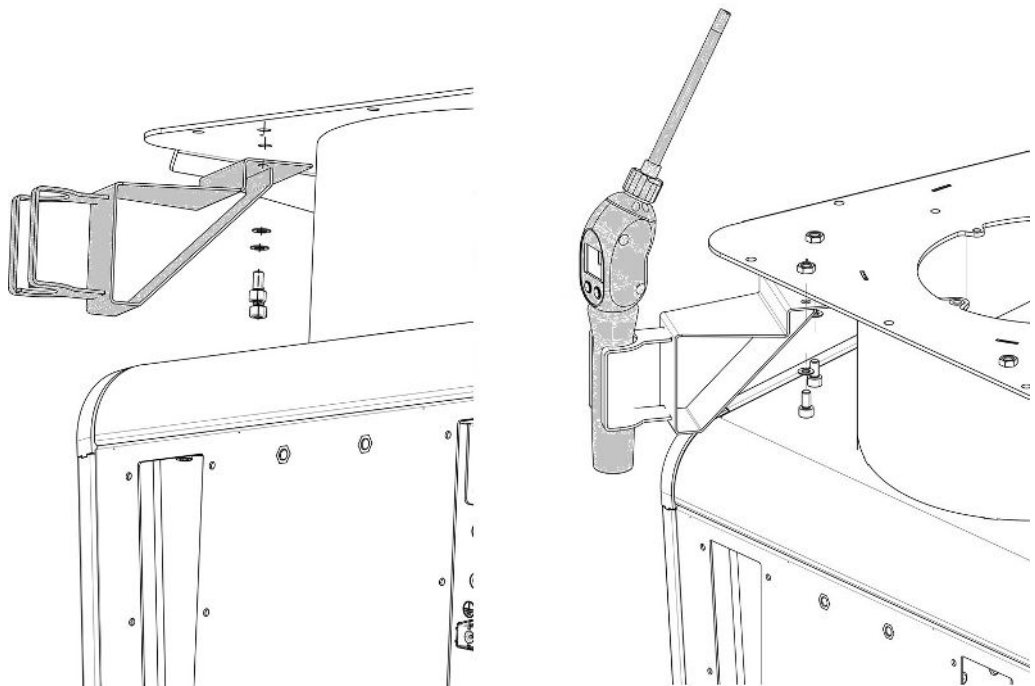

- 1** Mount the bracket as shown using the two screws and washers on the back of the device.
- 2** When not in use, align the sniffer line in the bracket so that it points away from the operator.

5.4 Connecting to the power supply system



⚠ DANGER

Danger due to electric shock

Improperly grounded or fused products may be dangerous to life in case of a fault. The use of the device is not permitted without a connected protective conductor.

- ▶ Only use the included 3-wire power cable.
- ▶ Replace defective power cables.
- ▶ In regions with a power supply of 100 to 120 V with plug type NEMA 5-15 (e.g. North and Central America, Taiwan and Japan), only the supplied "Hospital-Grade" power cord may be used.
- ▶ If the cable is damaged, it must be replaced with an original "Hospital-Grade" spare part (INFICON p/n 200000587).
- ▶ Note that "Hospital-Grade" power cables are marked with the same lettering and green dot as the NEMA 5-15 power plug.
- ▶ Ensure that the appliance coupler (socket on the power switch) is always easily accessible. See also "Connections for accessories and control signals [▶ 31]".
- ▶ Immediately disconnect the device from the mains in case of visible defects. This also applies to the development of smoke.

NOTICE

Material damage due to excessive mains voltage

The device can be damaged if the mains voltage is too high.

- ▶ Before connecting the device, check whether the mains voltage specification on the device matches the locally available mains voltage.

5.5 Checking the operation of the device



NOTICE

Turbo molecular pump can be damaged

The running turbo molecular pump can be damaged by jerky movements or foreign objects.

- ▶ Avoid any jerking movements or vibrations to the device during operation and for up to 2 minutes after switching off.
- ▶ Prevent foreign objects from entering the inlet of the device.

Do not switch on the device when the ambient temperature is less than 10 °C.

- ✓ A DN 25 KF blank flange is available (if not already installed on the inlet flange).
- ✓ A helium calibration leak is available (optional).
 - 1** Unpack the device, take a look at the supply and inspect for any visual damage.
 - 2** Check if the inlet is blind-flanged. If this is not so, flange a blank flange with an O-ring gasket on the inlet on the upper side of the device.
 - 3** Connect the device to the power supply.
 - 4** Switch on the leak detector via the power supply switch.
 - ⇒ After switching on pieces of status information are shown on the touchscreen about the speed of the turbo molecular pump, the foreline pressure, the emission and the active cathode. The start process takes about 3 minutes and is completed with a short acoustic signal. Now, the device is in the "Standby" mode (ready to operate).
 - 5** Press the STARTbutton.
 - ⇒ The inlet is evacuated and then the measuring mode for the measured leak rate is shown.
In case a test object was connected, you would start with spraying helium on the outside.
 - 6** In case you would like to suppress any possible existing background signals (helium background in the test object) press the ZERObutton.
In order to reverse the background suppression press the ZERO button on the control panel for 2 - 3 seconds, see "ZERO button [▶ 25]".
 - 7** Press the Stopbutton.
 - ⇒ The device switches to the "Standby" mode.
If you press the Stop button on the control panel for a few seconds the inlet of the device is ventilated.
 - 8** If you want to end the test now you can switch off the device.
 - 9** If you want to check the internal calibration wait, for getting a better quality of measurement results, 15 to 20 minutes until the device has warmed up.
 - 10** To enter the calibration menu, press the  button.
 - 11** Select "Internal".
 - 12** Press the  button.
 - ⇒ The automatic internal calibration starts and requires approx. 30 seconds.
 - 13** If you want to check the measurement accuracy of the device using the optional helium calibration leak remove the blank flange from the inlet and connect an open helium calibration leak onto the inlet.
 - 14** Press the STARTbutton.
 - ⇒ The inlet is evacuated and the leak rate of the test object is measured and displayed.
 - 15** Press the Stopbutton to interrupt the measurement.

- ⇒ The leak detector changes into the "Standby" mode.
- 16** Press the Stop button on the housing until the message STANDBY/VENTED appears on the display.
 - ⇒ The inlet is now in the vented state.
- 17** Separate the helium calibration leak from the inlet and flange the inlet blind again.
- 18** Switch off the device via the power supply switch.

6 Operation

6.1 Switching on

NOTICE

Damage to the backing pump due to cold ambient temperature

If the ambient temperature is below 10 °C, the device will show a warning on the display after switching on. It is possible to start up the device anyway by confirming this message. This may damage the backing pump.

- ▶ Do not operate the device at an ambient temperature below 10 °C.

- ▶ In order to switch on the device, press the power switch.

⇒ When delivered, the device shows the window "Standby" after run-up.



Fig. 10: Window "Standby"

	Starting the measurement		Calibrate
	Purge		Vent

NOTICE

Possible impairment due to longer downtime

- ▶ To ensure the proper functioning of the leak tester including the built-in pumps, you should switch on the device at least once for about 15 minutes after 6 months of standstill.



Delayed readiness for use after a long period of inactivity

If a leak detector with a SHIMADZU BT70 turbomolecular pump has not been in operation for more than one year, the bearing resistance of the turbomolecular pump may increase during start-up and its temperature may rise considerably. For the installed turbo molecular pump, see "Maintenance plan [▶ 124]".

In this case, the leak detector therefore automatically preconditions the turbo molecular pump during start-up. This preconditioning accelerates the turbo molecular pump to its maximum speed and slows it down again. This process is carried out 5 times in succession and takes a total of approx. 20 minutes.

Once the preconditioning has been successfully completed, the leak detector is ready for use again without any restrictions.



At startup, some notifications or notices for the user may appear. Some of these can be switched on or off, see also "Turn notifications on or off [▶ 66]".

6.2 Basic settings





You are able to save the actual settings of the device at any time, so that you can use them at a later time, see also "Saving and managing sets of parameters [▶ 89]".

6.2.1 Set language on the user interface

You can set the language in the user settings, see "Select, modify, create user profile [▶ 54]".

6.2.2 Setting date, time and time zone

✓  **Supervisor** rights

- 1  > Setup > General > Date and time
- 2 Adjust.
- 3 Save .

Alternatively, press  in the upper window bar and make your settings.

6.2.3 User profile settings

6.2.3.1 Overview of Rights Groups

The rights of a user depend upon which group he belongs to.

User

Members of the group  **User** can

- perform measurements,
- view history of the measurement results,
- view device information,
- view error logs.

Operator

Members of the group  **Operator** have all the rights of the group **User**. Moreover, they can



- Create/modify/delete user,
- Export/delete measurement data,
- Modify measurement settings,

Supervisor

Members of the group  **Supervisor** have all the rights of groups **User** and **Operator**. Moreover, they can

- Create/modify/delete operators,
- Create/modify/delete supervisors,
- Perform software updates,
- Modify date/time.

6.2.3.2 Select, modify, create user profile

✓   **Operator** or **Supervisor** rights

1  > User accounts > Manage user accounts

⇒ Existing users and associated groups are displayed in list form.

2 You have the following possibilities:

To create a new user profile, select  at the bottom of the window.

⇒ The window "User profile" opens.

Otherwise, press an already created user name and choose from the tool bar:

, to load a user profile.

⇒ The login window opens.

, to modify a user profile.

⇒ The window "User profile" opens.

, to delete a user profile.

⇒ A confirmation screen appears.

3 After selecting some tools, the "User profile" window opens. If this window opens, enter a user name, change it, or keep it as required.



- 4 If the "PIN" field is not filled in or you want to change the content, enter a 4-digit PIN.
- 5 To assign the required rights to the user, select a group. Via < and > select between the groups User, Operator and Supervisor. See "Overview of Rights Groups [▶ 53]".
- 6 In the field "Language" assign a language to the user via < and >.
- 7 Save .

6.2.3.3 Modify Personal Settings

As a user with limited rights (**User**) you can also modify your language or PIN. By this the associated user profile is correspondingly adapted. Access to the entire user profile is not necessary.

- 1 Press on your name which appears on the top left of the display.
⇒ The window "User accounts" opens.
- 2 Select the "Change own PIN" or "Change own language" button as required.

See also

-  Logging off from the device [▶ 95]

6.2.4 Switch off Automatic Login



Factory setting

Login: Supervisor

PIN: 1111



Language: English

As per factory settings, after switching on the device the user "Supervisor" automatically logs in and the measurement screen is called. This default user also has the permissions of the group "Supervisor". Without changing this setting, any user can operate all functions without restriction.

You can specify that the login window appears after you turn on the device instead of automatically logging on.

In the login window, all users can login, which have been already registered in the device, see "Select, modify, create user profile [▶ 54]".

✓ **Supervisor** rights

- 1  > User accounts > Manage Automatic Login
- 2 In the "Manage Automatic Login" window, deactivate the option "Active".
- 3 Save .



⇒ After restarting the device, the current settings are applied.

6.2.5 Switch on Automatic Login

You can specify if a user of your choice is automatically logged in after the device is switched on without the login window.

✓ **Supervisor** rights

✓ The requested user was already created. See "Select, modify, create user profile [▶ 54]".

- 1  > User accounts > Manage Automatic Login
- 2 In the "Manage Automatic Login" window, activate the option "Active".
- 3 Enter the name of the user in the "Name" field. Note the uppercase/lowercase.
- 4 Enter the current PIN of the user profile in the "PIN" field.
- 5 Save .

6.2.6 Presentation of the measurement screen



To switch between the different diagram presentation press on the lower left of the measurement screen, see "Assembly of the touchscreen [▶ 27]".

You can select between the following presentations:

- Line chart
- Bar chart
- Circle chart

You can further configure the different diagram presentations. See "Changing the presentation of the line graph [▶ 57]", "Changing the presentation of the bar graph [▶ 58]", "Changing the presentation of the circle graph [▶ 59]".

See also

- 📖 Changing the presentation of the line graph [▶ 57]
- 📖 Changing the presentation of the bar graph [▶ 58]
- 📖 Changing the presentation of the circle graph [▶ 59]

6.2.6.1 Changing the presentation of the line graph



Fig. 11: Presentation of the line graph

✓ **Operator or Supervisor rights**

- 1 > Display > Line chart
- 2 In the field "Scaling" select between "Linear" and "Logarithmic".
- 3 Select between the different viewable "Decades".
- 4 To dynamically adjust the upper and lower limit on the leak rate, activate the option "Autoscale".
- 5 In the field "Time axis" select the length of the time axis "30", "60", "90", "120" or "240" seconds.
- 6 If the option "Autoscale" is not active, select "Lower diagram limit" in the field the desired decade.
- 7 Save .

6.2.6.2 Changing the presentation of the bar graph



Fig. 12: Presentation as bar graph

✓ **Operator** or **Supervisor** rights

- 1 > Display > Bar chart
- 2 In the field "Scaling" select between "Linear" and "Logarithmic".
- 3 Select between the different viewable "Decades".
- 4 To dynamically adjust the upper and lower limit on the leak rate, activate the option "Autoscale".
- 5 If the option "Autoscale" is not active, select "Lower diagram limit" in the field the desired decade.
- 6 Save .

6.2.6.3 Changing the presentation of the circle graph



Fig. 13: Presentation of the circle graph

✓ **Operator** or **Supervisor** rights

- 1 > Display > Circle chart
- 2 If you want to fix the number of displayed decades in the pie chart, under "Decades" select the number of displayed decades. Only effective when automatic scaling is disabled.
- 3 If you want to dynamically adjust the display range to the measured leak rate, activate automatic scaling via the option "Autoscale".
- 4 In the "Lower diagram limit" field, select the desired lower limit for the pie chart. This limit is also effective if the "Autoscale" option is activated.
- 5 Save .

6.2.6.4 Change general display settings

✓ **Operator** or **Supervisor** rights

- 1 > Display > General display settings
- 2 If very small leak rates are of no interest to your application and you want to raise the lower leak rate limit, select between 1 - 6 decades in the "Raise lower leak rate limit". Raising the lower leak rate limit can facilitate the assessment of the leak rate display.
- 3 To set whether to display the internal background leak rate in the "Standby" window, enable or disable the "Display background at standby" option.
 - ⇒ The internal background is created from the remaining gas, which has not yet been pumped out. Very clean systems show a background in the range of 1×10^{-11} mbar l/s. Under normal conditions there is a background of 1×10^{-10} mbar l/s or 1×10^{-9} mbar l/s. For the mathematical treatment of the internal background, see "Change background suppression [▶ 75]".

4 Save

6.2.7 Result display of the Auto Leak Test

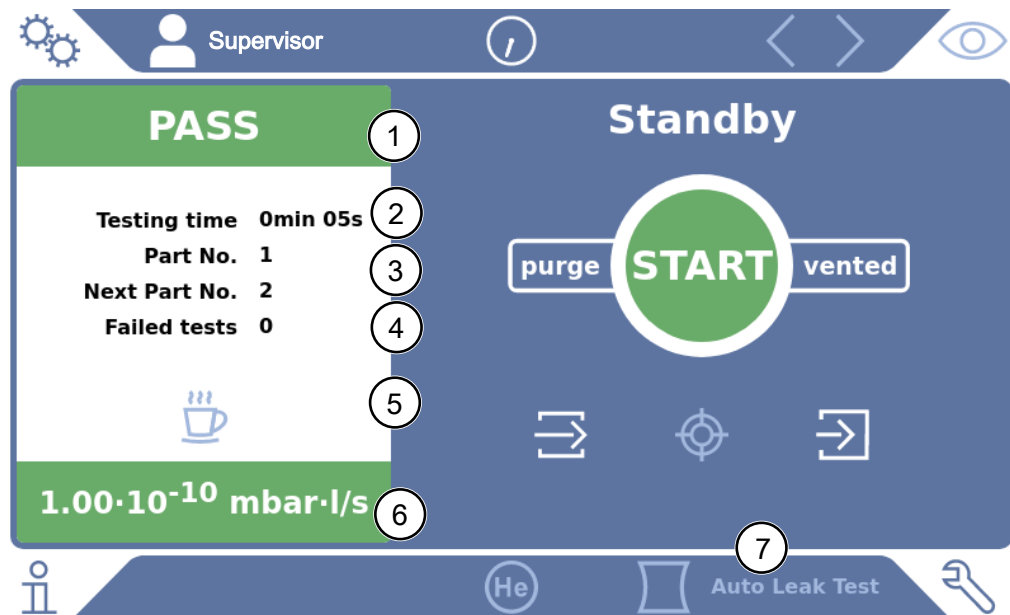

1	"Passed" or "Failed" as the result of the last test under "Part number". Test failed if the leak rate exceeds the setpoint.
2	Actual test time, within set limits, see "Set Auto Leak Test [▶ 68]"
3	Part number, assigned with "Part numbering". Starting from a starting number, the part numbers are automatically incremented, see "Set Auto Leak Test [▶ 68]".
4	Failed tests in sequence are incremented to warning limit. After a passed test, the defect count is reset to 0, see "Set Auto Leak Test [▶ 68]".
5	Auto Leak Test pause: When the test chamber is closed, you can interrupt the measurements by pressing this button and confirming in the following window. The test chamber remains in the pumped-down state.
6	Measurement result
7	Operation mode "Auto Leak Test" active, see "Select operation mode [▶ 67]"

6.2.8 Change units

For the vacuum operation mode you can select between "Torr · l/s", "atm · cc/s", "Pa · m³/s", and "mbar · l/s".

After switching the operation mode "Sniffer" in addition to the modes mentioned above you can also select between the units "oz/yr", "g/a" and "ppm".

You can also choose between the following pressure units: "mbar", "Pa", "atm" and "Torr".

✓ **Operator** or **Supervisor** rights

1 > Setup > General > Settings of units

- 2 If necessary change the units of the "Leak rate unit vacuum", the "Leak rate unit sniff" and the "Pressure unit".
 - ⇒ The option "Equal to display" is activated according to the factory settings so that the units for the interface can be shown exactly as the units of the device.
- 3 In order to independently select the units of the interface deactivate the option "Equal to display".
 - ⇒ Further fields to set the units of the interface are shown.
- 4 To order to set the selected units if required, so that they can also be used for the interface, activate the option "Equal to display".
- 5 Save .

6.2.9 Change audio settings



In addition to the visual display of the measurement results you can change the settings to the volume, to the Notification beep and to the audio alarm.

CAUTION

Damage to hearing due to loud audio

The alarm level of the device can exceed 85 dB(A).

- ▶ Set the volume up to a maximum of "5".
- ▶ Use suitable hearing protection at volume settings above "5".

✓   **Operator** or **Supervisor** rights

1  > Audio

2 In order to change the volume of the audio alarm and the notification sounds, select the desired "Volume". Do not fall below the set value for the "Minimum volume" in the next field.

⇒ Setting range: 0 ... 15

⇒ You can listen to the set volume using the "Test" button.

3 If necessary, change the minimum volume.

⇒ The "Minimum volume" is the volume for the audible alarm which cannot be undershot. If you select a value greater than 0, the lowest volume level is shown on the measurement screen after pressing the volume icon. This allows you to prevent a non-authorized person from setting a value that is below the ambient noise level.

⇒ Setting range: 0 ... 15

4 If you want to define the cause of an alarm or the type of notification beep more accurately, then make your selection with the "Audio alarm mode" between "Proportional leak rate", "PINPOINT", "SETPOINT", "TRIGGER" and "Off".



- ⇒ "Proportional leak rate": The frequency of the audible signal is proportional to the bar graph display or diagram height. The frequency range is 300Hz to 3300Hz.
 - ⇒ "PINPOINT": The sound of the acoustic signal changes its frequency within a specific range of leak rates. This range extends from a decade below the selected setpoint value to a decade above. Below this leak rate range, the sound is constantly low, above the sound is constantly high.
 - ⇒ "SETPOINT": The pitch is proportional to the leak rate. The signal sounds if the leak rate exceeds the set setpoint 1. See also "Setting setpoints [▶ 67]".
 - ⇒ "TRIGGER": If the set setpoint 1 is exceeded, then a two-pitch signal is issued. See also "Setting setpoints [▶ 67]".
- 5 If you want to suppress the alarm for some time after pressing the START button, then set "Audio alarm delay". For example: Time period during the pump down of a test chamber system.
 - ⇒ After pressing the START button the audible signal is activated as soon as the leak rate falls below the setpoint value 1 or the alarm delay time expires. This setting is only for the audible alarm type "SETPOINT" and "TRIGGER".
 - 6 If you wish to have notification beeps, activate the option "Notification beep".
 - 7 Save .

6.2.10 Change the protection settings

You can protect the device from Helium contamination with gross leaks and from the penetration of particles. Furthermore, you can change the maximum evacuation time.

✓ Supervisor rights

- 1  > Setup > Measurement > Protection
- 2 If you want to switch-on the gross leak protection, activate the option "Gross leak protection" and set under "Gross leak protection limit" a shut-down threshold.
 - ⇒ The device closes the inlet valve as soon as the measured leak rate exceeds the shut-down threshold. This will prevent an excess amount of helium from entering the mass spectrometer. Consequently, the leak detector is prevented from becoming contaminated by Helium. The helium entering the specimen can be pumped out using an external pump. If no external pump is being used, we recommend that the test object is vented before continuing with the measurement.
- 3 If you want to prevent particles from being sucked into the device make sure that the test object is first pumped down with another parallel running pump. Activate the option "Particle protection" additionally.
 - ⇒ The leak detector only starts with the pump down once the inlet pressure has fallen below 1 mbar.

- 4** Note: The following setting does not apply if the vacuum range "Massive" is switched on. See also "Activate vacuum ranges [▶ 68]":
To change the maximum evacuation time after a gross leak is detected, enter the desired time in seconds under "Evacuation time gross leak".
- ⇒ This setting determines when a gross leak warning message is signaled. The factory setting is 600 s. If the inlet pressure does not drop below 100 mbar within this time span, a fault message is signaled. This menu point is especially useful with series tests that always have the same test conditions. After pressing the START button the specimen is evacuated. If the corresponding pressure conditions ($p_1 < 100$ mbar) is not reached within the time that is to be set here or falls below, the pump down process is aborted and a warning message appears in the display.
The time that is to be selected depends on the one hand on the desired reaction time for the gross leak message and on the other hand on the volume of the test object and from the effective pumping speed.
If the pump down process should not be aborted enter "0". This corresponds to the entry "infinitely".
- 5** Note: The following setting does not apply if the vacuum range "Massive" is switched on. See also "Activate vacuum ranges [▶ 68]":
To change the maximum evacuation time before the measurement, enter the desired time in seconds under "Evacuation time measurement".
The "Evacuation time measurement" concerns the time until the first approved measurement range is reached.
The factory setting is 1800 s.
- ⇒ If the anticipated pressure conditions are not reached during the evacuation time, a warning message is shown after the expiration of the evacuation time. For the pressure conditions, see also the following setting options:
 > Setup > Measurement > Pressure limits
 and
 > Setup > Measurement > Vacuum > Vacuum ranges
- 6** Save .

6.2.11 Set maintenance interval "Filter sniffer tip" or "Air filter"

To adjust the maintenance interval to the degree of contamination at the location of the device, you can choose between a default value or a self-selected maintenance interval.

✓  **Supervisor rights**

1  > Setup > Maintenance counters

2 Adjust.

⇒ Enter a value of your choice in hours for the "Filter sniffer tip" or press the adjacent "Default value" button (1000 hours).





⇒ Enter a value of your choice in hours for the "Air filter" or press the adjacent "Default value" button (2500 hours).

3 Save .



After performing a maintenance, you should reset the desired period until the next maintenance.

See also

-  Change the filter mat inside the tool box [[▶ 115](#)]
-  Replacement of the filter mat on the bottom of the device [[▶ 116](#)]
-  Replacing the SL200 sniffer line filter [[▶ 118](#)]
-  Replacing the SL3000 sniffer line filter [[▶ 119](#)]

6.2.12 Activate or deactivate maintenance requests

Enables or disables warnings when the time for maintenance is exceeded. The time until the next maintenance is displayed.

✓  **Supervisor** rights

1  > Setup > Maintenance requests

⇒ In the "Enable/disable maintenance requests" window, you can activate or deactivate the maintenance requests for the following modules:

- Calibration leak
- TMP
- Filter sniffer tip
- backing pump
- Exhaust filter
- Air filter

2 Adjust.

3 Save .

6.2.13 Activating or deactivating calibration requests



If the option "calibration request" is not active (factory setting), you only get a calibration request in the following cases:

- The operation mode "Auto Leak Test" has been switched on and the testing time of Auto Leak Test has been changed.
- A SL3000 sniffer line with a new serial number has been connected.
- The operation mode has been changed via the operating unit and there was no calibration in the new operation mode within the last 24 hours.

If the option "calibration request" is active, you will get a calibration request subsequently in the following cases:

- The period of the device is longer than 30 minutes and the temperature deviation compared to the last calibration is larger than 5 Kelvin.
- There was no calibration within the last 24 hours in the currently selected operation mode.



✓  **Operator** or **Supervisor** rights

- 1  > Setup > Measurement > Miscellaneous
- 2 To switch on further calibration requests activate the option "Calibration request". To switch off deactivate this option.
- 3 Save .

6.2.14 Extending or reducing operation options

You can always operate the device via touchscreen. Furthermore, you can change the factory setting, which enables the operation via buttons on the control panel and via the remote control.





✓  **Operator** or **Supervisor** rights

- 1  > Setup > Measurement > Miscellaneous
- 2 Under "Local control" you make your choice in the selection field between:
 - ⇒ Released.
The buttons START, Stop and ZERO on the control panel and also the buttons of the remote control are released. The operation via touchscreen can be disabled, however, if no user is logged on.
 - ⇒ Release after login.
The buttons START, Stop and ZERO on the control panel and also the buttons of the remote control can be operated after a user has logged in to the device with a valid PIN.
 - ⇒ Locked.
The device can only be operated via the touchscreen. The START, Stop and ZERO buttons on the control panel are locked. The buttons of the remote control can also not be used.
- 3 Save .



6.2.15 Use Favorites

To shorten the time spent searching menus for frequently used functions, create freely assignable menu keys in the "Favorites" window.





Use Favorites:

- ▶ Press the icon with your permission , ,  and then the "Favorites" button or choose alternatively
- ▶  > User accounts > Favorites
 - ⇒ The Favorites window with 9 buttons is displayed. Assigned buttons can be used to quickly call up desired functions.

Create Favorites:



- 1 In the Favorites window, press an empty button.
- 2 Select the desired menu name from the displayed list overview and confirm your selection with .
 - ⇒ Alternatively, you can press  in the "Favorites" window, mark an empty entry and select the desired menu name from the list overview using the  shown.

Change or delete favorites:

- 1 In the Favorites window, press .
 - ⇒ This opens the "Manage" window in which you can tap the desired entry.
 - ⇒ The icon  and the icon  for deletion are displayed.
- 2 After pressing the icon , the list overview is displayed with the menu names from which you make your selection and save it by pressing .



6.2.16 Turn notifications on or off

✓ Supervisor rights

- 1  > Setup > General > Notifications
- 2 If necessary, change the setting of the "Note on the exhaust hose connection" field.
 - ⇒ Option activated: Note is displayed (factory setting)
 - ⇒ Option deactivated: No note
- 3 If necessary, change the setting of the field "Note on upcoming maintenance of calibration leak".
 - ⇒ Option activated: Note is displayed (factory setting)
 - ⇒ Option deactivated: No note
- 4 If necessary, change the "Number of weeks between note and prompt for calibration leak maintenance".
 - ⇒ Setting range: 1 to 12 weeks (factory setting: 4 weeks)
- 5 Save .

6.3 Settings for the measurements

6.3.1 Select operation mode

- ✓  **Operator** or **Supervisor** rights
 - 1  > Operation mode
 - 2 Choose between "Vacuum", "Sniff / SL200", "Auto Leak Test" and "Sniff / SL3000".
 - 3 Save .

6.3.2 Select gas





DANGER

Danger from a Hydrogen explosion

Hydrogen can explode in combination with oxygen. The allowable composition of venal gas mixtures can be read in the safety data sheets of the respective manufacturers.

- ▶ Ensure that the share of hydrogen does not exceed the described concentration.

- ✓  **Supervisor** rights
 - 1  > Setup > Measurement > Mass
 - 2 Make a selection from:
 - "Hydrogen" H₂ (2 amu)
 - "Helium" ⁴He (4 amu)
 - "Mass 3" ³He (3 amu)
 - 3 Save .



6.3.3 Setting setpoints

You can set the leak rate for the setpoint to 1, 2, 3 and 4 separately.

When the setpoints are exceeded:

- If the setpoint 1 or 2 is exceeded, the measurement line in the measurement window changes color.
- The setpoint relay of the digital output switches, see also "I/O module [▶ 132]" or the interface description.

Also setpoint 1 defines the trigger point for the different alarms, see also "Change audio settings [▶ 61]". It is also the limit for I•ZERO, see "Set and use the function ZERO [▶ 72]".

- ✓  **Operator** or **Supervisor** rights
 - 1  > Setpoints

- 2 Adjust.
- 3 Save .



6.3.4 Activate vacuum ranges



Vacuum ranges

You can activate the vacuum ranges MASSIVE, GROSS, FINE and ULTRA for your measurements.

All 4 areas can be activated at the same time. If several areas are activated, they switch automatically depending on the inlet pressure. In this way different sensitivities can be measured with.

At least one range must be activated.

✓   **Operator** or **Supervisor** rights

- 1  > Setup > Measurement > Vacuum > Vacuum ranges
- 2 Activate the desired vacuum range under "Vacuum range".
- 3 Save .



6.3.5 Influence the speed of the backing pump

✓  **Supervisor** rights

- 1  > Setup > Measurement > Vacuum > Backing pump
- 2 If necessary, change the setting of the "backing pump mode" field.
 - ⇒ "Automatic" (factory setting)
The speed of the backing pump is lowered if possible.
 - ⇒ "Fixed"
The backing pump is operated at a fixed speed.

6.3.6 Set Auto Leak Test

Please take note of the information on the operation mode "Auto Leak Test" and the notes on measuring. See also Operation mode "Auto Leak Test" [▶ 20], "Select operation mode [▶ 67]", "Measuring [▶ 81]" and "Result display of the Auto Leak Test [▶ 60]".

✓   **Operator** or **Supervisor** rights

- 1  > Setup > Measurement > Vacuum > Auto Leak Test
 - ⇒ You can edit the following settings:
 - "Min. Test time"
 - "Max. test time"
 - "Leak rate setpoint 1": To change the setpoint 1. The same threshold value can alternatively be set in the window "Setpoint values", see "Setting setpoints [▶ 67]".
 - "Part numbering": After activating this function, a number is assigned for each test. This facilitates the traceability of test results, see "Call result log

[▶ 88]”.

- “Part number”: To assign a part number. For each measurement, this partial number is counted as starting number.



- “Warning limit for consecutive failed tests”: After the entered number has been reached, a warning message is displayed.

- 2 Adjust.
- 3 Save .

6.3.6.1 Consider the background of the test chamber

If unexpected results, such as many failed tests are displayed in succession, we recommend performing a "Reference measurement". You can repeat such a measurement at regular intervals.

- ✓ Test chamber is mounted, empty and closed.
- ✓ Operation mode “Auto Leak Test”
- ✓ Device is in the "Standby" state.

- 1 Press .
- 2 Select "Reference measurement".
- 3 Press .

⇒ The chamber is evacuated 3 times and vented.

⇒ After cleansing, the current helium background is measured.

⇒ The new values of the measured background are automatically stored and subtracted from the results of future measurements.

6.3.7 HYDRO•S

If you are testing large test objects during vacuum operation, you can reduce the time to ready for measurement by using HYDRO•S, see also Operation mode "Vacuum" [▶ 18].



6.3.7.1 Set HYDRO•S



In addition to the basic setting described here, the availability of HYDRO•S depends on additional requirements, such as the selected operation mode and the operating state, see “Use HYDRO•S [▶ 70]”.

- ✓  **Supervisor** rights

- 1  > Setup > Measurement > HYDRO•S

- 2 Make a selection from:
 - "Deactivated" (factory setting) if you do not use HYDRO•S and also want to dispense with manual switchability.
 - "Manual" if you want to activate or deactivate HYDRO•S by pressing on  the measurement screen. See also "Assembly of the touchscreen [▶ 27]".
 - "Automatic" if you want to use HYDRO•S as much as possible.
- 3 Save .
- 4 After setting HYDRO•S to "Manual" or "Automatic" perform a calibration, see "Calibrating [▶ 77]".

6.3.7.2 Use HYDRO•S

HYDRO•S manual

- ✓ HYDRO•S is set to "Manual", see "Set HYDRO•S [▶ 69]".
- ✓ Gas type helium (mass 4) is selected, see Select gas [▶ 67].
- ✓ Operation mode "Vacuum" is active.
- ✓ Vacuum range ULTRA is reached.
- ✓ Device is in the "Measuring" state.
- ✓ The current leak rate is larger than 3×10^{-10} mbar l/s.
- ✓ ZERO is switched off. After switching on HYDRO•S the ZERO can be used again. See "Set and use the function ZERO [▶ 72]".
- ▶ Switch HYDRO•S by pressing  on or off on the measurement screen. By means of Stop you always switch off HYDRO•S.

HYDRO•S automatic

- ✓ HYDRO•S is set to "Automatic", see "Set HYDRO•S [▶ 69]".
- ✓ The other requirements for the above-mentioned manual operation are also fulfilled.
- ✓ The leak detector is in the current measurement range for at least 5 s.
- ▶ HYDRO•S switches on automatically.
 - ⇒ HYDRO•S is switched on only once in a measurement cycle (stop / start).
 - ⇒ You can always switch HYDRO•S on and off,  even if the automatic function is activated.
 - ⇒ Manual switching of HYDRO•S deactivates the automatic operation until the next measuring cycle (stop / start).



6.3.8 Setting the machine factor

If you are measuring in the operation mode "Vacuum" and using an external pump in parallel, the measured leak rate would be too small in comparison to the leak rate based on an internal calibration.

If you would like to compensate for this you can multiply the measured leak rate with the suitable machine factor and then have the value shown. This factor is used only in the vacuum mode and not in the sniffing mode.

When taking into consideration the Helium pumping speed of the device, the machine factor can also be estimated. The measurement of the leak rate is more accurate using an external calibration leak with the test object - once with the external pump switched and once without. The difference between the results determines the machine factor.

The machine factor can also be used to correct the leak rate display with respect to the air equivalence. The machine factor for this correction is 0.37.

✓   **Operator** or **Supervisor** rights

✓ The operation mode "Vacuum" is set.

1  > Setup > Measurement > Calibration leak



⇒ The field "Machine factor helium" is shown.

2 Adjust.

3 Save .

6.3.9 Set external calibration leak

To use an external calibration leak for calibration, enter the leak rate of the calibration leak.

✓   **Operator** or **Supervisor** rights

1  > Setup > Measurement > Calibration leak

2 Adopt the printed value and the associated unit from the calibration leak or certificate.

Do not change the combination of the printed value and associated unit, even if your device is otherwise set to other units!

3 Save .

See also

 External calibration [[▶ 78](#)]

6.3.10 Change pressure limits

Pressure limits for the vacuum mode.

Using this function the factory settings for the switching points between the vacuum ranges MASSIVE, GROSS, FINE and ULTRA can be changed. This can be necessary if the device is pumped down with gases other than air, such as Argon. The reason for this is the gas type dependence of the internal Pirani pressure gauges.

By changing the preset switching point this can be compensated for. The pressure signal of the gas type dependent inlet pressure indicator (Pirani) can deliver different switching values after the adjustment of the sequence control of the device.

✓  **Supervisor** rights

1  > Setup > Measurement > Pressure limits

- ⇒ You can change the set pressure limits. This concerns:
 - MASSIVE -> GROSS
 - GROSS -> FINE
 - FINE -> ULTRA
- 2 To restore the factory settings for air after a change by pressing a key, press the "Air default" button.
 - ⇒ All factory settings for air are set.
 - ⇒ If required, you can set the pressure limits individually. See also "Factory settings [▶ 34]".
- 3 To set the values for argon by pressing a button, press the "Argon Standard" key.
 - ⇒ Then the following settings deviating from the factory settings for air are used:
 - MASSIVE -> GROSS: 4 mbar
 - GROSS -> FINE: 1 mbar
 - FINE -> ULTRA: 0.2 mbar
 - ⇒ If required, you can set the pressure limits individually.
- 4 Save .

6.3.11 Set and use the function ZERO

Why should I use ZERO?

To be able to clearly measure small leakages the function ZERO should be used. With each leak detection there is a "Background signal" (see "Definition of terms [▶ 8]") that disrupts the search or the measurement of leakages.

- To hide the background signal, activate the function ZERO.
- You can also use ZERO to hide a currently displayed leakage, which interferes with searches for other or even smaller leaks.



A currently displayed leak is hidden through ZERO.

By using the function ZERO not only is the background signal hidden, but also the representation of a current leak.

- ▶ If you want to prevent this, select the function ZERO only if not measuring a leak at the same time.

Activate or deactivate ZERO

ZERO is activated by factory settings.

✓  **Supervisor** rights

- 1  > Setup > Measurement > ZERO and filter
- 2 If necessary change "ZERO mode". The factory setting is "I•ZERO 2.0".
 - ⇒ You can choose between "I•ZERO 2.0", "ZERO" and "Switched off".
 - ⇒ If you select "OFF", the ZERO button does not work.

3 Save .

⇒ If ZERO is activated, start the function by pressing the ZERO button. See also "ZERO button [ 25]".

How do I switch the ZERO function ON?

Briefly press the ZERO button on the control panel or the touchscreen .

How do I switch the ZERO function OFF?

Press the ZERO button on the control panel for more than 2 seconds or on the touchscreen .

"Vacuum" operation mode, effect of ZERO setting

If you use the "I•ZERO 2.0" setting, after pressing the ZERO button the displayed background signal is faded out depending on the current drift. Typically, the display limit falls in several steps. The size of the current display limit is a dimension with which leakages can currently be measured. When measuring, the current display limit should be at least one decade below the expected measured value.

If you use the "ZERO" setting, the currently displayed leak rate value is set to the lower display limit after pressing the ZERO button.

"Vacuum" operation mode, "HYDRO•S" switched on, setting "I•ZERO 2.0" or "ZERO"

When you press the ZERO button, the current leak rate value is set to the lower display limit.

Note: The ZERO button should not be pressed when there is a rapidly falling background, otherwise, when compared to the background change, small leak rate signals may be incorrectly hidden.



"Sniffing" operation mode, setting "I•ZERO 2.0" or "ZERO"

When you press the ZERO button, the current leak rate value is set to the lower display limit.

6.3.12 Vent, purge, regenerate

Vent



In measuring mode, you use this function to vent the inlet of the device and a test specimen connected to it after a measurement. Without the suction effect of the vacuum, a test specimen can be easily changed.

✓   **Operator or Supervisor** rights

1  > Setup > Measurement > Vacuum > Vent

2 If necessary, change the setting in the "Ventilation delay" field.

⇒ "Immediately": If "Immediately" is activated, the ventilation is triggered when changing to Standby.

- ⇒ "Manually": Factory setting. If "manually" is activated, the ventilation is activated after a longer press on the button Stop or by pressing at  in the window "Standby". See also "Switching on [▶ 52]".
 - ⇒ "No ventilation"
- 3 If necessary, change the setting in the "Soft ventilation" field.
 - ⇒ Option activated: The inlet is ventilated only very slowly. This can be useful to avoid a strong flow in the test object, which could possibly entrain particles.
 - ⇒ Option deactivated: Factory setting
 - 4 Save .

Purge

By activating the flushing function (with dry backing pumps), a small gas flow is let into the backing pump in the "standby" state. The function may be useful to remove condensed water vapor from the pump chamber of the backing pump or to reduce the helium background.



WARNING



Risk of suffocation due to nitrogen or argon as purge gas

The use of nitrogen or argon as purge gas may cause suffocation at high concentrations in indoor air.

- ▶ Take precautions to avoid high concentrations of these gases in enclosed spaces.
- ▶ Connect an exhaust gas line.
- ▶ Make sure that the pressure in the gas line to the purging gas connection does not exceed 100 mbar gauge pressure above atmospheric pressure.

You can automatically purge the backing pump for 20 seconds when you change to "Standby".

✓   **Operator** or **Supervisor** rights



- 1  > Setup > Measurement > Vacuum > Purge
- 2 If necessary activate the option "Automatic purge".
 - ⇒ If you switch off the automatic purging, you can switch purging on or off in the standby window by pressing .
- 3 Save .

Regeneration

It may happen that too much helium has entered the interior of the device and no accurate measurements are possible (helium contamination). The regeneration provides the user with an automatic start-stop-vent cycle to degrade such elevated helium background.

An active regeneration is shown in the display.

Regeneration is automatically deactivated after 60 minutes.

- ✓  **Operator** or **Supervisor** rights
- ✓ You have not activated the setting "No ventilation" under "Ventilation mode", see above.
- ▶  > Regeneration
 - ⇒ You can start the regeneration in the opened window and stop it as desired or wait for the automatic deactivation of the regeneration after 60 minutes.



6.3.13 Change leak rate filter

The leak rate filter "I•CAL" is preset. I•CAL ensures that the averaging time is optimally adapted to the leak rate range.

The abbreviation I•CAL stands for "Intelligent Calculation Algorithm for leak rates". This ensures that the signals are averaged at optimal time intervals and this is based on each leak rate range. I•CAL also determines interference spikes, which bear no relevance to the leak rate signals and delivers unusually short reaction times even with low leak rate signals. The algorithm used offers excellent sensitivity and response time.

With the leak rate filter "Fixed" there is also a filter with a fixed time constant available.

Procedure



- ✓  **Supervisor** rights
 - 1  > Setup > Measurement > ZERO and filter
 - 2 Make a selection between "I•CAL" and "Fixed" under "Leakage rate filter".
 - 3 Save .

6.3.14 Change background suppression

The internal background suppression is preset.

The measurement system of the leak detector contains a residual amount of helium and hydrogen even without connection to a test chamber. This creates an internal measurement signal component already before pressing the START button.

After activating "Background suppression" the internal background and selectably also the background in the inlet area is deducted from the leak rate. This happens after pressing the START button automatically.

- ✓  **Supervisor** rights
 - 1  > Setup > Measurement > ZERO and filter
 - 2 Make your selection in the field "Background suppression" between "Internal only", "Inlet area" and "Switched off".
 - ⇒ Internal only

Factory setting. With every measurement the internal measurement signal component of the device is deducted by pressing the START button. The accuracy of the measurement results are no longer impaired by the internal

background.

At the time of pressing the button START:

In order to determine a new internal background, the leak detector must be in standby mode for at least 20 seconds and the flushing or gas ballast valve must not have been open during this time. If you want to make sure that a current internal ground is used in the following measuring operation, do not press START, until the background display in standby has changed from low opacity (grayed out) to normal opacity. To make the background display visible in standby mode, activate the corresponding function, see "Change general display settings [▶ 59]".

⇒ Inlet area

Additionally to the deduction of the internal background, pressing START with every measurement also deducts the background of the inlet area.

IF you would like to switch this on, make sure that the background of the inlet area is determined, see "Determine the background of the inlet area [▶ 76]".

We recommend that the calculation of the inlet area background is occasionally repeated, because the device pumps down any background present in the inlet area after a certain time.

⇒ Switched off

No background suppression.

3 Save .



High background value

If the actual background is higher than 1×10^{-8} mbar l/s, it can no longer be automatically deducted. The high background must be pumped down in this case.

6.3.14.1 Determine the background of the inlet area

This function determines the value of the internal Helium background.

If "Zero and Filter" are shown in the window under background suppression with value "Inlet area" selected, this value is then deducted from the measured signal when START is pressed. See also "Change background suppression [▶ 75]".

- ✓ Inlet blank flange
- ✓ Operation mode Vacuum Mode
- ✓ The device is in the state "Standby" or "Measure".

1 Press .



2 Select the calibration "Inlet background".

3 To start the automatic determination of the intake background, press .

6.3.15 Change SL3000 settings for sound / light

You can set up how you are to be additionally informed on the display of the touchscreen concerning the measurements. The settings take effect with Setpoint 1.

✓  **Operator** or **Supervisor** rights

- 1  > Setup > Measurement > Sniffing > SL3000 sniffer line
- 2 Select "Sniffer line light alarm configuration".
⇒ As choices there are "Lighter", "Off" or "Flash".
- 3 Select "Sniffer line light brightness".
⇒ You have a choice of OFF / 1 - 6.
- 4 Switch-on the "Sniffer line beep" sniffer audio.
⇒ As choices there are "Off" or "Beep when setpoint 1" available.
- 5 Save .



6.3.16 Change the sniffer line pressure monitoring

In the operation mode Sniffer (SL200 or SL3000) automatic pressure monitoring is activated. The preset pressure limits define a maximum and a minimum inlet pressure. If the pressure does not lie within these limits then generally the caliper is either blocked or broken. Fault messages are issued according to the following rules:

Inlet pressure > Upper limit: Caliper defective.

Inlet pressure < Lower limit: Gas flow is too low through the caliper (blocked caliper).

✓  **Supervisor** rights

- 1  > Setup > Measurement > Sniffing > Capillary surveillance
⇒ You can change the following settings, to view the preset values see "Factory settings [▶ 34]".
"Lower pressure limit SL200 capillary clogged" (lower limit)
"Upper pressure limit SL200 capillary broken" (upper limit)
"Lower pressure limit SL3000 capillary clogged" (lower limit)
"Upper pressure limit SL3000 capillary broken" (upper limit)
- 2 Adjust.
- 3 Save .

6.3.17 Calibrating



In order to be able to measure leak rates correctly, the leak detector has to be adjusted at regular intervals by calibration. The mass spectrometer is adjusted automatically.

You can perform the calibration using the device internal calibration leak or using an external calibration leak. Normally, calibration should take place on a daily basis or if there is some doubt as to the measurement ability of the device.







- ▶ When using hydrogen or helium-3 (^3He) as tracer gas an internal calibration is not possible. In this case, use an external calibration leak.
- ▶ The operation modes "Vacuum" and "Sniffing" must be separately calibrated when using an external calibration.
- ▶ A calibration should only take place when the device is at operating temperature. Calibrate at least 20 minutes after switch-on.
- ▶ For systems with a greater distance to the test object, we recommend the use of an external calibration leak at the location of the test object.
- ▶ When using the internal calibration leak, observe the setting of the machine factor, see also "Setting the machine factor [▶ 70]".

6.3.17.1 Internal calibration

- ✓  User rights
- ✓ The device is in the state "Standby" or "Measure".
 - 1 Press .
 - 2 Select the calibration "Internal".
 - 3 Press .
- ⇒ The device performs an internal calibration.

6.3.17.2 External calibration

- ✓   **Operator** or **Supervisor** rights
 - 1 Mount the calibration leak on the inlet of the device.
 - 2  > Setup > Measurement > Calibration leak
 - 3 Adjust the leak rate of the calibration leak used, see also "Set external calibration leak [▶ 71]".
 - 4 Place the device in the state "Standby" or "Measure".
 - 5 Press .
 - 6 Select the calibration "External".
 - 7 Press .
 - 8 Follow the instructions on the screen.

6.3.17.3 Calibrate with air helium (sniffer operation)

In the lower layers of the Earth's atmosphere, the air contains about 5.2 ppm helium (volume fraction).

This helium concentration can be used to calibrate the leak detector in sniffer mode.





The calibration method described here is inaccurate!

- ▶ For optimum accuracy, always use the internal calibration leak or an external, calibrated calibration leak.



- 1 Connect one sniffer line and configure the leak detector as follows:
 - Sniffer operation mode
 - Mass 4 (helium)
 - leak rate unit ppm
 - External calibration leak: 5.2 ppm
- 2 Select the calibration type "external without zero point measurement" and start the calibration procedure.
- 3 Only sniff normal ambient air if the leak detector prompts you to hold the sniffer to the external calibration leak. Make sure that the room air does not contain any additional helium, e.g. through the use of using helium spray guns.
- 4 Confirm the measured value with .

6.3.17.4 Check calibration

The calibration can also be checked without changing calibration factor. This tells you whether a new calibration is necessary.

- ✓  User rights
- ✓ The device is in "Standby" or "Measure" mode.
 - 1 Press .
 - 2 Select "Proof".
 - ⇒ The check is started and the calibration factor is recalculated.
 - ⇒ The newly calculated calibration factor is displayed.
 - ⇒ If the newly calculated calibration factor deviates considerably from the stored calibration factor, a prompt for new calibration is displayed.

6.3.17.5 Measure internal calibration leak

- ✓  User rights
- ✓ The device is in "Standby" or "Measure" mode.
 - 1 Press .
 - 2 Select "Measure internal calibration leak".
 - 3 Press .
 - ⇒ The calibration leak is opened, the measured leak rate is displayed and compared with the target value.



Matching of the measured value of the internal calibration leak and the default value of the internal calibration leak does not mean that the measuring system is absolutely accurate if the internal calibration leak was used for calibrating the leak detector. See also "Setting the machine factor [▶ 70]".

6.4 Measuring

- ✓ The inlet flange on the upper side of the device is prepared for the pending measurement. Your test specimen or the SL200 sniffer line is normally connected there.
- ✓ Alternatively, the sniffer line SL3000 is connected to the back of the device (optional). In this case, the inlet flange on the top of the device should be closed with a blank flange.
- ✓ Possible alternatives to the operating possibilities on the device are set up (optional):
I/O module, bus module, remote control, wireless LAN connection to the notebook or tablet. Also see "Accessories and spare parts [▶ 128]" and "Operate leak detector via web browser (wireless LAN) [▶ 141]".
 - 1 Switch on the leak detector via the power supply switch.
 - 2 Make sure that the desired operation mode is set (see "Select operation mode [▶ 67]").
 - 3 Make sure that the correct basic settings and the settings for the current measurement are carried out. See "Basic settings [▶ 53]" and "Settings for the measurements [▶ 67]".
 - 4 When performing a calibration, note the 20 minute warm-up time. See "Calibrating [▶ 77]".
 - 5 In standby mode, initiate the measurement process by pressing the START button.
 - ⇒ If you want to ensure that a current internal background is used in the following measuring operation, please observe the notes in chapter "Change background suppression [▶ 75]".
 - 6 Keep track of the measurement results either as line, bar or circle graph, see "Presentation of the measurement screen [▶ 56]" and "Assembly of the touchscreen [▶ 27]".
 - 7 To display the maximum leak rate (Q_{max}) on the measurement screen during a measurement, press the START button again. Also see "START button [▶ 24]" and "Assembly of the touchscreen [▶ 27]".
 - 8 To measure small leak rates more easily, press the ZERO button when required, see "Set and use the function ZERO [▶ 72]".
 - 9 Record the measured values if necessary, see "Switch on data recording and configure export [▶ 82]" and "Assembly of the touchscreen [▶ 27]".
 - 10 Switch the instrument off.



See also

- 📖 Change general display settings [▶ 59]

6.5 Measuring helium ambient concentration

The natural content of helium in the ambient air is about 5.2 ppm.

You can examine the ambient air for an increased helium content (helium contamination) to determine the appropriate time for further measurements.

- ✓ The operation mode "Vacuum" is set.
- ✓ The gas chosen is "helium" ^4He . See also "Select gas [▶ 67]".
- ✓ There are no long hoses connected to the "purge gas connection". There, the air enters the device whose helium concentration is measured. See also "Connections for accessories and control signals [▶ 31]".
- ✓ The device is in the "Standby" state.
 - 1 Press .
 - 2 Select "I•CHECK".
 - 3 Press .
 - 4 View the measurement result.

6.6 Measurement data

You can record measured values in the internal database. Recording can be done automatically during the measurement or via the "Record measurement data" button in the measurement screen.

See also "Switch on data recording and configure export [▶ 82]".

You can also export the displayed measured values.

See also "Display measurement cycles [▶ 83]".

For the export you can either use a USB flash drive or the network connection, see also "Export measurement data via network [▶ 84]".



6.6.1 Switch on data recording and configure export

NOTICE



Reduces the service life of the memory

The recording of many measured values reduces the service life of the internal memory.

- ▶ Disable data recording when you no longer need it.



- ✓   **Operator** or **Supervisor** rights





- 1  > Setup > Data recording

- 2 To record immediately after starting a measurement, activate the option "Enabled".
 Note: Data recording occurs during the measurements, i.e. while the measurement screen is displayed. See also "Display measurement cycles [▶ 83]".
 ⇒ This option is deactivated as standard. To start or stop a recording without activating this option press  in the measurement display.
- 3 Under "Export format" select between "CSV en", "CSV de" and "JSON".
 ⇒ Standard is "CSV en".
 For "CSV en", the column separator is a comma.
 For "CSV de", the column separator is a semicolon.
 "JSON" is a language-independent data format.
 ⇒ Export files have a default name with timestamp and extension (e.g. icmeas20160720-082829.csv).
- 4 To export measurement data in addition to the measurement data, such as the serial number of the device, activate the "Export metadata" option.
 ⇒ Note: If other data is exported in addition to measurement data, this can increase the effort required for data post-processing.
- 5 Save .

6.6.2 Display measurement cycles

The measuring cycle is the time between pressing the START button and the STOP button. You can view the associated information and optionally edit 2 free text fields.

- 1  > Measurement data > Measurement cycles
 ⇒ Stored measurement cycles with ID, start and end time are displayed.
- 2 To view the details of a measurement cycle, select the desired entry by touching it and press .
 ⇒ All information belonging to the measurement cycle and a chart are displayed.

Detail 1	Detail 2	Chart
ID	500	   
Start	19.05.2021 (07:33:24)	
Stop	19.05.2021 (07:33:57)	
Operation mode	Vacuum	
Mass	Helium	
Leak rate unit	mbar-l/s	
Pressure unit	mbar	
Free text 1		
Free text 2		

- 3 To edit text in the "Free text 1" and "Free text 2" fields, press .

- ⇒ Alternatively, you can edit "Free text 1" and "Free text 2" from the "Measurement cycles" window. Select an entry by tapping on it and press .
- 4 To change the displayed period in the detailed view on the chart, swipe to the right or left on the display.
To change the time axis, press ⊕ to zoom in or ⊖ to zoom out. The value axis is always set automatically.

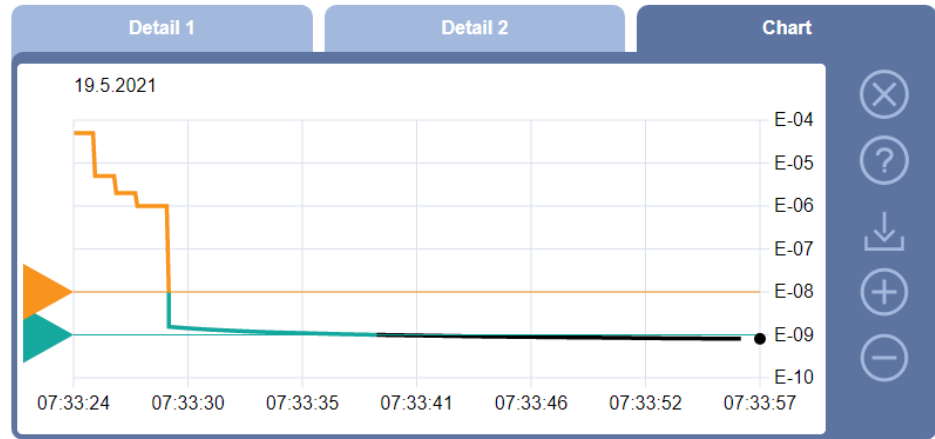



- 5 To export the displayed cycle, connect a USB flash drive (FAT32 formatted) to the leak detector and press .

6.6.3 Export measurement data via network

In addition to access to the graphical user interface, you also have the option of retrieving specific measurement data from your leak detector.

A data interface was implemented for this purpose (REST interface).

This interface responds to requests on port 3000 when valid parameters are transmitted with data in the requested format.

- ✓ A network connection has been established between the leak detector on one side and the PC or Tablet on the other side.
See also "Operate leak detector via web browser (LAN) [▶ 139]" or "Operate leak detector via web browser (wireless LAN) [▶ 141]".
- ✓ The measurement data were recorded. See also "Switch on data recording and configure export [▶ 82]".
- ▶ You have two options for exporting the desired measurement data:
 - ⇒ You use the convenient options to first display measurement cycles and click on . See also "Display measurement cycles [▶ 83]".
After activating the  from the PC or Tablet, a file with the relevant measurement data is offered for download.
 - ⇒ Alternatively, enter your request with the desired parameters as URL in your browser. With this procedure, you not only set the desired time period (a block of maximum 24 hours), but you can also select the file format and data scope (with or without metadata).
When accessing via LAN, use the IP address found under  > Device >

Network.

When accessing via WLAN, use the URL found under  > Setup > Network > WLAN.

Example 1:

`http://192.168.11.124:3000/md?f=csv_en&c=4&d=mr`

Returns measured values and metadata of the measurement cycle with ID 4 in the format "csv_en".

Example 2:

`http://ul.inficon.com:3000/md?dts=2018-11-05T23:00:00.000Z&dte=2018-11-06T23:00:00.000Z&f=json&d=r`

Returns measured values between 2018-11-05T23:00:00.000Z and 2018-11-06T23:00:00.000Z in the "json" format.

Parameter	Name	Description	Options	Example
c	Measurement cycle	Querying one or more measurement cycles via ID	IDs of the measurement cycles Separated by comma for several	c=3 c=3,5,8
dts	START	The start time of the time period from which data is to be exported.	A date in ISO format in UTC time	dts=2018-08-02T17:15:12.000Z
dte	End	The end time of the time period from which data is to be exported.	A date in ISO format in UTC time	dte=2018-08-02T17:45:35.000Z
f	Format	The data format of the export	json, csv_en, csv_de Standard: csv_en	f=json f=csv_en
d	Scope	Scope of the data. With or without metadata	mr: Meta and measured values m: Meta only r: only measured values Standard: mr	d=mr d=r

6.6.4 Measurement data database: Information

The maximum size of the database corresponds approximately to the number of measured values that are generated over the period of one month during continuous recording. This corresponds to a database size of approx. 1.5 GB.

If storage is needed for the recording and the maximum database size (in measurement values) has been exceeded, the oldest records are automatically deleted so that 5% of the specified capacity is freed for new data.

✓  **Supervisor rights**

▶  > Measurement data > Database information

⇒ The following is displayed:

"Current database size" in [Byte]

"Measurement values": Number of measurement values in the database

"Max. database size": Number of measurement values that can be stored in the database

"Level"

"Oldest record": Time stamp of the oldest measurement value

"Newest record": Time stamp of the newest measurement value

See also

 Resetting to factory settings [[▶ 94](#)]

6.7 Information

6.7.1 Call the latest information to the current measurement value

▶  > Measurement values > Leak rate and pressure

⇒ The leak rate and different pressure values are shown.

▶  > Measurement values > Temperature

⇒ Different temperature values are displayed.

▶  > Measurement values > Run times

⇒ The current runtime information is displayed.

6.7.2 Call the latest information to the current calibration value

▶  > Calibration

6.7.3 Information on connected accessories

▶  > Accessories > I/O module

⇒ If an I/O module is connected, you will find details.

▶  > Accessories > Bus module

⇒ If a bus module is connected, you will find details.

6.7.4 Retrieve information about the device

Diverse information on the device is shown: Software and serial numbers, network information and operating hours.

- ▶  > Device > Identification

- ▶  > Device > Network

- ▶  > Device > Operating hours

- ▶  > Device > MSB

6.7.5 Call information on the assemblies

Diverse measurement values and information to the following assemblies is shown: Preamplifier, ion source, turbo molecular pump (TMP), processor assembly MSB, backing pump and its frequency converter.

- ▶  > Assemblies > Preamplifier

- ▶  > Assemblies > Ion source

- ▶  > Assemblies > TMP

- ▶  > Assemblies > Backing pump

6.7.6 Call the energy data information

Various measured supply voltages and electrical powers are displayed.

- ▶  > Energy > Voltage (1)
 - ⇒ In this window the first part of the information to the voltage is shown.

- ▶  > Energy > Voltage (2)
 - ⇒ In this window the second part of the information to the voltage is shown.

- ▶  > Energy > Power

6.7.7 Call information on the HYDRO•S

The internal parameters for HYDRO•S are displayed.

- ▶  > HYDRO•S

6.7.8 Call information on the SL3000 Sniffer line

- ▶  > Sniffer line

6.8 Log

6.8.1 Call the error and warning log

- ▶  > Logs > Errors and warnings

If there are more than 20 entries always the oldest entry is deleted.

6.8.2 Call calibration log

The entries are for the entire period of use of the device. If there are more than approx. 20 entries always the oldest entry is deleted.

- ▶  > Logs > Calibrations

6.8.3 Call maintenance log

- ▶  > Logs > Maintenance

If there are more than 20 entries always the oldest entry is deleted.

6.8.4 Call result log

To display test results in the operation modes “Auto Leak Test“ and “Vacuum”(Q_{max}).

If there are more than 50 entries always the oldest entry is deleted.

- ▶  > Logs > Result log



6.9 Device settings

6.9.1 Viewing and customizing individual parameters

You are able to get a quick overview of the actual settings of the device and you can make modifications, if needed.

- ✓ You have the required right to change the specific parameter.

- 1  > Parameter sets > Parameter list

- ⇒ The device settings will be displayed as a list.
 - 2 Modify individual parameters, if needed.
 - 3 Save .
- ▶ To modify parameters, press alternatively a subheading in the list. A separate setting window will be opened, where you can change and save.
- ⇒ After changing a parameter setting in a separate window press  to return to the list of parameters.

6.9.2 Saving and managing sets of parameters

A set of parameters is a collection of parameters with the relevant settings of the device. You are able to save sets of parameters in text-based files at any time. The parameters can be viewed in clearly arranged form.

✓  **Supervisor** rights

1  > Parameter sets > Manage parameter sets

⇒ Sets of parameters already created will be displayed as a list.

If the values of a saved set of parameters match the actual settings of the device 100 %, a green dot will be displayed.

2 To create a new set of parameters, press .

⇒ In the next window you can insert a free text description. The prefix “parameter-set” and the date of saving are used for the file name. Save .

You are able to save max 10 sets of parameters.

3 To open the context menu of a created set of parameters, press the desired set of parameter and choose

, to view further details concerning the parameters contained. If parameters do not match actual device settings, an orange dot will be displayed. If there is a missing setting, a red dot will be displayed (after a software update for example). We recommend to view the missing setting, to create a new set of parameters and to delete the old set of parameters.

, to activate a set of parameters.

, to delete a set of parameters.

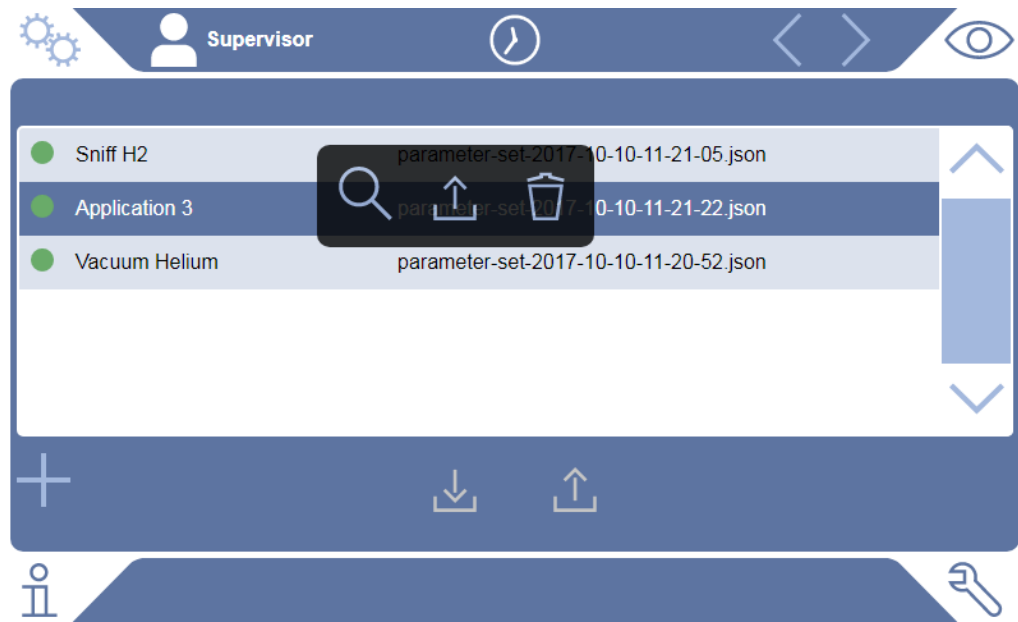

6.9.3 Exporting or importing sets of parameters

You are able to transfer saved sets of parameters from the internal memory to an attached USB flash drive and to import the sets again.

✓ **Supervisor** rights

- 1 > Parameter sets > Manage parameter sets
- 2 To export all sets of parameters to a USB flash drive (formatted in FAT32) if needed, press below the list.
- 3 To import all sets of parameters from a USB flash drive into the device, press below the list.
 - ⇒ All sets of parameters on the USB flash drive will be saved in the device, if the number of 10 is not exceeded. Using a PC you can delete redundant sets of parameters on the USB flash drive before transferring.
 - ⇒ You must not modify parameters of a set of parameters on the USB flash drive before importing. You cannot transfer these files to the device after the modification.

6.10 Updating the software

The device has two different software versions: One for the user interface and one for the basic unit. Each has its own independent versions number.

6.10.1 Update the user interface software

Import software updates using a USB flash drive.

NOTICE**Loss of data due to disconnection**

- ▶ Do not switch off the device and do not remove the USB flash drive while the software is being updated.

✓ **Supervisor rights**

- 1 Copy the file into the main directory of a FAT32 formatted USB flash drive.
 - 2 Connect the USB flash drive to a USB port on the device.
 - 3  > Update > Update operating unit
 - ⇒ At the top in the window the active software version of the user interface is shown.
If one or more versions of the software are on the USB flash drive the most recent version is shown on the line below. If this is the same as the version already installed the background is green, otherwise it is red.
 - 4 In order to load the new software version, press on the button "Update".
- ⇒ After completion there is an automatic restart of the operating unit.

6.10.2 Updating the software of the basic unit

Import software updates using a USB flash drive.

NOTICE**Loss of data due to disconnection**

- ▶ Do not switch off the device and do not remove the USB flash drive while the software is being updated.

✓ **Supervisor rights**

- 1 Copy the file into the main directory of a FAT32 formatted USB flash drive.
 - 2 Connect the USB flash drive to the USB port on the device.
 - 3  > Update > Update Basic Unit
 - ⇒ At the top in the window the active software version of the basic unit is shown.
If one or more versions of the software are on the USB flash drive the most recent version is shown on the line below. If this is the same as the version already installed the background is green, otherwise it is red.
 - 4 In order to load the new software version, press on the button "Update".
- ⇒ After completion there is an automatic restart of the system.

6.10.3 Update the software in expert mode

✓ **Supervisor** rights

1  > Update > Update operating unit/basic unit > Operating unit expert update

⇒ Software versions already available on the device are shown in a list.

2 Highlight any of the software versions as required and proceed to step 5.

⇒ Resetting to an older software version is possible.

3 If alternatively you want to add a new software version, connect a FAT32 formatted USB flash drive with the update file to one of the USB ports of the device.

4 In order to load the new software version, press on .

5 To activate the new version, select the desired list entry and press .

⇒ After completion there is an automatic restart of the system.

6.10.4 Activate additional function

If your leak detector offers the possibility, you can purchase one or more additional functions and activate them by means of an activation code.

✓ You have ordered an additional feature from the manufacturer specifying the serial number of your leak detector.

✓ You have received an unlock code from the manufacturer.

✓ **Supervisor** rights

1  > Update > Unlock feature

2 Enter your unlock code in the "Unlock code" field.

3 Save .

⇒ After successful unlock the new function will be displayed.



The unlocked function is not lost even if the factory settings are reset.

6.11 Use external monitor

You are able to use an external touch monitor instead of the internal monitor. You can use either the internal or the external monitor.

✓ You have a control unit with HDMI interface, for the illustration see "Control unit [▶ 23]".

✓ You have a touch monitor with connections for HDMI and USB, furthermore an appropriate power supply. HDMI is required to transmit the images, USB is required to transmit the sound.

- 1 Connect the HDMI cable and the USB cable of the touch monitor with the connector block of your leak detector, see also "Connections for accessories and control signals [▶ 31]". For proper operation, make sure that the cable length does not exceed 3 m.
- 2  > Display > Switch monitor
- 3 Press the "External Monitor" button.
⇒ The picture will be displayed on the external monitor.

Alternative procedure

- ▶ Instead of changing the monitor display, you can connect the external monitor before switching on the device.
⇒ Then the picture will be displayed on the external monitor without changing settings.

6.11.1 Switch back to the internal monitor

NOTICE

Disconnect external monitor

- ▶ If the device is turned on, switch to the internal monitor in the menu before disconnecting the connections of an external monitor.

When the instrument is switched on, you will be able to switch to internal monitor at any time.

- 1  > Display > Switch monitor
- 2 Press the "Internal Monitor" button.

6.12 View vacuum diagram

To check the function and the operating state of the measuring system at a glance, call up the simplified diagram of the vacuum diagram.

►  > Vacuum diagram

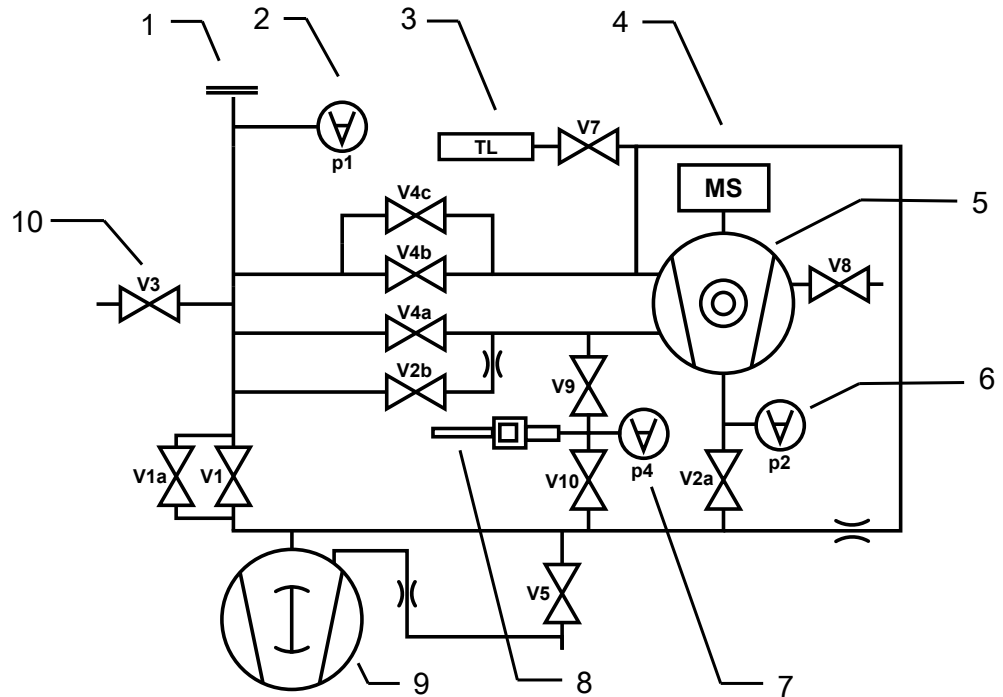

Fig. 14: The most important components of the vacuum diagram in UL3000 Fab ULTRA devices

1	Inlet flange	6	Fore-vacuum pressure gauge
2	Inlet pressure gauge	7	Pressure measuring point for flow monitoring
3	Internal calibration leak	8	Sniffer line
4	Mass spectrometer	9	Fore pump
5	Turbo molecular pump	10	V1 ... V10: Solenoid valves for controlling gas flows

6.13 Resetting to factory settings

You can restore the device to factory settings.



Loss of settings and measurement data

After resetting to factory settings only the manufacturer factory settings are in the memory of the device. The software of the device is not reset when restoring the factory settings.

✓  **Supervisor** rights

- 1  > Setup > General > Reset
- 2 Make your choice:
 - ⇒ If you want to reset all settings, press the "Reset settings" button.
 - ⇒ If you want to delete all recorded measurement data and user accounts, press the "Delete data" button.
 - ⇒ To reset the device to the factory settings, press both buttons one after the other.

6.14 Logging off from the device

- 1 Press your name, which is displayed in the upper left corner of the display, or select  > User accounts.
 - ⇒ The window "User accounts" opens. See also "Modify Personal Settings [▶ 55]".
- 2 You log off from the device via the button "Log off".
 - ⇒ The login window opens.

6.15 Switching off the device

NOTICE

Turbo molecular pump can be damaged

The running turbo molecular pump can be damaged by jerky movements or foreign objects.

- ▶ Avoid any jerking movements or vibrations to the device during operation and for up to 2 minutes after switching off.
- ▶ Prevent foreign objects from entering the inlet of the device.

You can switch off the device with the power supply switch at any time. The parameters set in the device remain saved.

7 Warning and error messages

During operation, the display shows information that helps you operate the device. Measurement values are displayed along with current device modes, operating instructions as well as warnings and error messages. The device is equipped with extensive self-diagnostic functions. If the electronics detect a faulty state, the device will show this as far as possible on the display and will interrupt operation when necessary. Warning and error messages consist of a number, a descriptive text, and often an associated measured value (e.g., a measured voltage).

Warnings

Warnings warn of device states that can impair the accuracy of measurements.

Operation of the instrument is not interrupted.

For details about the cause and the remedy, press .

To close a warning message, press the button "Clear" after reading.

Error messages

Errors are events that force the interruption of the operation.

For details about the cause and the remedy, press .

Once you have rectified the cause of the error, continue operation by pressing the button "Clear".

Active errors and warnings

This menu item is only displayed when the template contains errors or warnings:

▶  > Errors and warnings

Confirmed warnings

If an active warning is acknowledged without rectifying the cause, it is displayed under "Confirmed warnings".

▶  > Confirmed warnings

Reference on the display

An overview of possible errors and warnings can be found at:

▶  > Help > Errors and warnings

Special case

If the supply voltage falls below the permitted operating voltage range, see "Technical specifications [▶ 32]", the internal 24 V supply of the leak detector may fail while the backing pump continues to run anyway. This occurs very rarely.

- 1 If you do not see any indication in the display when the device is switched on and all LEDs on the device are also dark, switch the device off at the mains switch.
- 2 Have your mains voltage checked by a qualified electrician.
- 3 If the problem persists, contact customer service.

7.1 List of warning and error messages

Type	Notification	Possible sources of error	Remedy
W102	Timeout during communication with EEPROM on VI-Board	The EEPROM on the VI-Board is defective or does not exist	<ul style="list-style-type: none"> • Contact customer service
W104	One EEPROM parameter has been initialized	A new parameter was introduced by a software update	<ul style="list-style-type: none"> • Confirm the warning message • Check that the message does not appear when you restart the device • Check whether the factory setting of the new parameter corresponds to your application
		The EEPROM on the VI-Board is defective	<ul style="list-style-type: none"> • Confirm the warning message • Check if the message occurs each time when you restart the device • Contact customer service
W106	Several EEPROM parameters have been initialized	A software update introduced new parameters	<ul style="list-style-type: none"> • Confirm the warning message • Check that the message does not appear when you restart the device • Check whether the factory setting of the new parameters corresponds to your application
		The EEPROM on the VI-Board was replaced	<ul style="list-style-type: none"> • Confirm the warning message • Check that the message does not appear when you restart the device • Check whether the factory setting of the new parameters corresponds to your application
		The EEPROM on the VI-Board is defective	<ul style="list-style-type: none"> • Confirm the warning message • Check if the message occurs each time when you restart the device • Contact customer service
E107	Internal IIC communication error	Internal IIC communication error	<ul style="list-style-type: none"> • Contact customer service
E108	Internal IIC2 communication error	Internal IIC2 communication error	<ul style="list-style-type: none"> • Contact customer service
W109	Fehler der Echtzeituhr	Die Echtzeituhr ist möglicherweise defekt	<ul style="list-style-type: none"> • Contact customer service

Type	Notification	Possible sources of error	Remedy
W110	Real-time clock was reset! Enter date and time	The real-time clock has not been set	<ul style="list-style-type: none"> • Enter the correct date and time • Check that the message does not appear when you restart the device
		Battery jumper on the MSB not set	<ul style="list-style-type: none"> • Contact customer service
		Battery on MSB is discharged or defective	<ul style="list-style-type: none"> • Contact customer service
		Real-time clock defective	<ul style="list-style-type: none"> • Contact customer service
W111	Many EEPROM write cycles within the last 6 minutes	A very large number of write commands were issued through interfaces. Over time, this reduces the service life of the EEPROM.	<ul style="list-style-type: none"> • Remove the excess write accesses from your control program
E112	Impermissible DIP switch setting	The DIP switch on the MSB has an invalid position	<ul style="list-style-type: none"> • Contact customer service
		MSB defective	<ul style="list-style-type: none"> • Contact customer service
W113	The device ID does not match the recognized backing pump	The DIP switch on the MSB has an invalid position	<ul style="list-style-type: none"> • Contact customer service
		Type of backing pump was not or was incorrectly detected	<ul style="list-style-type: none"> • Contact customer service
		MSB defective	<ul style="list-style-type: none"> • Contact customer service
W122	No response from bus module	Connection to BUS module interrupted	<ul style="list-style-type: none"> • Check the connection to the bus module • Replace the connection cable to the bus module
		Bus module defective	<ul style="list-style-type: none"> • Replace the bus module
		Bus module connection on the device defective	<ul style="list-style-type: none"> • Contact customer service

Type	Notification	Possible sources of error	Remedy
W125	I/O module no longer connected	Connection to I/O module interrupted	<ul style="list-style-type: none"> • Check the connection to the I/O module • Replace the connection cable to the I/O module
		I/O module defective	<ul style="list-style-type: none"> • Replace the I/O module
		I/O module connection on the device defective	<ul style="list-style-type: none"> • Contact customer service
W127	Wrong bootloader version	The bootloader is not compatible with application	<ul style="list-style-type: none"> • Contact customer service
E129	EEPROM contains data from wrong device class	The software of the basic unit does not match the EEPROM	<ul style="list-style-type: none"> • Contact customer service
		The EEPROM does not match this device class	<ul style="list-style-type: none"> • Contact customer service
W130	Sniffer line not connected	The sniffer line cannot be addressed by the device	<ul style="list-style-type: none"> • Check the connection between sniffer line and the device (disconnect and reconnect) • Contact customer service
		Sniffer line defective	<ul style="list-style-type: none"> • Use another sniffer line, if possible • Contact customer service
W132	Sniffer line type (XL) not allowed	A sniffer line type (XL) cannot be used with this device	<ul style="list-style-type: none"> • Replace the sniffer line with a sniffer line type supported by the device
W151	No communication with operating unit	A software update or a parameter reset has been executed	<ul style="list-style-type: none"> • Confirm the warning message • Check that the message does not appear when you restart the device
		Internal connection problem between the basic unit and the operating unit	<ul style="list-style-type: none"> • Contact customer service
W152	No communication with control panel	Internal connection problem between the basic unit and the control panel	<ul style="list-style-type: none"> • Contact customer service

Type	Notification	Possible sources of error	Remedy
W153	Operating unit software version is obsolete	A more up-to-date operating unit software is available. For trouble-free operation, it is recommended to update the operating unit software.	<ul style="list-style-type: none"> • Contact the customer service for the latest operating unit software
E167	Run-up blocked, the 'Interlock' function is active	The dongle is not connected to the ACCESSORIES port	<ul style="list-style-type: none"> • Plug the dongle into the ACCESSORIES port
		The dongle connected to the ACCESSORIES port is defective	<ul style="list-style-type: none"> • Use another module if possible
		The 'Interlock' function was activated unintentionally	<ul style="list-style-type: none"> • Deactivate the 'Interlock' function
W171	CU1000 not supported	A CU1000 cannot be used with this device	<ul style="list-style-type: none"> • Disconnect the CU1000 from this device
W201	Voltage U24V_MSB too low	Malfunction of 24V power supply unit	<ul style="list-style-type: none"> • Contact customer service
		Short circuit or overload in the 24V supply	<ul style="list-style-type: none"> • Contact customer service
W202	Voltage U24V_MSB too high	Malfunction of 24V power supply unit	<ul style="list-style-type: none"> • Contact customer service
W203	24V valve supply voltage out of range	Malfunction of a valve	<ul style="list-style-type: none"> • Contact customer service
		Short circuit or overload in the 24V valve supply	<ul style="list-style-type: none"> • Contact customer service
W206	24V operating unit supply voltage out of range	Malfunction of operating unit	<ul style="list-style-type: none"> • Contact customer service
		Short circuit or overload in the 24V operating unit supply	<ul style="list-style-type: none"> • Contact customer service
W207	12V internal supply voltage out of range	Short circuit or overload in the 12V supply	<ul style="list-style-type: none"> • Contact customer service

Type	Notification	Possible sources of error	Remedy
W208	24V fan supply voltage out of range	Malfunction of a fan	• Contact customer service
		Short circuit or overload in the 24V fan supply	• Contact customer service
W209	24V DIV1 supply voltage out of range	Short circuit or overload in the 24V DIV1 supply	• Contact customer service
W210	24V DIV2 supply voltage out of range	Short circuit or overload in the 24V DIV2 supply	• Contact customer service
W211	5V internal supply voltage out of range	Short circuit or overload in the internal 5V supply	• Contact customer service
W212	5V sniffer line supply voltage out of range	Sniffer line defective	• Use another sniffer line, if possible • Contact customer service
		Short circuit or overload in the 5V sniffer line supply	• Contact customer service
W221	Internal voltage 24V_RC voltage out of range	The remote control is defective	• Use another remote control, if possible
		The cable connected to REMOTE CONTROL connector is defective	• Use another cable, if possible
		The accessory connected to ACCESSORIES connector is defective	• Use another accessory, if possible
		The cable connected to ACCESSORIES connector is defective	• Use another cable, if possible
		Short circuit or overload in the 24V_RC supply	• Contact customer service

Type	Notification	Possible sources of error	Remedy
W222	Internal voltage 24V_IO voltage out of range	The module connected to LD connector is defective	• Use another module, if possible
		The cable connected to LD connector is defective	• Use another cable, if possible
		Short circuit or overload in the 24V_IO supply	• Contact customer service
W223	Internal voltage 24V_TMP1 voltage out of range	Short circuit or overload in the 24V_TMP1 supply	• Contact customer service
W224	Internal voltage 24V_PRESSURE (Pirani) voltage out of range	Short circuit or overload in the 24V_PRESSURE (Pirani) supply	• Contact customer service
W240	Voltage +15V out of range	Short circuit at preamplifier	• Contact customer service
		VI-Board or MSB defective	• Contact customer service
W241	Voltage -15V out of range	Short circuit at preamplifier	• Contact customer service
		VI-Board or MSB defective	• Contact customer service
E242	+15V or -15V voltage shorted	Short circuit at preamplifier	• Contact customer service
		VI-Board or MSB defective	• Contact customer service
W250	REF5V voltage out of range	Short circuit at preamplifier	• Contact customer service
		VI-Board or MSB defective	• Contact customer service
E252	REF5V voltage shorted	Short circuit at preamplifier	• Contact customer service
		VI-Board or MSB defective	• Contact customer service

Type	Notification	Possible sources of error	Remedy
W254	Valve current is out of range	One or more lowered valves are not connected or defective	• Contact customer service
		VI-Board or MSB defective	• Contact customer service
W255	Fan current is out of range	Fan not connected	• Contact customer service
		Fan blocked or defective	• Contact customer service
W300	Anode voltage too low	Short circuit of the anode voltage	• Contact customer service
		VI-Board or MSB defective	• Contact customer service
W301	Anode voltage too high	MSB defective	• Contact customer service
W302	Suppressor voltage too low	Short circuit of suppressor or preamplifier	• Contact customer service
		VI-Board or MSB defective	• Contact customer service
W303	Suppressor voltage too high	MSB defective	• Contact customer service
W304	Anode-cathode voltage too low	Short circuit between anode and cathode	• Contact customer service
		VI-Board or MSB defective	• Contact customer service
W305	Anode-cathode voltage too high	MSB defective	• Contact customer service
E306	Anode voltage incorrect	The anode voltage set value is outside the allowable range	• Perform a calibration • Contact customer service
		MSB defective	• Contact customer service
W310	Cathode 1 broken	Cathode defective	• Check that the other cathode has been switched on • Contact customer service
		Connection to cathode broken	• Contact customer service
		VI-Board or MSB defective	• Contact customer service

Type	Notification	Possible sources of error	Remedy
W311	Cathode 2 broken	Cathode defective	<ul style="list-style-type: none"> • Check that the other cathode has been switched on • Contact customer service
		Connection to cathode broken	<ul style="list-style-type: none"> • Contact customer service
		VI-Board or MSB defective	<ul style="list-style-type: none"> • Contact customer service
E312	Cathodes broken	Both cathodes defective	<ul style="list-style-type: none"> • Contact customer service
		Connection to cathode broken	<ul style="list-style-type: none"> • Contact customer service
		VI-Board or MSB defective	<ul style="list-style-type: none"> • Contact customer service
E340	Emission error	Pressure too high with aged cathode	<ul style="list-style-type: none"> • Contact customer service
W342	Cathodes not connected	Both cathodes defective during self-test	<ul style="list-style-type: none"> • Contact customer service
		Plug of ion source not connected	<ul style="list-style-type: none"> • Contact customer service
W350	Suppressor not connected	Suppressor cable not connected or defective	<ul style="list-style-type: none"> • Contact customer service
E352	Preamplifier not connected	Preamplifier defective or cable not connected	<ul style="list-style-type: none"> • Contact customer service
W358	Alternate preamplifier ranges	Preamplifier defective	<ul style="list-style-type: none"> • Contact customer service
		Unusual leak rate waveform	<ul style="list-style-type: none"> • Contact customer service
W359	Overdriven preamplifier	Mass spectrometer contaminated	<ul style="list-style-type: none"> • Check the tightness of the connection between the leak detector and the test object • Reduce contamination in the environment where the device is located • Use the 'Regeneration' function in the 'Vacuum' operation mode
		Ion source or preamplifier defective	<ul style="list-style-type: none"> • Contact customer service

Type	Notification	Possible sources of error	Remedy
W360	Preamplifier output signal too low	Ion source defective	• Contact customer service
		Mass spectrometer contaminated	• Contact customer service
W361	The offset voltage of the preamplifier is too high	Preamplifier defective	• Contact customer service
W362	Preamplifier range error	Preamplifier defective	• Contact customer service
		MSB defective	• Contact customer service
W374	Background in stand-by out of range	Mass spectrometer contaminated	<ul style="list-style-type: none"> • Check the tightness of the connection between the leak detector and the test object • Reduce contamination in the environment where the device is located • Use the 'Regeneration' function in the 'Vacuum' operation mode
		Ion source or preamplifier defective	• Contact customer service
W390	500 GOhm amplifier resistor out of range	Preamplifier defective	• Contact customer service
		MSB defective	• Contact customer service
E400	TMP error message	Unhandled error message from the TMP	• Contact customer service
W401	TMP warning message	Unhandled warning message from the TMP	• Contact customer service
E402	No communication with turbo pump converter	TMP cable defective or not connected	• Contact customer service
		TMP converter defective	• Contact customer service
		MSB defective	• Contact customer service
E404	TMP current consumption too high	Pressure in the TMP is too high	• Contact customer service
W405	No TMP run-up	Inlet pressure during run-up too high	<ul style="list-style-type: none"> • Check that the backing pump is working during run-up • Check that the pressure drops during run-up • Contact customer service
		TMP bearing damage	• Contact customer service

Type	Notification	Possible sources of error	Remedy
W406	Unzulässiger TMP-Subtyp	Type of TMP pump was not or was incorrectly detected	<ul style="list-style-type: none"> • Contact customer service
E410	TMP temperature too high	The ambient temperature is too high	<ul style="list-style-type: none"> • Turn off the device and let it cool down • Reduce the temperature in the environment where the device is located
		Air filter dirty	<ul style="list-style-type: none"> • Clean the air vents or replace the filter plates
		Fan blocked or defective	<ul style="list-style-type: none"> • Contact customer service
W411	High TMP temperature	The ambient temperature is too high	<ul style="list-style-type: none"> • Reduce the temperature in the environment where the device is located
		Air filter dirty	<ul style="list-style-type: none"> • Clean the air vents or replace the filter plates
		Fan blocked or defective	<ul style="list-style-type: none"> • Contact customer service
W421	TMP voltage too low	Power supply to TMP not sufficient	<ul style="list-style-type: none"> • Contact customer service
E422	No TMP run-up	Inlet pressure during run-up too high	<ul style="list-style-type: none"> • Check that the backing pump is working during run-up • Check that the pressure drops during run-up • Contact customer service
		TMP bearing damage	<ul style="list-style-type: none"> • Contact customer service
E423	TMP pressure rise	Inrush of air into TMP	<ul style="list-style-type: none"> • Contact customer service
W449	Soft start of TMP2 required	The TMP2 has not been activated for a long time or has not been running for a long time	<ul style="list-style-type: none"> • Wait until the soft start has been completed. This requires the TMP2 to run continuously for several minutes. During this time, you can continue measuring with reduced helium suction capacity, as the speed of the TMP2 is only increased slowly. The soft start is completed when the status of the TMP2 changes to 'Normal' for the first time after this message (see TMP2 information page).

Type	Notification	Possible sources of error	Remedy
E450	Temperature of TMP2 converter too high	The ambient temperature is too high	<ul style="list-style-type: none"> • Reduce the temperature in the environment where the device is located
		Fan blocked or defective	<ul style="list-style-type: none"> • Contact customer service
		TMP2 converter defective	<ul style="list-style-type: none"> • Contact customer service
E451	Temperature prewarning of backing pump	The ambient temperature is too high	<ul style="list-style-type: none"> • Reduce the temperature in the environment where the device is located
		Ambient temperature is too low	<ul style="list-style-type: none"> • Increase the temperature in the environment where the device is located
		Fan blocked or defective	<ul style="list-style-type: none"> • Contact customer service
		Temperature sensor of backing pump is defective	<ul style="list-style-type: none"> • Contact customer service
W452	No communication with backing pump	Backing pump control cable defective or not connected	<ul style="list-style-type: none"> • Contact customer service
		Backing pump has no power supply	<ul style="list-style-type: none"> • Contact customer service
		Backing pump converter defective	<ul style="list-style-type: none"> • Contact customer service
		VI-Board or MSB defective	<ul style="list-style-type: none"> • Contact customer service
E453	Backing pump failure	Unhandled error message from the backing pump	<ul style="list-style-type: none"> • Contact customer service
E454	Fault in backing pump: Undervoltage	The backing pump in the leak detector has insufficient mains input voltage	<ul style="list-style-type: none"> • Make sure that you use the supplied power cord • Have your mains voltage installation checked by a qualified electrician.
		Backing pump converter defective	<ul style="list-style-type: none"> • Contact customer service
W455	Backing pump rotation speed too low	No run-up of backing pump	<ul style="list-style-type: none"> • Contact customer service

Type	Notification	Possible sources of error	Remedy
W456	Operation of the backing pump is locked	The plug at connection P1 of the frequency converter of the backing pump is defective or not connected	<ul style="list-style-type: none"> • Contact customer service
E457	Fault in backing pump: Power failure	The backing pump in the leak detector has a faulty mains input voltage	<ul style="list-style-type: none"> • Make sure that you use the supplied power cord • Visually inspect the power cord for damage • Have your mains voltage installation checked by a qualified electrician.
W458	The backing pump is not started because it is too cold. Delete the warning at your own risk to start the pump.	Ambient temperature is too low	<ul style="list-style-type: none"> • Increase the temperature in the environment where the device is located • If you bring the leak detector inside from a cold outside area, wait for at least an hour before you switch on the leak detector
		Temperature sensor of backing pump is defective	<ul style="list-style-type: none"> • Contact customer service
		Backing pump converter defective	<ul style="list-style-type: none"> • Contact customer service
W459	Run-up of backing pump takes too long	Exhaust connection sealed	<ul style="list-style-type: none"> • Make sure that the exhaust hose is correctly connected
		Backing pump defective	<ul style="list-style-type: none"> • Contact customer service
W460	No communication with the TMP2 converter	TMP2 cable defective or not connected	<ul style="list-style-type: none"> • Contact customer service
		TMP2 converter defective	<ul style="list-style-type: none"> • Contact customer service
		MSB defective	<ul style="list-style-type: none"> • Contact customer service
E461	Unhandled error message of TMP2	TMP2 converter defective	<ul style="list-style-type: none"> • Contact customer service
		TMP2 defective	<ul style="list-style-type: none"> • Contact customer service

Type	Notification	Possible sources of error	Remedy
E462	Temperature of TMP2 pump too high	The ambient temperature is too high	<ul style="list-style-type: none"> Reduce the temperature in the environment where the device is located
		Fan blocked or defective	<ul style="list-style-type: none"> Contact customer service
		TMP2 defective	<ul style="list-style-type: none"> Contact customer service
E463	Temperature error of backing pump	The ambient temperature is too high	<ul style="list-style-type: none"> Reduce the temperature in the environment where the device is located
		Fan blocked or defective	<ul style="list-style-type: none"> Contact customer service
		Ambient temperature is too low	<ul style="list-style-type: none"> Increase the temperature in the environment where the device is located
		Temperature sensor of backing pump is defective	<ul style="list-style-type: none"> Contact customer service
E464	Power consumption of backing pump too high	Exhaust connection sealed	<ul style="list-style-type: none"> Make sure that the exhaust hose is correctly connected
		Heavy duty operation	<ul style="list-style-type: none"> Contact customer service
E465	Incorrect flow direction in backing pump	Gas flow into device due to pressure at exhaust connection	<ul style="list-style-type: none"> Remove the pressure from the exhaust connection
E466	Run-up error of backing pump / rotation speed too low	Exhaust connection sealed	<ul style="list-style-type: none"> Make sure that the exhaust hose is correctly connected
		Backing pump defective	<ul style="list-style-type: none"> Contact customer service
E467	Overload protection of backing pump	Exhaust connection sealed	<ul style="list-style-type: none"> Make sure that the exhaust hose is correctly connected
		Backing pump defective	<ul style="list-style-type: none"> Contact customer service
W468	Unhandled warning message of backing pump	Unhandled error message from the backing pump	<ul style="list-style-type: none"> Contact customer service
E500	Pressure sensor p1 not connected	Pressure sensor not connected or cable defective	<ul style="list-style-type: none"> Contact customer service
		VI-Board or MSB defective	<ul style="list-style-type: none"> Contact customer service

Type	Notification	Possible sources of error	Remedy
E502	Pressure sensor p2 not connected	Pressure sensor not connected or cable defective	• Contact customer service
		VI-Board or MSB defective	• Contact customer service
E504	Pressure sensor p3 not connected	Pressure sensor not connected or cable defective	• Contact customer service
		VI-Board or MSB defective	• Contact customer service
E505	Pressure sensor p4 not connected	Pressure sensor p4 is not inserted into the VI-Board	• Contact customer service
		VI-Board or MSB defective	• Contact customer service
W509	No communication with pressure sensor p5	Pressure sensor not connected or cable defective	• Contact customer service
		VI-Board or MSB defective	• Contact customer service
E520	Pressure too high	Pressure p2 too high for at least 15s	• Contact customer service
E521	Pressure rise, anode voltage collapsed	Pressure rise at pressure sensor p2 and anode voltage collapsed	• Contact customer service
W522	Pressure rise, emission collapsed	Pressure rise at pressure sensor p2 and emission collapsed	• Contact customer service
W540	Flow through capillary is too low! Leaks may not be detectable	Filter is dirty	• Replace the sniffer tip filter
		Sniffer tip or capillary blocked	• Remove the blocking of the sniffer tip • Use another sniffer line, if possible • Contact customer service
		The pressure limit for a blocked capillary is set too high	• Check and change the pressure limit, if necessary

Type	Notification	Possible sources of error	Remedy
W541	Flow through capillary is much too low! Leaks may not be detectable	Filter is dirty	<ul style="list-style-type: none"> • Replace the sniffer tip filter
		Sniffer tip or capillary blocked	<ul style="list-style-type: none"> • Remove the blocking of the sniffer tip • Use another sniffer line, if possible • Contact customer service
		The pressure limit for a blocked capillary is set too high	<ul style="list-style-type: none"> • Check and change the pressure limit, if necessary
W542	Flow through capillary too high	Capillary broken or leaky	<ul style="list-style-type: none"> • Use another sniffer line, if possible • Contact customer service
		The pressure limit for a broken capillary is set too low	<ul style="list-style-type: none"> • Check and change the pressure limit, if necessary
W559	Leak rate too high! Switched to the standby mode to prevent contamination!	Gross leak at test object or the connection to the test object	<ul style="list-style-type: none"> • Check the tightness of the connection between the leak detector and the test object
		Gross leak protection limit is set too low	<ul style="list-style-type: none"> • Check and change the gross leak protection limit, if necessary
		Audio alarm delay time set too short	<ul style="list-style-type: none"> • Check and change the audio alarm delay, if necessary
W580	Maximum evacuation time until 100 mbar exceeded	Gross leak at test object or the connection to the test object	<ul style="list-style-type: none"> • Check the tightness of the connection between the leak detector and the test object • Use another test object, if possible
		The settings value for the max. gross leak evacuation time is too low	<ul style="list-style-type: none"> • Check and change the max. gross leak evacuation time if necessary
W581	Maximum evacuation time until measurement exceeded	Gross leak at test object or the connection to the test object	<ul style="list-style-type: none"> • Check the tightness of the connection between the leak detector and the test object • Use another test object, if possible
		The settings value for the max. evacuation time until measurement is too low	<ul style="list-style-type: none"> • Check and change the max. evacuation time until measurement if necessary

Type	Notification	Possible sources of error	Remedy
W618	I•BOOST leak rate dropped faster than expected (5 s message)	The 'I•BOOST time constant' for the connected vacuum system has not yet been determined or something has been changed on the connected vacuum system after determining the 'I•BOOST time constant'	<ul style="list-style-type: none"> Perform the procedure for determining the 'I•BOOST time constant' again
W619	I•BOOST leak rate dropped faster than expected (30 s message)	The 'I•BOOST time constant' for the connected vacuum system has not yet been determined or something has been changed on the connected vacuum system after determining the 'I•BOOST time constant'	<ul style="list-style-type: none"> Perform the procedure for determining the 'I•BOOST time constant' again
W625	Leak rate of internal calibration leak not yet set	EEPROM parameter was reset	<ul style="list-style-type: none"> Enter the correct leak rate for the internal calibration leak

Type	Notification	Possible sources of error	Remedy
W630	Calibration request	Operation mode or mass has changed	• Perform a calibration
		HYDRO•S has been switched on (if function available)	• Perform a calibration
		Auto Leak Test is active and testing time has changed	• Perform a calibration
		A new SL3000 sniffer line has been connected (if function available)	• Perform a calibration
		Runtime over 30 minutes and temperature change by 5 Kelvin since last calibration	• Perform a calibration
		Runtime over 30 minutes and no calibration for 24 hours	• Perform a calibration
W640	Auto Leak Test: Too many consecutive tests failed	Leak rate setpoint 1 does not match the test object	• Check and change the leak rate setpoint 1 if necessary
		Test chamber leaky	• Use another test chamber, if possible
W670	Calibration error (emission collapsed)	During calibration the emission collapsed	<ul style="list-style-type: none"> • Check if the message occurs again when you perform a new calibration • Contact customer service
W700	Pre-amplifier temperature is too low	Ambient temperature is too low	• Increase the temperature in the environment where the device is located
		Temperature sensor is defective	• Contact customer service
W702	Pre-amplifier temperature is too high	The ambient temperature is too high	• Reduce the temperature in the environment where the device is located
		Air filter dirty	• Clean the air vents or replace the filter plates
		Fan blocked or defective	• Contact customer service

Type	Notification	Possible sources of error	Remedy
E709	MSB temperature is too low	Ambient temperature is too low	<ul style="list-style-type: none"> • Increase the temperature in the environment where the device is located
		Temperature sensor is defective	<ul style="list-style-type: none"> • Contact customer service
W710	MSB temperature is too high	The ambient temperature is too high	<ul style="list-style-type: none"> • Reduce the temperature in the environment where the device is located
		Air filter dirty	<ul style="list-style-type: none"> • Clean the air vents or replace the filter plates
		Fan blocked or defective	<ul style="list-style-type: none"> • Contact customer service
E711	Max. MSB temperature exceeded	The ambient temperature is too high	<ul style="list-style-type: none"> • Reduce the temperature in the environment where the device is located
		Air filter dirty	<ul style="list-style-type: none"> • Clean the air vents or replace the filter plates
		Fan blocked or defective	<ul style="list-style-type: none"> • Contact customer service
W901	Maintenance: TMP bearing/lubricant	Maintenance interval for TMP bearing/lubricant exceeded	<ul style="list-style-type: none"> • Contact customer service
W903	Maintenance: Calibration leak expired	Maintenance interval for calibration leak exceeded	<ul style="list-style-type: none"> • Contact customer service
W904	Maintenance: Sniffer tip filter	Maintenance interval for sniffer tip filter exceeded	<ul style="list-style-type: none"> • Contact customer service
W910	Maintenance: Backing pump	Maintenance interval for backing pump exceeded	<ul style="list-style-type: none"> • Contact customer service
W920	Maintenance: Exhaust filter	Maintenance interval for exhaust filter exceeded	<ul style="list-style-type: none"> • Contact customer service
W925	Maintenance: Air filter	Maintenance interval for air filter exceeded	<ul style="list-style-type: none"> • Contact customer service

8 Cleaning and maintenance

All cleaning and maintenance work described here must be carried out without opening the device!



⚠ DANGER

Risk of death from electric shock

There are high voltages inside the device. Touching parts where electrical voltage is present can result in death.

- ▶ Disconnect the device from the power supply prior to any cleaning and maintenance work. Ensure that the electrical supply cannot be switched back on unintentionally.
- ▶ Don't open the device!

8.1 Cleaning the housing

Wipe the housing with a soft damp cloth.

Use only water to moisten. Avoid cleaners that contain alcohol, fat or oil.

8.2 Change the filter mat inside the tool box

Filter mat tool box	
Required tools	None

Depending on the location, the filter mat in the tool box can become dirty. Check the filter mat periodically and change it, if the filter mat is significant dirty.

- ✓ They consist of a new filter mat.
 - 1 Make sure that the device is disconnected from the power supply by pulling the power plug securely.
 - 2 Open the tool box with the delivered key.
 - 3 Remove the plastic grid. It is attached only by locking lugs.



- 4 Remove the used air filter from the plastic grid and insert a new one.
- 5 Refit the plastic grid together with the new air filter.

8.3 Replacement of the filter mat on the bottom of the device

Filter mat bottom of the device	
Required tools	Screwdriver

Check the filter mat periodically and change it, if the filter mat is significant dirty.

✓ They consist of a new filter mat.

- 1 Make sure that the device is disconnected from the power supply by pulling the power plug securely.
- 2 To reach the filter mat, loosen the knurled screw on the front of the device at the bottom.



- 3 Remove the metal sheet with the filter mat. The metal sheet can be pulled out more easily by holding it in an inclined position.



- 4** Loosen the screws, which fix the filter mat on the metal sheet.
- 5** Replace the filter mat.
- 6** Secure the filter mat with the screws, insert the metal sheet and fix it with the knurled screw.

8.4 Replacing the SL200 sniffer line filter

Structure of the sniffer tip

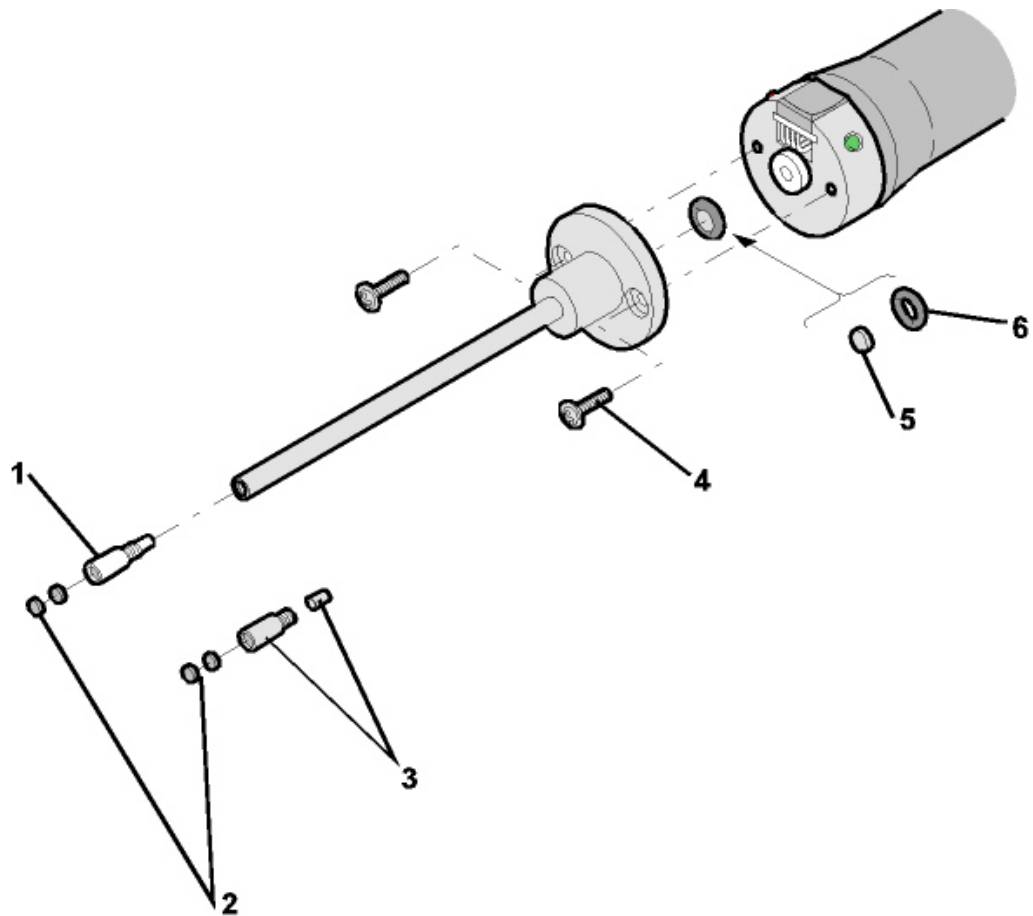

Fig. 15: Sniffer tip

1	Capillary filter (plastic; standard)	4	Cross-head screws
2	Felt pads	5	Sinter filter
3	Capillary filter (metal with gasket; option)	6	Gasket

A blockage of the sniffer tip can have the following causes:

Capillary filter blocked -> replace felt discs or capillary filter

Sinter filter clogged -> check or replace sinter filter

Capillary clogged in sniffer tip -> replace sniffer tip

Sniffer tip damaged -> replace sniffer tip

Sniffer line damaged / blocked -> replace SL 200.

Replace felt discs or capillary filters

- Switch off the leak detector or disconnect the sniffer line from the device.
- Use tweezers to remove the dirty felt discs and replace them with new ones.

or

- Unscrew the capillary filter and replace it with a new one. Do not forget the gasket for the metal version!

Check or replace the sinter filter

- 1 Switch off the leak detector or disconnect the sniffer line from the device.
- 2 Remove the two cross-head screws.
- 3 Remove the sinter filter with gasket.
- 4 Check the filter optically for soiling.
 - ⇒ If you do not see any soiling or only slight soiling, continue to use the sinter filter including gasket.

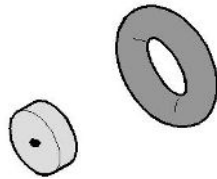

Fig. 16: Sintered filter slightly soiled

- ⇒ With heavy soiling, replace sinter filter including gasket.

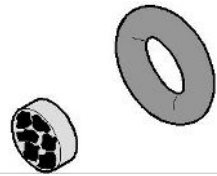

Fig. 17: Sintered filter heavily soiled

- 5 Tighten the sniffer tip again.
 - ⇒ The sniffer line is ready to be used again.

If you have activated the display of maintenance requests, set the maintenance interval to the desired new period. Also see "Activate or deactivate maintenance requests [▶ 64]" and "Set maintenance interval "Filter sniffer tip" or "Air filter" [▶ 63]".

8.5 Replacing the SL3000 sniffer line filter

Replacing the filter inserts of the capillary filter and the water conservation tip

The plastic capillary filter, the metal capillary filter and the water conservation tip are equipped with filter inserts.

There is a plugwasher below the metal capillary filter and the water conservation tip. This seal is already integrated into the plastic capillary filter.

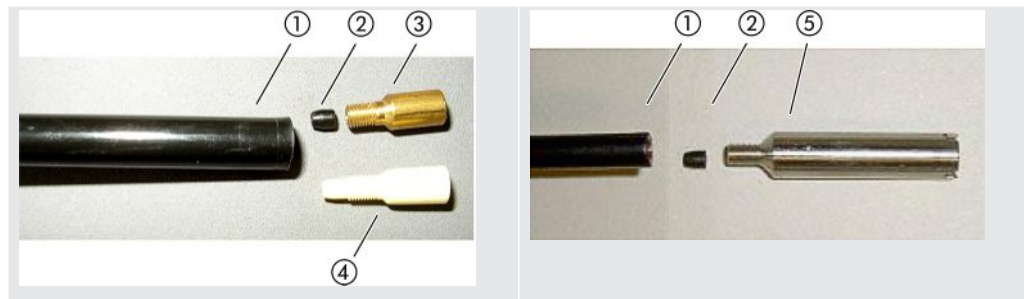

Table 3: Capillary filter

1	Sniffer line end	4	Plastic capillary filter
2	cone seal	5	Water conservation tip
3	Metal capillary filter		

Capillary filter and water conservation tip are screwed onto the sniffer line end. The filter inserts are inserted and lie in front of a small metal grill that is also inserted.

To replace the filter inserts, proceed as follows:

- 1 Switch off the leak detector.
- 2 Unscrew the capillary filter or the water conservation tip. Make sure that the cone seal does not fall out.
- 3 Push out the old filter pads and the metal grill from the rear.

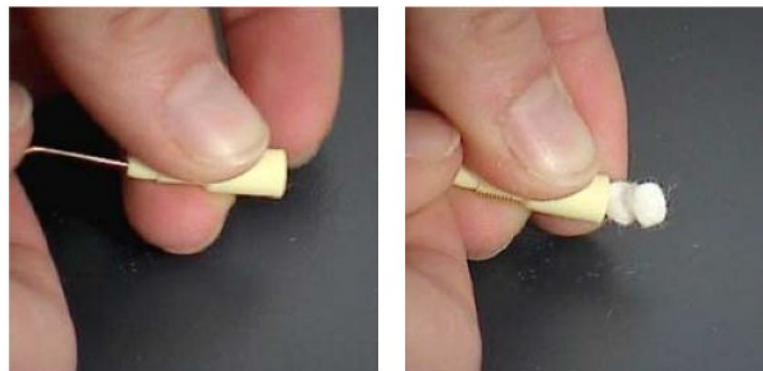

Fig. 18: Pressing the filter inserts out of the capillary filter

- 4 Dispose of the old inserts and clean the metal grill.
- 5 Push the metal grill and then the two new inserts into the filter from the front. Make sure that grill and inserts do not cant.
- 6 Switch on the leak detector.
- 7 Close the sniffer probe with your finger. With the water protection tip, you have to also cover the opening on the side. You should then be able to feel a negative pressure. If not then there is a leak somewhere and you have to check the screw connection. The cone seal may also have fallen out.
- 8 If you have activated the display of maintenance requests, set the maintenance interval to the desired new period. Also see "Activate or deactivate maintenance requests [▶ 64]" and "Set maintenance interval "Filter sniffer tip" or "Air filter" [▶ 63]".

Replacing the sinter filter of the sniffer handle

The sinter filter is in the sniffer handle. To replace the filter inserts, proceed as follows:

- 1 Switch off the leak detector.
- 2 Unscrew the two cross-head screws that hold the sniffer probe in place.
- 3 Remove sinter filter including o-ring.



Fig. 19: Sinter filter in the sniffer handle

- 4 Check the filter for visible soiling.
- 5 Insert a new sinter filter with o-ring in the base of the filter tip.
- 6 Tighten the sniffer tip again.
- 7 Switch on the leak detector.
- 8 Close the sniffer probe with your finger. You should be able to feel the underpressure. If not then there is a leak somewhere and you have to check sniffer probe and handle.
- 9 If necessary, set the maintenance interval to the desired new period. See also "Set maintenance interval "Filter sniffer tip" or "Air filter" [[▶ 63](#)]".

8.6 Mounting or changing the gas cylinder

Observe the following notes when using the optionally available cylinder holder:

⚠ WARNING**Risk of injury due to improper mounting of a gas cylinder on the mobile leak detector**

- ▶ When mounting the bottle holder on the leak detector, follow the sequence of action steps as described in the separate mounting instructions.
- ▶ Mount the base of the cylinder holder flush with the gas cylinder.
- ▶ In order not to impair the stability of the leak detector, transport only small to medium-sized cylinders (maximum 10 l, maximum cylinder size including protective cap 98 cm, 200 bar).
- ▶ Check the supplied tensioning straps for visible damage.
- ▶ Always secure the bottle on the bottle holder with both tension straps.
- ▶ Make sure that any connected spray hose is never under tension.
- ▶ Observe the manufacturer's safety instructions for handling gas cylinders.

8.7 Creating screenshots

You can save the current screen contents of the device to an image file. You can use such a file for service communication, for example.

- 1 Create a directory named "Screenshots" on a USB stick (FAT 32 formatted).
- 2 To take a screenshot, connect the USB stick to one of the USB ports of the leak detector, see also the back of the "Control unit [▶ 23]".
 - ⇒ A screenshot is automatically taken and stored in the directory on the USB stick. The date and time are also saved.
- 3 To take another screenshot, disconnect the USB stick from the USB port and then reconnect it to the leak detector.
 - ⇒ A screenshot saved earlier will not be overwritten when another screenshot is taken.

8.8 Have the device serviced or repaired

**⚠ WARNING****Danger due to harmful substances**

Contaminated devices could endanger health. The contamination declaration serves to protect all persons who come into contact with the device.

- ▶ Fill in the declaration of contamination completely.

Maintenance inside the device should only be performed by the manufacturer. We recommend having the device serviced every 4000 hours or annually.

You can send in your device to INFICON so it can be maintained or repaired. For further details see "Returning the device for maintenance, repair or disposal [[▶ 126](#)]".

8.9 Maintenance plan

Assembly	Maintenance work	Operating hours / years					Service level	Spare part number
		1500	4000	8000	16000	24000		
		1/4	1	2	3	4		
Vacuum system								
NeoDry backing pump	Check performance		X	X	X	X	II	
	Replace pump if necessary		X ₃	X ₃	X	X ₃	III	200009420 200009420R
Devices up to and including 3/2024 (type plate): TMP Pfeiffer SF80 *)	Changing the oil wick cartridge			X ₃			II	200003801
	Change bearings and replace oil wick cartridge					X ₂	III	200003800 200003800R
Devices as of 4/2024 (type plate): TMP SHIMADZU BT70	Check performance - if necessary: Return TMP for preventive overhaul			X ₃			III	
	Exchange TMP Return shipment of TMP for overhaul					X	III	200012580 200012580R
Valve block	Clean valves		X ₃	X	X	X	III	
	Replace valve seals		X ₃	X	X	X	III	200010545
	Dismantle and clean the valve block			X ₃	X	X ₃	III	
Flood and purge gas line	Renew filter		X ₃	X ₁	X ₁	X ₁	II	200000683 200001095
	Electrical							
Fan subassemblies	Blow out fan chassis and TMP	X ₃	X ₁	X ₁	X ₁	X ₁	II	
	Check air filter kit and replace if necessary	X ₃	X ₁	X ₁	X ₁	X ₁	I	200007656
Subassemblies and accessories								
Sniffer line SL3000	Renew filter	X ₃ - Perform sniffer operation every 1000 hours					I	200001116 20003500
	Recalibration / replacement	X ₂ - Perform depending on the expiration date					III	14030

Maintenance schedule legend

*) In the event of replacement, a Pfeiffer SplitFlow 80 turbomolecular pump will be used again for an appliance up to and including 3/2024.

- I Customer or higher level
- II Customer with instruction or higher level
- III INFICON Service Technician
- X Carry out maintenance as per operating hours or duration
- X₁ Maintenance after operating hours, not after duration
- X₂ Maintenance by duration, not by operating hours
- X₃ Dependent on environmental influences, operating conditions, contamination and application process

To the Kashiwama NeoDry backing pump

When pumping clean gases such as dry air and inert gases, the recommended schedule for preventive maintenance is 3 years.

When pumping condensable gases such as water vapour and gas-mixed solvents as well as aggressive or corrosive gases, it may be necessary to reduce the maintenance interval to one year.

The recommendation is made to maintain the technical specifications of the pump specified by the manufacturer throughout the life of the device. Lack of maintenance will not normally result in a sudden failure of the pump. Due to wear, pressure performance will decrease over time.

As long as the pressure performance is suitable for the customer application, the replacement interval can be changed according to the customer's request.

About devices with I•RISE

Devices with built-in I•RISE function do not require any additional maintenance under clean working conditions.

9 Decommissioning the measuring instrument

9.1 Disposing of the device

The device can either be disposed of by the operator or be sent to the manufacturer. The device consists of materials that can be recycled. This option should be exercised to prevent waste and also to protect the environment.

During disposal, observe the environmental and safety regulations of your country.



Device cannot be scrapped with the normal domestic waste.

9.2 Returning the device for maintenance, repair or disposal



WARNING

Danger due to harmful substances

Contaminated devices could endanger health. The contamination declaration serves to protect all persons who come into contact with the device. Devices sent in without a return number and completed contamination declaration will be returned to the sender by the manufacturer.

► Fill in the declaration of contamination completely.

- 1 Contact the manufacturer and send in a completed declaration of contamination before return shipment.
⇒ You will then receive a return number and the shipping address.
- 2 Use the original packaging when returning.
- 3 Before shipping the instrument, attach a copy of the completed contamination declaration to the outside of the package.

For contamination declaration see below.

Declaration of Contamination

The service, repair, and/or disposal of vacuum equipment and components will only be carried out if a correctly completed declaration has been submitted. Non-completion will result in delay.
 This declaration may only be completed (in block letters) and signed by authorized and qualified staff.

1 Description of product

Type _____

Article Number _____

Serial Number _____

2 Reason for return

3 Operating fluid(s) used (Must be drained before shipping.)

4 Process related contamination of product:

toxic	no <input type="checkbox"/> 1)	yes <input type="checkbox"/>	<p>2) Products thus contaminated will not be accepted without written evidence of decontamination!</p>
caustic	no <input type="checkbox"/> 1)	yes <input type="checkbox"/>	
biological hazard	no <input type="checkbox"/>	yes <input type="checkbox"/> 2)	
explosive	no <input type="checkbox"/>	yes <input type="checkbox"/> 2)	
radioactive	no <input type="checkbox"/>	yes <input type="checkbox"/> 2)	
other harmful substances	no <input type="checkbox"/> 1)	yes <input type="checkbox"/>	

The product is free of any substances which are damaging to health yes

1) or not containing any amount of hazardous residues that exceed the permissible exposure limits

5 Harmful substances, gases and/or by-products

Please list all substances, gases, and by-products which the product may have come into contact with:

Trade/product name	Chemical name (or symbol)	Precautions associated with substance	Action if human contact

6 Legally binding declaration:

I/we hereby declare that the information on this form is complete and accurate and that I/we will assume any further costs that may arise. The contaminated product will be dispatched in accordance with the applicable regulations.

Organization/company _____

Address _____ Post code, place _____

Phone _____ Fax _____

Email _____

Name _____

Date and legally binding signature _____ Company stamp _____

Copies:
 Original for addressee - 1 copy for accompanying documents - 1 copy for file of sender

10 Accessories and interfaces

10.1 Accessories and spare parts

The parts listed below can additionally be ordered:

Bus module	
BM1000 PROFIBUS	560-315
BM1000 PROFINET IO	560-316
BM1000 DeviceNet	560-317
BM1000 EtherNet/IP	560-318
I/O module	
IO1000 module	560-310
Data cable 0.5 m	560-334
Data cable 5 m	560-335
Data cable 10 m	560-340
Sniffer line SL200	
SL200 sniffer line, 3.8 m long (an additional cable extension is required for connection to UL3000 Fab devices)	14005
Cable extension for the electrical connection of the SL200	551-205
SL200 sniffer line and cable extension for the electrical connection (set)	551-210
Sniffer line SL3000	
SL3000-3, sniffer line 3 m length	525-001
SL3000-5, sniffer line 5 m length	525-002
SL3000-10, sniffer line 10 m length	525-003
SL3000-15, sniffer line 15 m length	525-004
Holder for sniffer line SL3000	551-203
Sniffer line for system integration (robotic application)	525-015
Sniffer tip for the SL3000	
Sniffer tip ST312, 120 mm long, rigid	12213
Sniffer tip FT312, 120 mm long, flexible	12214
Sniffer tip ST200, 200 mm long, rigid	12218
Sniffer tip FT250, 250 mm long, flexible	12266
Sniffer tip ST385, 385 mm long, rigid	12215
Sniffer tip FT385, 385 mm long, flexible	12216
Sniffer tip FT600, 600 mm long, flexible	12209
Sniffer tip, rigid, 500 mm. 45° angled(ST 500)	12272

Further accessories for the SL3000	
Felt For Capillary Filter SL3xx, 50 pc.	200001116
Capillary filter, metal(1 unit)	12217
Capillary Filter SL 300, set 5 pieces(Plastic capillary filter)	20003501
Intern Filter For SL3XX (5/PKG)(Sinter-filter with O-Ring)	20003500
Water conservation tip (1 unit)	122 46
SL3000 bracket	551-203
Remote control RC1000	
Remote control RC1000WL, wireless	551-015
Remote control RC1000C, wired	551-010
Remote control extension cable	14022
Test chamber TC1000	
Test chamber TC1000	551-005
Cable extension for the electrical connection of the test chamber TC1000	551-205
Miscellaneous	
Helium bottle holder	551-201
Search gas spray gun, with hose	16555
SMART-Spray with 2 HeliCan Helium containers 50 ml, battery, charging cable, wrist strap, BT-Dongle, adapter cable for BT-Dongle	551-050

Sniffer line SL200

By using the sniffer line the leak detector can easily be converted to a sniffer leak searcher. The length of the sniffer line is 3.8 m.

To operate this sniffer line you also need a cable extension for the electrical connection.

For mounting the hooks for winding up the power line or sniffer line, see “Connect the supplied accessories [▶ 42]”.

Sniffer line SL3000

The sniffer line SL3000 is connected to the rear of the leak detector, so that a vacuum installation at the inlet flange on top of the leak detector does not have to be removed when changing to the operation mode "Sniffer". The sniffer line is available in 3, 5, 10 or 15 m lengths.

For mounting the hooks for winding up the power line or sniffer line, see “Connect the supplied accessories [▶ 42]”.

Helium bottle holder

The Helium bottle holder allows the transport of a Helium supply with a spray gun along with the leak detector. Only small to medium size bottles (max. 10 l, 200 bar) fit without compromising the stability of the device.

The installation instructions are supplied as a separate document with the bottle holder.

Remote control RC1000C and RC1000WL

With the RC1000C remote control you can operate the leak detector over a cable with a length of up to 28 m.

With the wireless remote control RC1000WL, you can operate the leak detector at a distance of up to 100 m.

Via remote control you control the functions START, STOP / VENT (STOP/Ventilate), ZERO (background). The measured leak rate is displayed as a bar graph, as a numeric value or as a diagram on the display of the remote controls (see the RC1000 Technical Manual).

Measurement values you create over a recording time of up to 24 hours in the internal memory of the RC1000. You transfer the data easily to a USB flash drive.

You can set an internal setpoint for warning when exceeding the setpoints. The warning occurs visually on the display and audibly via the built-in loudspeaker or the connected headset respectively.

The remote controls are placed in robust housings that allow ergonomic operation. Magnets on the lower side allow installation from horizontal to vertical metal surfaces.



Fig. 20: Remote control RC1000WL



Fig. 21: Fasten the transmitter with Velcro in a free place

Search for the wireless remote control from the leak detector

If you have misplaced the RC1000WL wireless remote control, you can trigger from your leak detector acoustic signals of this remote control.

- 1  > Setup > Accessories > RC1000
- 2 Select the setting "ON" in the field "Paging request".
⇒ The remote control emits acoustic signals.
- 3 To stop signals from being emitted after finding the remote control, select "OFF" in the "Paging request" field.

Test chamber TC1000



This test chamber converts the leak detector to a complete workstation, where hermetically sealed components can be tested. Also as per Standard MIL-STD 883 testing can be performed easily, quickly and accurately. The tests start automatically once the cover of the chamber is closed. Test parameters such as measurement time, rejection rate can be set in the "Auto Leak Test" menu. The test is performed automatically, the result is shown by red and green LEDs which are located on the test chamber. To operate this test chamber you also need a cable extension for the electrical connection.



10.2 I/O module



10.2.1 Create a connection between the device and the I/O module

✓  **Supervisor** rights

- 1 Connect the INFICON I/O module with a data cable to the LD socket on the rear of the device, see "Connections for accessories and control signals [▶ 31]".
- 2  > Setup > Accessories > Device selection
- 3 Select the "IO module".
- 4 Save .

10.2.2 Configuring analog outputs

✓  **Supervisor** rights

- 1  > Setup > Accessories > I/O module > Configuration of analog outputs
- 2 Set-up the "Analog output 1".
 - ⇒ You can choose from "Off", Pressure p1", Pressure p2", "Leak rate mantissa", "Leak rate exponent", "Leak rate linear", "Leak rate logarithmic", "Leak rate mantissa hyst.", and "Via interface".
- 3 Set-up the "Analog output 2".
 - ⇒ You can choose from "Off", Pressure p1", Pressure p2", "Leak rate mantissa", "Leak rate exponent", "Leak rate linear", "Leak rate logarithmic", "Leak rate mantissa hyst.", and "Via interface".
- 4 Set-up the "Analog output scaling".
 - ⇒ You can choose from "0.5 V / decade", "1 V / decade", "2 V / decade", "2.5 V / decade", "3 V / decade", "5 V / decade", or "10 V / decade".
- 5 Set-up the "Exponent upper limit".
- 6 Save .



The settings "Analog output scaling" and "Upper limit exponent" affect both analog outputs dependent on the selected function, see the table overview below.

Functions and assignment of analog outputs:

Off	The analog outputs are switched off (Output voltage = 0 V).	
-----	--	--

Pressure p1 / Pressure p2	1 ... 10 V; 0.5 V / decade; logarithmic 1 V = 1×10^{-3} mbar	
Leak rate mantissa	1 ... 10 V; linear; in the selected unit	Useful only if the other analog output is assigned "Leak rate exponent".
Leak rate exponent	1 ... 10 V; 0.5 V / decade; Step function; 1 V = 1×10^{-12} ; in selected unit	Useful only if the other analog output "Leak rate mantissa" or "Leak rate mantissa hyst." is assigned.
Linear leak rate	0 ... 10 V; linear; in the selected unit	<p>The upper limit (= 10 V) is set via the parameter "Exponent upper limit" in whole decades. The lower value is always 0 (leak rate), which corresponds to 0 V output voltage.</p> <p>This setting is for both analog outputs, if an appropriate output function is selected. Depending on the selected leak rate unit there is a different absolute limit.</p> <p>The selected range can be additionally narrowed by the limits, which is valid for all interfaces.</p>

Leak rate log.	0 ... 10 V; logarithmic; in the selected unit	The upper limit (= 10 V) and the scale (V / decades) are set via the parameters "Exponent upper limit" and "Analog output scaling". For example: Upper limit set to 1×10^{-5} mbar l/s (= 10 V). Scale set to 5 V / decade. The lower limit is thus 1×10^{-7} mbar l/s (= 0 V). The logarithmic output function of both the slope in V / decade as well as the upper limit (10 V limit) can be set. This results in the minimum displayable value. The following slopes are available: 0.5, 1, 2, 2.5, 3, 5, 10 V/decade. The higher the selected slope value, the smaller the displayable area. The upper limit is the same for both analog outputs. Depending on the selected leak rate unit there is a different absolute limit.
Set by interface	The output voltage can be specified for tests with the LD log command 221.	
Leak rate mantissa hyst.	0.7 ... 10 V; linear; in the selected unit	Useful only if the other analog output is assigned "Leak rate exponent". Through an overlap of the mantissa in the range 0.7 to 1.0, a constant jumping between two decades is prevented. 0.7 V corresponds to a leak rate of 0.7×10^{-x} . 9.9 V corresponds to a leak rate of 9.9×10^{-x} .

10.2.3 Configure digital inputs

These inputs can be used to operate the device with a programmable logic controller (PLC).

The digital inputs PLC-IN 1 ... The available functions can be assigned in any way necessary to the 10 I/O module.

- Active signal: typically 24 V
- Inactive signal: typically 0 V.

The 24V output of the I/O module can be used as an active signal.

Every function can be inverted.

✓  **Supervisor** rights

- 1  > Setup > Accessories > I/O module > Configuration of digital Inputs
- 2 Select as desired "Digital input".
 - ⇒ The inputs PLC-IN 1 - 10 are available.
- 3 Select the desired Function, see the table below.
- 4 Select the desired Mode.

⇒ The modes "Standard" or the mode "Inverse" are available for selection.
To mode "Inverse": In the following table overview, the arrow pointing the transfer direction in the column "Transition" must be reversed.

5 Save .

Function	Transition	Description
VENT	inactive→ active:	Vent inlet (only in standby state)
CAL	inactive→ active:	Start calibration.
	active→ inactive:	Apply value for background and finish calibration.
No function	-	The input is not functioning. Recommended setting of unused inputs.
Clear	inactive→ active:	Erase warning or error message / cancel calibration.
Sniff	inactive→ active:	Enable sniffer mode.
	active→ inactive:	Enable vacuum mode.
Purge	inactive→ active:	Switch-on purge (only in standby state)
	active→ inactive:	Switch-off purge (only in standby state)
Start	inactive→ active:	Change to the measurement mode.
Start/Stop	inactive→ active:	Change to the measurement mode.
	active→ inactive:	Switch to Standby.
Stop	inactive→ active:	Switch to Standby.
ZERO	inactive→ active:	Switch ZERO on.
	active→ inactive:	Switch ZERO off.

10.2.4 Configuring digital outputs

The digital outputs PLC-OUT 1 ... The available functions can be assigned in any way necessary to the 8 I/O module.

✓  **Supervisor** rights

1  > Setup > Accessories > I/O module > Configuration of digital outputs

2 Select the desired "Digital output".

⇒ The outputs PLC-OUT 1 - 8 are available.

3 Select the desired "Function", see the table below.

4 Select the desired "Mode".

⇒ The modes "Standard" or the mode "Inverse" are available for selection.

To mode "Inverse": In the table overview the description of the state "open" must be replaced with the description of the state "closed".

5 Save .

Function	State:	Description
Off (open)	open:	always open



Function	State:	Description
Ready for operation	closed:	Emission switched on, calibration process inactive, no error
	open:	Emission switched off or calibration process active or error
Emission on	closed:	Emission switched on
	open:	Emission switched off
Error	closed:	Error
	open:	No error
Error or warning	closed:	Error or warning
	open:	No error or warning
Run-up	closed:	Run up
	open:	no run-up
Calibration request	closed:	No external calibration: Calibration required When external calibration or "CAL check": Request "Open or close external calibrated leak"
	open:	No request: Calibration not required
Calibration active	closed:	Device is to be calibrated.
	open:	Device is not to be calibrated.
Calibration stable	closed:	Calibration completed with calibration leak
	open:	Assignment not stable or calibration is inactive
Cathode 2	closed:	Cathode 2 is active
	open:	Cathode 1 is active
Measuring	closed:	Measuring (ZERO is possible, all setpoint outputs switch depending on the leak rate.)
	open:	Standby or emission disabled (ZERO is not possible, all setpoint outputs will return "Leak rate threshold value exceeded".)
Open	open:	always open
Sniff	closed:	Operation mode Sniffing active
	open:	Operation mode Vacuum active
Setpoint 1	closed:	Measured leak rate exceeds the setpoint 1
	open:	Measured leak rate undercuts the setpoint 1
Setpoint 2	closed:	Measured leak rate exceeds the setpoint 2
	open:	Measured leak rate undercuts the setpoint 2
Setpoint 3	closed:	Measured leak rate exceeds the setpoint 3
	open:	Measured leak rate undercuts the setpoint 3

Function	State:	Description
Setpoint 4	closed:	Measured leak rate exceeds the setpoint 4
	open:	Measured leak rate undercuts the setpoint 4
Purge	closed:	Purge valve open
	open:	Purge valve closed
Vent	closed:	Internal vent valve open.
	open:	Internal vent valve closed
Standby or evacuate	closed:	State standby or evacuate active
	open:	State standby or evacuate not active, such as when measuring
Status calibration leak valve	closed:	Calibration leak valve is open
	open:	Calibration leak valve closed
Warning	closed:	Warning
	open:	No warning
ZERO active	closed:	ZERO switched on
	open:	ZERO switched off

10.2.5 Setting up the I/O module protocol

To switch between ASCII and LD protocol.

✓  **Supervisor** rights

- 1  > Setup > Accessories > I/O module > I/O module protocol
- 2 Adjust.
- 3 Save .

10.3 Bus module



On the USB stick enclosed with the device and the bus module BM1000 you will find further files on the subject of bus modules. This also includes the GSD file for PROFIBUS, which is located in the “..\Manuals\Interface Description“ folder.

For the different bus modules from INFICON see also “Accessories and spare parts [▶ 128]“.

10.3.1 Creating a connection between the device and the bus module

To establish the connection between the leak detector and the bus module, proceed as follows:



- 1 Switch off the leak detector.

- 2 Connect the INFICON bus module via a data cable to the LD socket of the device, see "Connections for accessories and control signals [▶ 31]".
- 3 Switch on the leak detector.
- 4  > Setup > Accessories > Device selection
- 5 Select the "Bus module" as device.
- 6 Confirm with .

10.3.2 Setting a bus module address



You can set the setpoint for the field bus address. With PROFIBUS® this is the node address. DeviceNet is the MAC ID.

This setting is irrelevant for Profinet and EtherNet/IP.

- 1  > Setup > Accessories > Bus module
- 2 Enter the desired address in the "Bus module address" field.
- 3 Confirm with .

⇒ The value set is first carried over when restarting the leak detector. To do this, switch the power supply off and back on.

10.4 Establish connection between device and SMART-Spray

- ✓  **Supervisor** rights
 - ✓ Software versions V1.42 (basic device) and V1.64 (device operation) or higher are installed on your leak detector.
 - ✓ You have a functional helium sprayer SMART-Spray.
 - ✓ You have a separate BT-Dongle (radio transmitter) and an adapter cable for the BT-Dongle.
- 1 Connect the BT-Dongle via the adapter cable to the REMOTE interface on the back of the leak detector, see "Connections for accessories and control signals [▶ 31]".
 - 2  > Setup > Accessories > Device selection
 - 3 Select "SMART-Spray" for the REMOTE connection.
 - 4 Save .

See also the separate operating instructions for the "SMART-Spray" helium sprayer.

10.5 Network

10.5.1 Operate leak detector via web browser (LAN)

NOTICE



Operating system can be attacked via USB or Ethernet

The Linux operating system used in the leak testing is not updated automatically and can therefore contain security gaps. This vulnerability may be exploited through the Ethernet and USB interfaces of the leak testing to provide unauthorized access to the system.

- ▶ Ensure that no unauthorized person has access to these interfaces, for example through a USB port / Ethernet port lock.
- ▶ In order not to jeopardize the security of your company network, never connect the leak testing directly to the public Internet. This is true for connections over WLAN as well as over Ethernet.
- ▶ However, if you want to access the web interface of the leak testing remotely, we recommend an encrypted Virtual Private Network (VPN) connection. However, we cannot assume any guarantee for the security of VPN connections, which are provided by third parties.

10.5.1.1 Configure the LAN connection of the leak detector

✓ Supervisor rights

- 1  > Setup > Network > LAN settings
 - ⇒ Alternatively press  in the menu bar.
- 2 In the "Method" field, select your LAN setting:
 - ⇒ Disabled: Even when the network cable (RJ45 socket) is connected, no network connection is established.
 - ⇒ DHCP: The leak detector automatically obtains an IP address through the network into which it is integrated.
 - ⇒ Static: The IP address, as well as the network mask and gateway have to be configured manually, so that the leak detector can be reached in the network. If necessary, contact a network administrator.
- 3 Save .

10.5.1.2 Setting the LAN connection in the PC or Tablet





LAN connection - quick start

If you have performed the steps described here once, it is sufficient to enter the IP address for many devices in case of repetition.

- ✓ The PC is connected to the same network as the leak detector.
- ✓ A LAN setting has been set up in the configuration of the leak detector, see also "Configure the LAN connection of the leak detector [▶ 139]".
- ✓ You have noted down the IP address of the leak detector. It can be found in the leak detector under "Diagnosis > Information > Device > Network".
- ✓ Java Script is enabled in the web browser. We recommend using a current version of the web browser Chrome™, Firefox® or Safari®.
- ▶ To access the leak tester from the PC or tablet web browser, enter the IP address of the leak detector as follows:
http://<IP address>
 - ⇒ The current active user interface of the leak detector is called.
 - ⇒ The same functionality is available on the PC or Tablet as on the touchscreen of the leak detector.

10.5.1.3 Allow client access

- ✓  **Supervisor** rights
 - 1  > Setup > Network > Client access
 - 2 To allow the leak detector to be operated by PC or Tablet, activate the "Client Access" option.
 - ⇒ If the option "Client Access" is not activated, the leak detector cannot be operated via PC or Tablet. No settings can then be changed.
 - 3 Save .



Display of all connected clients

- ✓ The network connection between the leak detector and one or more PCs or Tablets has been established, see "Setting the LAN connection in the PC or Tablet [▶ 140]".
- ▶  > Setup > Network > Connected clients

10.5.2 Operate leak detector via web browser (wireless LAN)

NOTICE

Operating system can be attacked via USB or Ethernet

The Linux operating system used in the leak testing is not updated automatically and can therefore contain security gaps. This vulnerability may be exploited through the Ethernet and USB interfaces of the leak testing to provide unauthorized access to the system.

- ▶ Ensure that no unauthorized person has access to these interfaces, for example through a USB port / Ethernet port lock.
- ▶ In order not to jeopardize the security of your company network, never connect the leak testing directly to the public Internet. This is true for connections over WLAN as well as over Ethernet.
- ▶ However, if you want to access the web interface of the leak testing remotely, we recommend an encrypted Virtual Private Network (VPN) connection. However, we cannot assume any guarantee for the security of VPN connections, which are provided by third parties.

In order to be able to access the user interface of the device via WiFi there needs to be a WiFi capable USB adapter with WiFi Access Point technology inserted in the rear of the control unit.

Minimum technical requirements:

- Interface: USB 2.0
- USB port: Type A
- Chipset: RTL819x or similar
- Support to: Access Point Client Mode

"EDIMAX EW-7612UAn V2" is a wireless LAN capable USB adapter, which meets the specification and has been tested with the leak detector.





The wireless LAN connection can be susceptible to interference. The stability depends on the range, shielding walls, other wireless networks, interfering transmitters in the vicinity and other factors.

10.5.2.1 Configure the wireless LAN connection of the leak detector

✓  **Supervisor** rights

1  > Setup > Network > WLAN settings

⇒ Alternatively press  in the menu bar.

- 2 To set-up that the device supports the WLAN connection activate the option "Enable Wireless LAN".
 - 3 In the field "WiFi Name (SSID)" enter the desired network name and in the field "WiFi Network key" the desired Network key.
 - ⇒ "WiFi Name (SSID)" and "WiFi Network key" have the following values preset: "UL Series" or "INFICONUL". The Network key must have at least 8 characters.
The network key is not displayed in plain text, all characters are replaced by dots. If you do not want this, then you have the option of changing the display mode via the symbol  behind the input field.
 - 4 Save .
- ⇒ If the wireless LAN capable USB adapter is inserted, this will automatically start the Access Point. In order to configure the WLAN adapter of the leak detector, no USB adapter needs to be inserted.

10.5.2.2 Setting the wireless LAN connection in the PC or Tablet



Wireless LAN connection - quick-start

If you have already performed these preset work steps, then on most devices it is sufficient just to enter the URL.

- ✓ A wireless LAN capable USB adapter with wireless LAN Access Point Technology is connected to a USB port of the leak detector, see "Control unit [▶ 23]".
 - ✓ In the configuration of the leak detector, the option "Enabled" is activated, see Configure the wireless LAN connection of the leak detector [▶ 141].
 - ✓ The WLAN connection is automatically detected by the client.
 - ✓ With old devices WPA2 may need to be set-up as the encoding.
 - ✓ Java Script is enabled in the web browser. We recommend using a current version of the web browser Chrome™, Firefox® or Safari®.
 - 1 Check the wireless settings of your PC or tablet to see if you are already connected to the wireless LAN of the leak detector.
 - 2 If it is not connected to the WLAN of the leak detector, select the WLAN of the leak detector and enter if necessary the Network key, see "Configure the wireless LAN connection of the leak detector [▶ 141]".
 - 3 To access the leak detector via the web browser of the PC or tablet, use the following URL:
ul.inficon.com
- ⇒ The current active user interface of the leak detector is called.
- ⇒ The same functionality is available on the PC or Tablet as on the touchscreen of the leak detector.

10.5.2.3 Allow client access

✓  **Supervisor rights**

1  > Setup > Network > Client access

2 To allow the leak detector to be operated by PC or Tablet, activate the "Client Access" option.

⇒ If the option "Client Access" is not activated, the leak detector cannot be operated via PC or Tablet. No settings can then be changed.

3 Save .



Display of all connected clients

✓ The network connection between the leak detector and one or more PCs or Tablets has been established, see "Setting the wireless LAN connection in the PC or Tablet [▶ 142]".

















▶  > Setup > Network > Connected clients

11 Appendix







11.1 Menu path





























Pressing the navigation button brings you back to the measurement display regardless of whether you were previously in a menu or sub-menu.





11.1.1 Diagnostics

- 1  > Confirmed warnings
⇒ Can only be seen when active.
- 2  > Errors and warnings
⇒ Can only be seen when active.
- 3  > Measurement data > Data recording
- 4  > Measurement data > Database information
- 5  > Measurement data > Measurement cycles
- 6  > Measurement data > Measurement data export
- 7  > Update > Update operating unit
- 8  > Update > Update operating unit > Operating unit expert update
- 9  > Update > Update Basic Unit
- 10  > Update > Update Basic Unit > Basic unit expert update
- 11  > Vacuum diagram
- 12  > Protocols > Result log
- 13  > Protocols > Maintenance log
- 14  > Protocols > Errors and warnings
- 15  > Protocols > Calibration log
- 16  > Regeneration





















11.1.2 Settings

- 1  > Display > General display settings
- 2  > Display > Bar chart
- 3  > Display > Circle chart
- 4  > Display > Line chart
- 5  > Display > Switch monitor
- 6  > Audio
- 7  > User accounts > Log off

- 8  > User accounts > Manage Automatic Login
- 9  > User accounts > Manage user accounts
- 10  > User accounts > Change own PIN
- 11  > User accounts > Change own language
- 12  > User accounts > Favorites
- 13  > Operation mode
- 14  > Setup > General > Notifications
- 15  > Setup > General > Date and time
- 16  > Setup > General > Settings of units
- 17  > Setup > General > Reset
- 18  > Setup > Data recording
- 19  > Setup > Measurement > Pressure limits
- 20  > Setup > Measurement > HYDRO•S
- 21  > Setup > Measurement > Mass
- 22  > Setup > Measurement > Calibration leak
- 23  > Setup > Measurement > Sniffing > Capillary surveillance
- 24  > Setup > Measurement > Sniffing > SL3000 sniffer line
- 25  > Setup > Measurement > Protection
- 26  > Setup > Measurement > Miscellaneous
- 27  > Setup > Measurement > Vacuum > Vacuum ranges
- 28  > Setup > Measurement > Vacuum > Auto Leak Test
- 29  > Setup > Measurement > Vacuum > Purge
- 30  > Setup > Measurement > Vacuum > Vent
- 31  > Setup > Measurement > ZERO and filter
- 32  > Setup > Network > Client access
- 33  > Setup > Network > LAN settings
- 34  > Setup > Network > Connected clients
- 35  > Setup > Network > WLAN settings
- 36  > Setup > Maintenance requests
- 37  > Setup > Maintenance counters
- 38  > Setup > Accessories > Bus module
- 39  > Setup > Accessories > Device selection
- 40  > Setup > Accessories > I/O module > I/O module protocol
- 41  > Setup > Accessories > I/O module > Configuration of analog outputs
- 42  > Setup > Accessories > I/O module > Configuration of digital outputs

- 43  > Setup > Accessories > I/O module > Configuration of digital Inputs
- 44  > Setup > Accessories > RC1000
- 45  > Parameter sets > Parameter list
- 46  > Parameter sets > Manage parameter sets
- 47  > Setpoints

11.1.3 Information

- 1  > Assemblies > Ion source
- 2  > Assemblies > TMP
- 3  > Assemblies > Backing pump
- 4  > Assemblies > Preamplifier
- 5  > Energy > Power
- 6  > Energy > Voltage (1)
- 7  > Energy > Voltage (2)
- 8  > Device > Operating hours
- 9  > Device > MSB
- 10  > Device > Network
- 11  > Device > Identification
- 12  > Help > Errors and warnings
- 13  > HYDRO•S
- 14  > Calibration
- 15  > Measurement values > Run times
- 16  > Measurement values > Leak rate and pressure
- 17  > Measurement values > Temperature
- 18  > Sniffer line
- 19  > Accessories > Bus module
- 20  > Accessories > I/O module

11.2 CE Declaration of Conformity



EU Declaration of Conformity

We – INFICON GmbH - herewith declare that the products defined below meet the basic requirements regarding safety and health and relevant provisions of the relevant EU Directives by design, type and the versions which are brought into circulation by us. This declaration of conformity is issued under the sole responsibility of INFICON GmbH.

In case of any products changes made without our approval, this declaration will be void

Designation of the product:

Helium Leak Detector

Models:

UL3000 Fab ULTRA

Catalogue number: **550-260**

Authorised person to compile the relevant technical files:

René Bausch, INFICON GmbH, Bonner Strasse 498, D-50968 Cologne

Cologne, June 09th, 2020

Dr. Döbler, President LDT

The products meet the requirements of the following Directives:

- **Directive 2006/42/EC (Machinery)**
- **Directive 2014/30/EU (EMC)**
- **Directive 2014/35/EU (Low Voltage)**
- **Directive 2011/65/EC (RoHS)**

Applied harmonized standards:

- **EN ISO 12100:2010**
- **EN 61326-1:2013**
Class A according to EN 55011
- **EN 61010-1:2010**
- **EN 50581:2012**

Cologne, June 09th, 2020

Sauerwald, Research and Development

INFICON GmbH
 Bonner Strasse 498
 D-50968 Cologne
 Tel.: +49 (0)221 56788-0
 Fax: +49 (0)221 56788-90
 www.inficon.com
 E-mail: leakdetection@inficon.com

11.3 Certificate (TÜV Rheinland)

Certificate



Certificate no.

WA 60157189 01

License Holder:
 INFICON GmbH
 Bonner Str. 498
 50968 Köln
 Deutschland

Manufacturing Plant:
 INFICON GmbH
 Bonner Str. 498
 50968 Köln
 Deutschland

Test report no.: USA-60411195 001

Client Reference: 41190346

Tested to: SEMI S2-0818Ea
 SEMI S8-0218

Certified Product:

License Fee - Units

Type designation: UL3000 Fab ULTRA

10

Rated voltage : AC 100-240V, 50/60Hz
 Rated power : 1500VA

10

Licensed Test mark:



TÜV Rheinland LGA Products GmbH



Date of Issue (day/mo/yr)

21/06/2021

TÜV Rheinland LGA Products GmbH, Tillystraße 2, 90431 Nürnberg, Tel. +49 221 806-1371, Fax +49 221 806-3935

11.4 RoHS

Restriction of Hazardous Substances (China RoHS)

有害物质限制条例（中国 RoHS）

UL3000 Fab ULTRA: Hazardous Substance UL3000 Fab ULTRA: 有害物质						
Part Name 部件名称	Lead (Pb) 铅	Mercury (Hg) 汞	Cadmium (Cd) 镉	Hexavalent Chromium (Cr(VI)) 六价铬	Polybrominated biphenyls (PBB) 多溴联苯	Polybrominated diphenyl ethers (PBDE) 多溴联苯醚
Assembled printed circuit boards 组装印刷电路板	X	O	O	O	O	O
Valve 阀门	X	O	O	O	O	O

This table is prepared in accordance with the provisions of SJ/T 11364.
本表是根据 SJ/T 11364 的规定编制的。

O: Indicates that said hazardous substance contained in all of the homogeneous materials for this part is below the limit requirement of GB/T 26572.
O: 表示该部件所有均质材料中所含的上述有害物质都在 GB/T 26572 的限制要求范围内。

X: Indicates that said hazardous substance contained in at least one of the homogeneous materials used for this part is above the limit requirement of GB/T 26572.
X: 表示该部件所使用的均质材料中，至少有一种材料所含的上述有害物质超出了 GB/T 26572 的限制要求。

(Enterprises may further provide in this box technical explanation for marking "X" based on their actual circumstances.)
(企业可以根据实际情况，针对含 "X" 标识的部件，在此栏中提供更多技术说明。)

Index

A			
Access controls	53	Display maximum leak rate	24
Activate additional function	92	Display runtimes	86
Auto Leak Test		Display temperature value	86
Operation mode (Definition)	20	E	
Result display	60	Evacuation time gross leak	63
Select operation mode	67	Evacuation time measurements	63
Settings	68	Exhaust	30, 46
Automated login		F	
Switch off	56	Factory Settings	34
Switch on	56	Function description	18
B			
Background signal	10	H	
Background suppression	9, 75, 76	HYDRO•S	
Bottle holder for helium bottles	130	Definition	18
Bus module	137	set	70
C		use	70
Calibrate		I	
External calibration	78	I/O module	132
Internal calibration	78	L	
with air helium	78	LAN	139
Calibrating		Allow client access	140, 143
Starting position	77	Configure leak detector	139
Calibration request	64	Settings PC or tablet	140
Change audio settings	61	M	
Change units	60	Machine factor	70
Changing the volume	61	Maintenance	115
Check calibration	79	Maintenance interval	
Check calibration leak	79	Air filter	63
Cleaning work	115	Sniffer tip filter	63
Connecting sniffer line SL200	19, 29	Maintenance plan	124
Connecting sniffer line SL3000	19	Maintenance requests	64
D		Measurement data	
Declaration of Contamination	126	Export format	83
Definition of terms	8	Export via network	84
Display background leak rate	59		
Display leak rate and pressure	86		

Modify Personal Settings	55	Setting the language	55
		SMART-Spray	129, 138
N		Sniffer line	
Notifications	66	Pressure monitoring	77
		Replacing the filter	118
O		Sniffer line SL200	129
Operating options	65	Sniffer line SL3000	129
Operation		Software	
PC, Tablet	142	Update basic unit	91
Operation mode "Sniffing"	18, 67	User interface update	90
Operation mode "Vacuum"	18, 67	Supervisor	54, 56
Operation mode Auto Leak Test	67	Switch monitor	92, 93
Operator	54	Switch off	95
O-Ring with filter	29	Switching on	52
P		T	
Proof	79	Take a screenshot	122
Pumping Argon		Technical Data	32
Pressure limits between vacuum ranges	71	Test chamber TC1000	131
Q		Touch monitor	24
Qmax	24	Touchscreen	27
		Icons	27
R		U	
RC1000 WL search (Paging)	131	User	53
Regeneration	74	User profile	
Release	92	create	54
Remote control RC1000	130	Delete	54
Remote control search (Paging)	131	edit	54
Restore factory settings	94	load	54
Return shipment	122, 123, 126	V	
Rights	53	Vacuum diagram	94, 144
S		Vacuum ranges	
Select gas	67	activate for measurement	68
Select operation mode	67	Change pressure limits	71
Select ventilation mode	74	FINE	71
Set external calibration leak	71	GROSS	71
Set of parameters		MASSIVE	71
Delete	89	ULTRA	71
load	89	Vent	73
Setting setpoints	67	W	

Web browser	141
WLAN	141
Allow client access	140, 143
Configure leak detector	141
Settings PC or tablet	142

Z

ZERO	81
Button	25
Factory setting	72
Zero point measurement	79



Due to our continuing program of product improvements, specifications are subject to change without notice.
The trademarks mentioned in this document are held by the companies that produce them.