

## Cold Cathode Gauge

Gemini MAG500, MAG504

Gemini MAG550, MAG554

## Cold Cathode Pirani Gauge

Gemini MPG500, MPG504

Gemini MPG550, MPG554







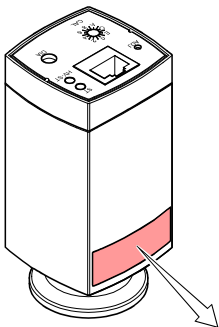

Operating Manual  
Incl. EU Declaration of Conformity

## Product Identification

In all communications with INFICON, please specify the information given on the product nameplate. For convenient reference copy that information into the space provided below.



INFICON AG, LI-9496 Balzers		  
Model:	_____	
PN:	_____	 
SN:	_____	
_____ VDC _____ W		 <small>3103457</small>

## Validity

This document applies to products of the MAG5xx and MPG5xx series:

### 3Mxx-xxx-xxxx

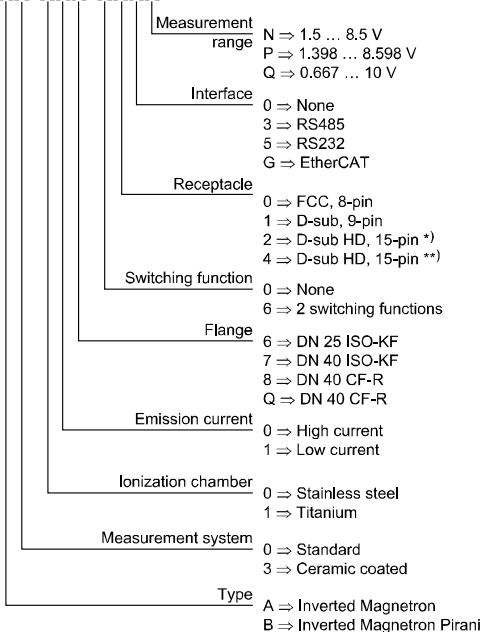

\*) EtherCAT

\*\*\*) RS232/485

The part number (PN) can be taken from the product nameplate.

If not indicated otherwise in the legends, the illustrations in this document correspond to a MxG50x gauge with FCC receptacle and vacuum connection DN 25 ISO-KF. They apply to the other products by analogy.

We reserve the right to make technical changes without prior notice.

## Intended Use

### **Gemini MAG500, MAG504, MAG550, MAG554**

The Cold Cathode Gauges Gemini MAG5xx have been designed for vacuum measurement of gases in the pressure range of  $1 \times 10^{-9}$  ...  $1 \times 10^{-2}$  mbar.

Gauges with gauge identification can be operated in connection with an INFICON Vacuum Gauge Controller of the VGC40x / VGC50x series.

### **Gemini MPG500, MPG504, MPG550, MPG554**

The Cold Cathode Gauges Gemini MPG5xx have been designed for vacuum measurement of gases in the pressure range of  $1 \times 10^{-9}$  ... 1000 mbar.

They must not be used for measuring flammable or combustible gases in mixtures containing oxidants (e.g. atmospheric oxygen) within the explosion range.

Gauges with gauge identification can be operated in connection with an INFICON Vacuum Gauge Controller of the VGC40x / VGC50x series.

## Functional Principle

### **Gemini MAG500, MAG504, MAG550, MAG554**

The gauge functions with a cold cathode ionization measurement circuit (according to the inverted magnetron principle).

Over the whole measurement range, the measuring signal is output as a logarithm of the pressure.

### **Gemini MPG500, MPG504, MPG550, MPG554**

The gauge consists of two separate measuring systems (the Pirani and the cold cathode system according to the inverted magnetron principle). They are combined in such a way that for the user, they behave like one measuring system.

Over the whole measurement range, the measuring signal is output as a logarithm of the pressure.



### **Scope of Delivery**

- 1x gauge
- 1x pin for adjusting settings via buttons (MPG gauges only)
- 1x Operating Manual German
- 1x Operating Manual English

## Contents

Product Identification	2
Validity	3
Intended Use	4
Functional Principle	4
Scope of Delivery	5
<b>1 Safety</b>	<b>8</b>
1.1 Symbols Used	8
1.2 Personnel Qualifications	8
1.3 General Safety Instructions	9
1.4 Liability and Warranty	9
<b>2 Technical Data</b>	<b>10</b>
2.1 Measuring Signal vs. Pressure	16
2.2 Gas Type Dependence MAG5xx	19
2.3 Gas Type Dependence MPG5xx	21
<b>3 Installation</b>	<b>24</b>
3.1 Vacuum Connection	24
3.2 Power Connection	28
3.2.1 FCC 68, 8-pin Connector	29
3.2.2 D-sub, 9-pin Connector	30
<b>4 Operation</b>	<b>31</b>
4.1 Status Indication MAG50x	31
4.2 Status Indication MPG50x	32
4.3 Put MAG5xx Into Operation	33
4.4 Put MPG5xx Into Operation	33
4.5 Gas Type Dependence	34
4.6 Ignition Delay	35
4.7 Contamination	35
<b>5 Deinstallation</b>	<b>37</b>
<b>6 Maintenance, Repair</b>	<b>39</b>
6.1 Adjusting the Gauge	39
6.2 Cleaning the Gauge / Replacing Parts	41
6.2.1 Troubleshooting (measuring chamber)	42
6.2.2 Replacing Ionization Chamber and Ignition Aid	44
6.2.3 Replacing Measuring Chamber	50
6.3 Troubleshooting	52

<b>7</b>	<b>Returning the Product</b>	<b>55</b>
<b>8</b>	<b>Disposal</b>	<b>56</b>
<b>9</b>	<b>Options</b>	<b>57</b>
<b>10</b>	<b>Accessories</b>	<b>57</b>
<b>11</b>	<b>Spare Parts</b>	<b>57</b>
11.1	Ignition aid for MAG5xx and MPG5xx	58
11.2	Ionization Chamber for MAG5xx and MPG5xx	58
11.3	Measuring Chamber Cpl. (Spare Sensor)	58
11.3.1	Measuring Chamber Cpl. for MAG5x0	58
11.3.2	Measuring Chamber Cpl. for MAG5x4	59
11.3.3	Measuring Chamber Cpl. for MPG5x0	59
11.3.4	Measuring Chamber Cpl. for MPG5x4	60
	<b>Literature</b>	<b>61</b>
	<b>ETL Certification</b>	<b>61</b>
	<b>EU Declaration of Conformity</b>	<b>62</b>

For cross-references within this document, the symbol (→  XY) is used, for cross-references to further documents, listed under literature, the symbol (→  [Z]).

# 1 Safety

## 1.1 Symbols Used



**DANGER**

Information on preventing any kind of physical injury.



**WARNING**

Information on preventing extensive equipment and environmental damage.



**Caution**

Information on correct handling or use. Disregard can lead to malfunctions or minor equipment damage.



Symbol printed on the product nameplate: Consultation of operating manual required



Notice



Labeling

## 1.2 Personnel Qualifications



**Skilled personnel**

All work described in this document may only be carried out by persons who have suitable technical training and the necessary experience or who have been instructed by the end-user of the product.



### 1.3 General Safety Instructions

- Adhere to the applicable regulations and take the necessary precautions for the process media used.  
Consider possible reactions with the product materials.  
Consider possible reactions (e.g. explosion) of the process media due to the heat generated by the product (MPG5xx only: Pirani filament 120 °C).
- Adhere to the applicable regulations and take the necessary precautions for all work you are going to do and consider the safety instructions in this document.
- Before beginning to work, find out whether any vacuum components are contaminated. Adhere to the relevant regulations and take the necessary precautions when handling contaminated parts.

Communicate the safety instructions to all other users.

### 1.4 Liability and Warranty

INFICON assumes no liability and the warranty becomes null and void if the end-user or third parties



- disregard the information in this document
- use the product in a non-conforming manner
- make any kind of interventions (modifications, alterations etc.) on the product
- use the product with accessories not listed in the product documentation.



The end-user assumes the responsibility in conjunction with the process media used.

Gauge failures due to contamination or wear and tear, as well as expendable parts (e.g. ionization chamber, ignition aid, Pirani filament (MPG5xx)), are not covered by the warranty.

## 2 Technical Data





For further technical data for gauges with RS232C or RS485C interface →  [1], with EtherCAT interface →  [2].

Measurement range (air, N <sub>2</sub> )	
MAG	1×10 <sup>-9</sup> ... 1×10 <sup>-2</sup> mbar
MPG	1×10 <sup>-9</sup> ... 1000 mbar
Accuracy MAG (N <sub>2</sub> )	
1×10 <sup>-8</sup> ... 1×10 <sup>-2</sup> mbar	30% of reading
Accuracy MPG (N <sub>2</sub> )	
1×10 <sup>-8</sup> ... 100 mbar	30% of reading
100 ... 1000 mbar	50% of reading
Repeatability (N <sub>2</sub> )	
MAG, 1×10 <sup>-8</sup> ... 1×10 <sup>-2</sup> mbar	5% of reading
MPG, 1×10 <sup>-8</sup> ... 100 mbar	5% of reading
Gas type dependence	
MAG	→  19
MPG	→  21
<hr/>	
Voltage range (analog output)	0 ... +10.5 V
Measurement range	
3MAX-xxx-xxxN	+1.5 ... +8.5 V (dc)
3MAX-xxx-xxxQ	+0.667 ... +10 V (dc)
3MBx-xxx-xxxP	+1.398 ... +8.6 V (dc)
Voltage vs. pressure	
3MAX-xxx-xxxN	1 V/decade, logarithmic
3MAX-xxx-xxxQ	1.33 V/decade, logarithmic
3MBx-xxx-xxxP	0.6 V/decade, logarithmic
Status signal	14.5 ... 30 V (ignited)
Error signal	
3MAX-xxx-xxxN	<+0.5 V
3MAX-xxx-xxxQ	≤+0.3 V
3MBx-xxx-xxxP	+9.5 ... +10.5 V

Output impedance	2 × 4.7 Ω, short-circuit proof
Load impedance	≥10 kΩ, short-circuit proof
Step response time	pressure dependent
>1×10 <sup>-6</sup> mbar	<100 ms
1×10 <sup>-6</sup> ... 1×10 <sup>-8</sup> mbar	≈1 s
<hr/>	
Gauge identification	
3MAx-xxx-000N <sup>1)</sup>	–
3MAx-xxx-000Q	100 kΩ referenced to supply common
3MBx-xxx-000P	85 kΩ referenced to supply common
<hr/>	
Status signal (digital output)	
FCC receptacle	
Current rating	100 mA
High voltage is ON	+14.5 ... +30 V (dc) (depending on supply voltage)
High voltage is OFF	0 V (dc)
D-sub receptacle	
Supply voltage	≤30 V (dc)
Current rating	100 mA (sink)
High voltage is ON	0 V (dc)
High voltage is OFF	open
<hr/>	
High voltage cut-in, low active (digital input)	
High voltage ON	<2.5 V (dc)
High voltage OFF	>4.0 V (dc)
High voltage cut-in, high active (digital input)	
High voltage ON	>11.0 V (dc)
High voltage OFF	< 5.0 V (dc)
<hr/>	

<sup>1)</sup> Not suited for operation with a VGC40x / VGC50x controller.

## Supply

		DANGER
	<p>The gauge may only be connected to power supplies, instruments, or control devices that conform to the requirements of a grounded protective extra-low voltage (PELV) and limited power source (LPS), Class 2. The connection to the gauge has to be fused. <sup>2)</sup></p>	

Supply voltage at the gauge <sup>3)</sup>	+14.5 ... +30 V (dc)
Ripple	≤1 V <sub>pp</sub>
Power consumption MxG50x	≤2 W
Fuse to be connected <sup>2)</sup>	≤1 AT

### High voltage in the measuring chamber

Ignition voltage	≤4.5 kV
Operating voltage	≤3.3 kV

### Current in the measuring chamber

3Mxx-x0x-xxxx	high current
3Mxx-x1x-xxxx	low current

### Electrical connection

3Mxx-xxx-00xx	FCC 68, 8-pin
3Mxx-xxx-01xx <sup>1)</sup>	D-sub, 9-pin

### Sensor cable

FCC connector	8-pin, shielded
D-sub connector	9-pin, shielded

Cable length (FCC only)	≤50 m (0.14 mm <sup>2</sup> /conductor)
-------------------------	---

<sup>2)</sup> INFICON controllers fulfill this requirement.

<sup>3)</sup> The minimum voltage of the power supply unit must be increased proportionally to the length of the sensor cable.

Grounding concept	→ "Power Connection"
Vacuum connection – signal common	connected via 10 kΩ (potential difference ≤16 V)
Supply common – signal common	conducted separately; differential measurement is recommended
<hr/>	
Materials exposed to vacuum	
Vacuum connection	stainless steel (1.4435)
Measuring chamber	stainless steel (1.4435)
Pirani filament (MPG5xx)	W
Feedthrough, MAG/MPG5x0	
Isolation	glass, ceramic (Al <sub>2</sub> O <sub>3</sub> )
Ring	stainless steel (1.4435)
Anode	molybdenum
Pin	Ni alloy
Feedthrough, MAG/MPG5x4	ceramic coated
Anode	molybdenum
Ionization chamber	
3Mxx-0xx-xxxx	stainless steel (1.4301, 1.4016)
3Mxx-1xx-xxxx	Ti
Ignition aid	stainless steel (1.4310)
Internal volume	
DN 25 ISO-KF	≈19.9 cm <sup>3</sup>
DN 40 ISO-KF	≈20.9 cm <sup>3</sup>
DN 40 CF-F	≈25.2 cm <sup>3</sup>
DN 40 CF-R	≈25.6 cm <sup>3</sup>
Permissible pressure (absolute)	10 bar, limited to inert gases <55 °C
Bursting pressure (absolute)	>13 bar

Permissible temperatures	
Operation	+5 °C ... +55 °C
Pirani filament (MPG)	120 °C
Bakeout	≤150 °C <sup>4)</sup>
Storage	-40 °C ... +70 °C
Relative humidity, year's mean during 30 days a year	
1×10 <sup>-8</sup> ... 1×10 <sup>-2</sup> mbar	≤70% (non-condensing)
1×10 <sup>-7</sup> ... 1×10 <sup>-2</sup> mbar	≤95% (non-condensing)
Mounting orientation	any
Use	indoors only, altitude up to 6000 m NN
Degree of protection	IP 40
<hr/>	
Weight	
Without fieldbus interface	
DN 25 ISO-KF	≤280 g
DN 40 ISO-KF	≤320 g
DN 40 CF-F und CF-R	≤570 g
With fieldbus interface	
DN 25 ISO-KF	≤500 g
DN 40 ISO-KF	≤530 g
DN 40 CF-F und CF-R	≤780 g
<hr/>	

---

<sup>4)</sup> Without electronics unit.

## Dimensions MxG50x [mm]

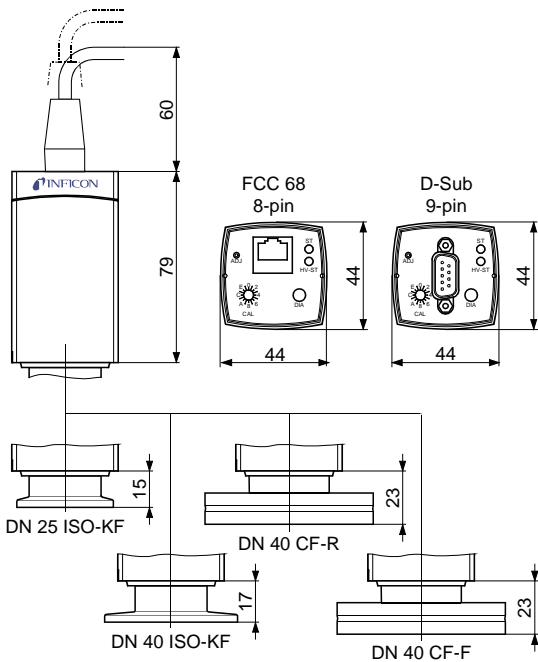

Dimensions MxG55x → [2].

## 2.1 Measuring Signal vs. Pressure

Measurement range 1.5 ... 8.5 V (3MAX-xxx-xxxN)

Pressure p

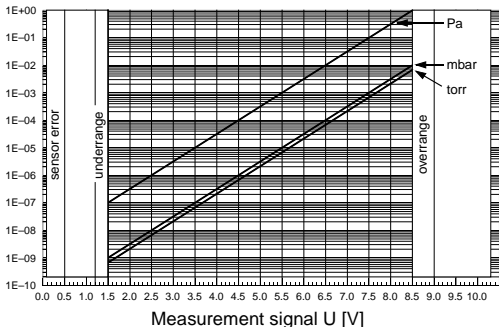

$$p = 10^{(U-c)} \quad \Leftrightarrow \quad U = c + \log_{10} p$$

valid in the range  $1 \times 10^{-9} \text{ mbar} < p < 1 \times 10^{-2} \text{ mbar}$   
 $7.5 \times 10^{-10} \text{ Torr} < p < 7.5 \times 10^{-3} \text{ Torr}$   
 $1 \times 10^{-7} \text{ Pa} < p < 1 \text{ Pa}$

	mbar	Pa	Torr
c	10.5	8.5	10.625

where p pressure  
 U measurement signal  
 c constant (pressure unit dependent)



## Measurement range 0.667 ... 10 V (3MAx-xxx-xxxQ)

Pressure p

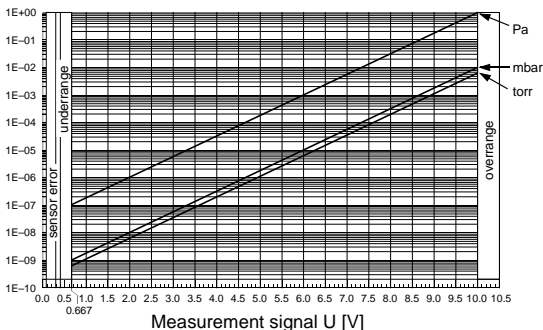

$$p = 10^{(U-c)/1.33}$$

↔

$$U = c + 1.33 \log p$$

valid in the range  $1 \times 10^{-9}$  mbar  $< p < 1 \times 10^{-2}$  mbar  
 $7.5 \times 10^{-10}$  Torr  $< p < 7.5 \times 10^{-3}$  Torr  
 $1 \times 10^{-7}$  Pa  $< p < 1$  Pa

	mbar	Pa	Torr
c	12.66	10	12.826

where p pressure  
 U measurement signal  
 c constant (pressure unit dependent)

## Measurement range 1.398 ... 8.6 V (3MBx-xxx-xxxP)

Pressure p

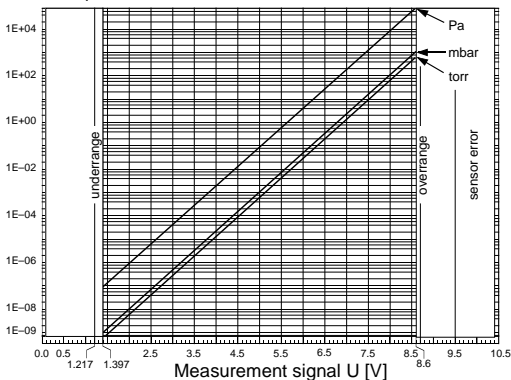

$$p = 10^{1.667U-d} \quad \Leftrightarrow \quad U = c + 0.6 \log p$$

valid in the range  $1 \times 10^{-9}$  mbar < p < 1000 mbar  
 $7.5 \times 10^{-10}$  Torr < p < 750 Torr  
 $1 \times 10^{-7}$  Pa < p <  $1 \times 10^5$  Pa

	mbar	Pa	Torr
c	6.798	5.598	6.873
d	11.33	9.333	11.46

where p pressure  
 U measurement signal  
 c, d constant (pressure unit dependent)

## 2.2 Gas Type Dependence MAG5xx

Indicated pressure (gauge calibrated for air)

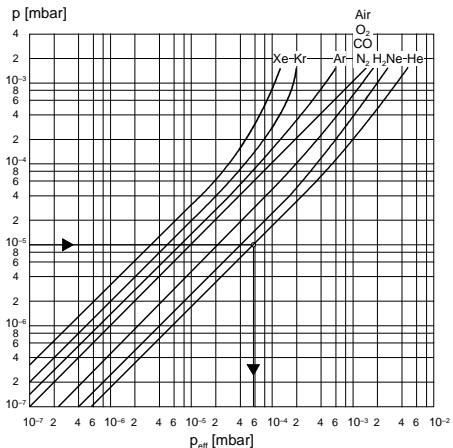

### Indication range below $10^{-5}$ mbar

In the range below  $10^{-5}$  the pressure indication is linear. For gases other than air, the pressure can be determined by means of a simple conversion formula:

$$p_{\text{eff}} = K \times \text{indicated pressure}$$

where:	Gas type	K
	Air (N <sub>2</sub> , O <sub>2</sub> , CO)	1.0
	Xe	0.4
	Kr	0.5
	Ar	0.8
	H <sub>2</sub>	2.4
	Ne	4.1
	He	5.9

These conversion factors are average values.



A mixture of gases and vapors is often involved. In this case, accurate determination is only possible with a partial pressure measurement instrument, e.g. a quadrupole mass spectrometer.

## 2.3 Gas Type Dependence MPG5xx

Indication range from  $10^2$  ...  $10^{-2}$  mbar  
(Pirani-only operation)

Indicated pressure (gauge calibrated for air)

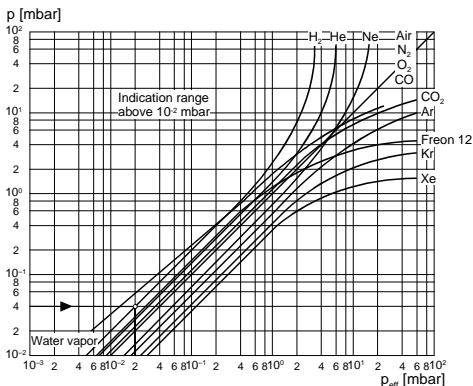

## Indication range $10^{-6}$ ... 0.1 mbar

Indicated pressure (gauge calibrated for air)

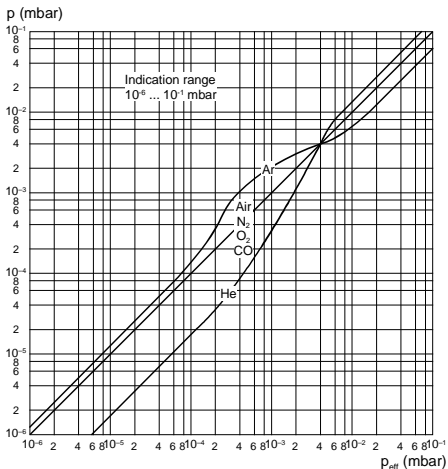

## Indication range below $10^{-5}$ mbar

In the range below  $10^{-5}$  the pressure indication is linear. For gases other than air, the pressure can be determined by means of a simple conversion formula:

$$p_{\text{eff}} = K \times \text{indicated pressure}$$

where:	Gas type	K
	Air (N <sub>2</sub> , O <sub>2</sub> , CO)	1.0
	Xe	0.4
	Kr	0.5
	Ar	0.8
	H <sub>2</sub>	2.4
	Ne	4.1
	He	5.9

These conversion factors are average values.



A mixture of gases and vapors is often involved. In this case, accurate determination is only possible with a partial pressure measurement instrument, e.g. a quadrupole mass spectrometer.

## 3 Installation

### 3.1 Vacuum Connection



**DANGER**

Overpressure in the vacuum system >1 bar  
Injury caused by released parts and harm caused by escaping process gases can result if clamps are opened while the vacuum system is pressurized.  
Do not open any clamps while the vacuum system is pressurized. Use the type clamps which are suited to overpressure.



**DANGER**

Overpressure in the vacuum system >2.5 bar  
KF flange connections with elastomer seals (e.g. O-rings) cannot withstand such pressures. Process media can thus leak and possibly damage your health.  
Use O-rings provided with an outer centering ring.





## DANGER



### Protective ground

Products that are not correctly connected to ground can be extremely hazardous in the event of a fault.

Electrically connect the gauge to the grounded vacuum chamber. This connection must conform to the requirements of a protective connection according to EN 61010:

- CF connections fulfill this requirement
- For gauges with a KF flange, use a conductive metallic clamping ring.



## Caution



### Vacuum component

Dirt and damages impair the function of the vacuum component.

When handling vacuum components, take appropriate measures to ensure cleanliness and prevent damages.



## Caution



### Dirt sensitive area

Touching the product or parts thereof with bare hands increases the desorption rate.

Always wear clean, lint-free gloves and use clean tools when working in this area.

Mount the gauge so that no vibrations occur. Vibrations at the gauge cause a deviation of the measured values.

The gauge may be mounted in any orientation. To keep condensates and particles from getting into the measuring chamber preferably choose a horizontal to upright position.

For potentially contaminating applications and to protect the measurement system against contamination, installation of the optional seal with centering ring and filter is recommended (Options → 57).

Remove the protective lid and connect the product to the vacuum system.

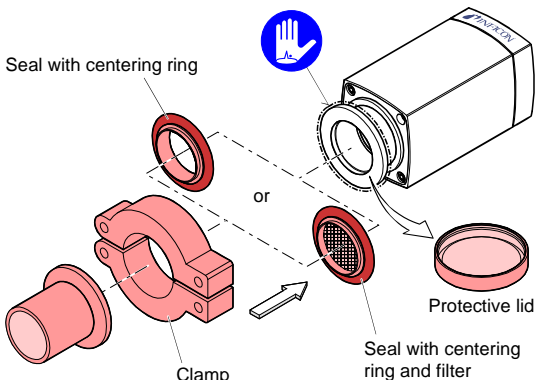

Keep the protective lid.

 When making a CF flange connection, it may be advantageous to temporarily remove the electronics unit.

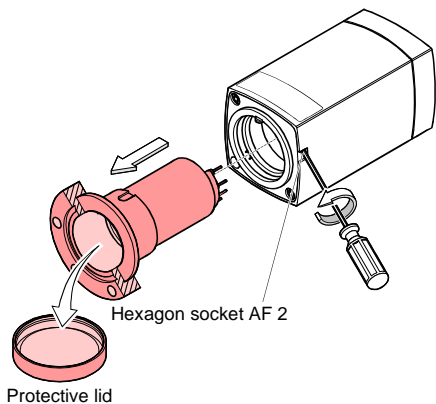



Keep the protective lid.

## 3.2 Power Connection



Make sure the vacuum connection is properly made (→  24).

**DANGER**



The gauge may only be connected to power supplies, instruments or control devices that conform to the requirements of a grounded protective extra-low voltage (PELV) and limited power source (LPS), Class 2. The connection to the gauge has to be fused.<sup>5)</sup>



Ground loops, differences of potential, or EMC problems may affect the measurement signal. For optimum signal quality, please do observe the following notes:

- Use an overall metal braided shielded cable. The connector must have a metal case.
- Connect the supply common with protective ground directly at the power.
- Use differential measurement input (signal common and supply common conducted separately).
- Potential difference between supply common and housing  $\leq 6$  V (overvoltage protection).

---

<sup>5)</sup> INFICON controllers fulfill these requirements.

### 3.2.1 FCC 68, 8-pin Connector

If no sensor cable is available, make one according to the following diagram. Connect the sensor cable.

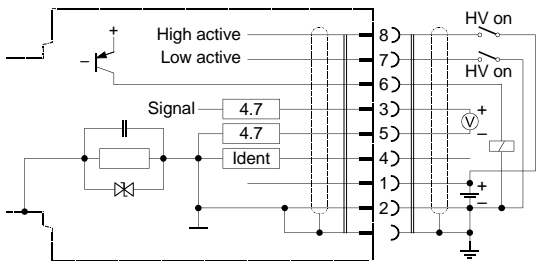

#### Electrical connection

- Pin 1 Supply (14.5 ... 30 V (dc))
- Pin 2 Supply common GND
- Pin 3 Signal output (measuring signal)
- Pin 4 Gauge identification
- Pin 5 Signal common
- Pin 6 Status signal
- Pin 7<sup>1)</sup> High voltage on/off (low active)
- Pin 8<sup>1)</sup> High voltage on/off (high active)

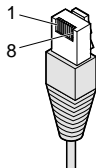

FCC 68  
8-pin

<sup>1)</sup> MAG only. Pin 7 and 8 are not assigned in the MPG gauge.

### 3.2.2 D-sub, 9-pin Connector

If no sensor cable is available, make one according to the following diagram. Connect the sensor cable.

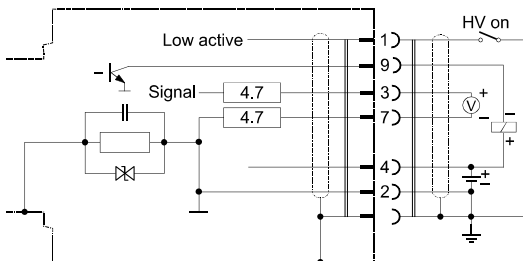

#### Electrical connection

- Pin 1<sup>\*)</sup> High voltage on/off (low active)
- Pin 2 Supply common GND
- Pin 3 Signal output (measuring signal)
- Pin 4 Supply (14.5 ... 30 V (dc))
- Pin 5 not assigned
- Pin 6 do not connect
- Pin 7 Signal common
- Pin 8 not assigned
- Pin 9 Status signal

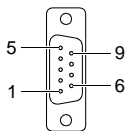

D-sub  
9-pin  
female  
soldering side

<sup>\*)</sup> MAG only. Pin 1 is not assigned in the MPG gauge.

## 4 Operation

### 4.1 Status Indication MAG50x

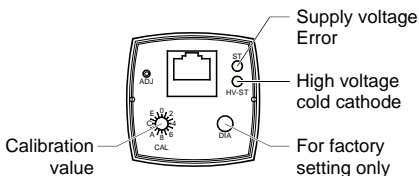

LED		Meaning
<ST>	<HV-ST>	
off	off	No supply voltage
lit solid green	off	Supply voltage = ok, no high voltage in the measuring chamber
lit solid green	blinking green	Supply voltage = ok, pressure in the cold cathode range, cold cathode has not ignited
lit solid green	lit solid green	Cold cathode has ignited
blinking red	off	EEPROM error

Troubleshooting →  53.

Status indication MAG55x →  [2].

## 4.2 Status Indication MPG50x

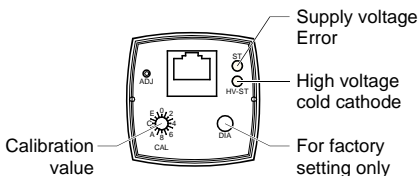



LED		Meaning
<ST>	<HV-ST>	
off	off	No supply voltage
lit solid green	off	Supply voltage = ok, Pirani active, no high voltage in the measuring chamber
lit solid green	blinking green	Supply voltage = ok, pressure in the cold cathode range, cold cathode has not ignited
lit solid green	lit solid green	Cold cathode has ignited.
lit solid red	off	Measurement system error
blinking red	off	EEPROM error

Troubleshooting →  54.

Status indication MPG55x →  [2].



### 4.3 Put MAG5xx Into Operation

	 <b>Caution</b>
	<p>Turn on the gauge/high voltage only at pressures <math>&lt;10^{-2}</math> mbar to prevent excessive contamination.</p> <p>If you are using an INFICON measurement unit for Compact Gauges with at least two gauge connections, the cold cathode gauge can be controlled, for example, by a Pirani gauge.</p>

#### MAG50x with FCC connector

When the supply voltage is applied and the high voltage is switched on via pin 7 (low active) or pin 8 (high active), the measuring signal is available at the signal output.

#### MAG5xx with D-sub connector

When the supply voltage is applied and the high voltage is switched on via pin 1 (D-sub 9-pin, low active), or via pin 8 (D-sub HD 15-pin, low active), the measuring signal is available at the signal output.

### 4.4 Put MPG5xx Into Operation

When the supply voltage is applied, the measuring signal is available at the signal output (→  29).

Allow for a stabilizing time of approx. 10 min. Once the gauge has been switched on, it can remain in operation permanently irrespective of the pressure.

## Measurement Principle, Measuring Behavior

The gauge consists of two separate measuring systems (Pirani and cold cathode system according to the inverted magnetron principle). They are combined in such a way that for the user, they behave like one measuring system.

The optimum measuring configuration for the particular pressure range, in which measurement is performed, is used:

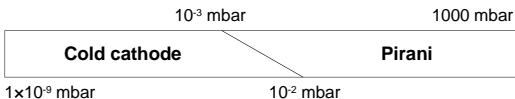



- The Pirani measuring circuit is always on
- The cold cathode measuring circuit is controlled by the Pirani circuit and is activated only at pressures  $p < 1 \times 10^{-2}$  mbar

As long as the cold cathode measuring circuit has not ignited, the measuring value of the Pirani is output as measuring signal.

## 4.5 Gas Type Dependence

The measurement value is gas dependent. The pressure reading applies to dry air, O<sub>2</sub>, CO and N<sub>2</sub>. For other gases, it has to be corrected:

- (MAG5xx →  19)
- (MPG5xx →  21).

If the gauge is operated with an INFICON controller, a calibration factor for correction of the actual reading can be applied (→  of the corresponding controller).

## 4.6 Ignition Delay

An ignition delay occurs when cold cathode gauges are switched on. The delay time increases at low pressures and for clean, degassed gauges it is typically:

$1 \times 10^{-5}$ ... $1 \times 10^{-2}$ mbar	< 1	second
$1 \times 10^{-7}$ ... $1 \times 10^{-5}$ mbar	< 20	seconds
$5 \times 10^{-9}$ ... $1 \times 10^{-7}$ mbar	< 2	minutes
< $5 \times 10^{-9}$ mbar	< 20	minutes

The ignition is a statistical process. Already a small amount of depositions on the inner surfaces can have a strong influence on it.

### MPG5xx only

As long as the cold cathode measuring circuit has not ignited, the measuring value of the Pirani is output as measuring signal. The status output (= 0 V) indicates the Pirani-only operation.



If the high voltage is activated at a pressure  $p < 3 \times 10^{-9}$ , the gauge cannot recognize whether the cold cathode system has ignited.



Once flanged on, permanently leave the gauge in the operating mode irrespective of the pressure range. Like this, the ignition delay of the cold cathode measuring circuit is always negligible (<1 s), and thermal stabilizing effects are minimized.

## 4.7 Contamination

Gauge failures due to contamination or wear and tear, as well as expendable parts (e.g. ionization chamber, ignition aid, Pirani filament (MPG5xx)), are not covered by the warranty.

Gauge contamination is influenced by the process media used as well as any existing or new contaminants and their respective partial pressures. Continuous operation in the range of  $10^{-4}$  mbar ...  $10^{-2}$  mbar can cause severe contamination as well as reduced up-time.

Contamination of the gauge generally causes a deviation of the measured values:

- MPG5xx only: In the high pressure range ( $1 \times 10^{-3}$  mbar ... 0.1 mbar), the pressure reading is too high (contamination of the Pirani element). Readjustment of the Pirani →  39.
- In the low pressure range ( $p < 1 \times 10^{-3}$  mbar), the pressure indication is usually too low (as a consequence of the contamination of the cold cathode system). In case of severe contamination, instabilities can occur (layers of the measuring chamber peel off). Contamination due to isolating layers can even lead to a complete failure of the discharge.

Contamination can to a certain extent be reduced by:

- geometric protection (e.g. screenings, elbows) against particles that spread rectilinearly
- mounting the flange of the gauge at a place where the partial pressure of the pollutants is particularly low.

Special precautions are required for vapors deposited under plasma (of the cold cathode measuring system). While vapors occur it may even be necessary

- to temporarily switch of the gauge
- to temporarily seal off of the gauge from the vacuum chamber using a valve.

## 5 Deinstallation



### DANGER



Contaminated parts

Contaminated parts can be detrimental to health and environment.

Before beginning to work, find out whether any parts are contaminated. Adhere to the relevant regulations and take the necessary precautions when handling contaminated parts.



### Caution



Vacuum component

Dirt and damages impair the function of the vacuum component.

When handling vacuum components, take appropriate measures to ensure cleanliness and prevent damages.



### Caution



Dirt sensitive area

Touching the product or parts thereof with bare hands increases the desorption rate.

Always wear clean, lint-free gloves and use clean tools when working in this area.

- 1 Vent the vacuum system.
- 2 Put the gauge out of operation and disconnect the sensor cable.

- 3** Remove gauge from the vacuum system and install the protective lid.



When deinstalling the CF flange connection, it may be advantageous to temporarily remove the electronics unit (→ 27).

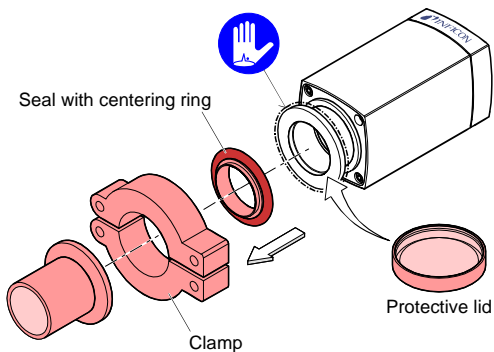

## 6 Maintenance, Repair



Gauge failures due to contamination and wear and tear, as well as expendable parts (e.g. ionization chamber, ignition aid, Pirani filament (MPG5xx)), are not covered by the warranty.

INFICON assumes no liability and the warranty becomes null and void if any repair work is carried out by the end-user or third parties.

### 6.1 Adjusting the Gauge

#### MAG5xx

The gauge is factory-calibrated and requires no maintenance. In the event of a defect

- only replace the ionization chamber and ignition aid, or
- replace the measuring chamber cpl. (spare sensor).

#### MPG5xx



The cold cathode measuring circuit, which is dominant for low pressures ( $<1 \times 10^{-3}$  mbar), is factory-calibrated and cannot be adjusted. The HV adjustment of the Pirani measuring circuit is carried out automatically by the gauge itself at pressures  $<1 \times 10^{-5}$  mbar. The new zero point is saved non-volatile every 15 minutes. Any adjustment has a negligible effect on the pressure range between approx.  $10^{-2}$  mbar and  $10^2$  mbar.

If used under different climatic conditions, through extreme temperatures, aging or contamination the characteristic curve can be offset and a manually readjustment or a maintenance may become necessary.

An adjustment via the <ADJ> button can become necessary (procedure → ④, ⑤), if pressure values  $<10^{-2}$  mbar are no longer output.

For adjusting the zero, operate the gauge under the same constant ambient conditions and in the same mounting orientation as normally.

The zero can be adjusted via

- the <ADJ> button on the gauge,
- the diagnostic port (→  [1]),
- the RS232C/485C interface (→  [1]),
- the EtherCAT interface (→  [2]).

- 1** If you are using a seal with centering ring and filter, check that they are clean or replace them if necessary (→ "Deinstallation").
- 2** Put the gauge into operation and operate it at atmospheric pressure for at least 10 minutes.
- 3** Briefly press the <ADJ> button with a pin (max.  $\varnothing 1.1$  mm) and the ATM adjustment is carried out, or ...

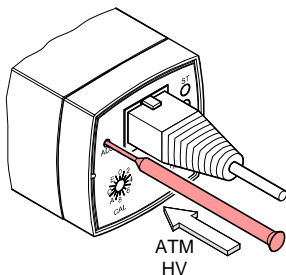

... perform the adjustment via the diagnostic port or via the EtherCAT interface.

The Pirani sensor is adjusted to 1000 mbar (duration  $\approx 5$  s).



- ✓ If the pressure value 1000 mbar is output at the measurement value output, the adjustment has been successful. Otherwise, repeat the adjustment procedure.

**4** Evacuate the vacuum system to  $p < 10^{-5}$  mbar and wait at least 2 minutes.

**5** Press the <ADJ> button with a pin and the HV adjustment is carried out (duration  $\approx 5$  s).

- ✓ If the pressure value  $1 \times 10^{-5}$  mbar is output at the measurement value output, the adjustment has been successful. Otherwise, repeat the adjustment procedure.

## 6.2 Cleaning the Gauge / Replacing Parts



In case of severe contamination or defective (e.g. pirani filament rupture (MPG5xx)), replace the complete measuring chamber (Spare Parts →  57).

 **DANGER**



Contaminated parts

Contaminated parts can be detrimental to health and environment.

Before beginning to work, find out whether any parts are contaminated. Adhere to the relevant regulations and take the necessary precautions when handling contaminated parts.



### Caution



Vacuum component

Dirt and damages impair the function of the vacuum component.

When handling vacuum components, take appropriate measures to ensure cleanliness and prevent damages.



### Caution



Dirt sensitive area

Touching the product or parts thereof with bare hands increases the desorption rate.

Always wear clean, lint-free gloves and use clean tools when working in this area.



### DANGER



Cleaning agents

Cleaning agents can be detrimental to health and environment.

Adhere to the relevant regulations and take the necessary precautions when handling and disposing of cleaning agents. Consider possible reactions with the product materials (→  13).

## Precondition

Gauge deinstalled.

## 6.2.1 Troubleshooting (measuring chamber)

If the cause of the fault is suspected to be in the measuring chamber, the following checks can be made with an ohmmeter.

## Tools / material required

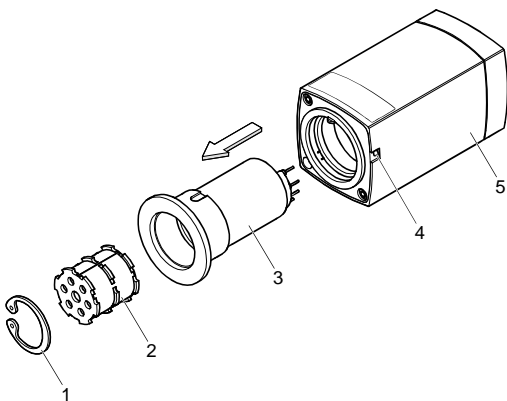

- Allen wrench AF 2
- Pliers for retaining ring
- Ohmmeter





- 1** Unfasten the hexagon socket set screw (4) and remove the complete measuring chamber (3) from the electronics unit (5).
- 2** Remove the retaining ring (1) as well as the ionization chamber (2) from the measuring chamber (3).
- 3** Check the ionization chamber and the measuring chamber for contamination:

  - Ionization chamber is contaminated only: Replace ionization chamber (→ [44](#))
  - Measuring chamber is severely contaminated: Replace complete measuring chamber (→ [50](#)).

- 4** Using an ohmmeter, make following measurements on the contact pins.

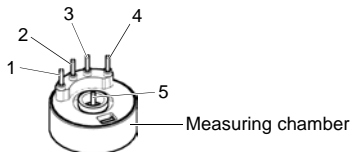
Measurement between pins			Possible cause
1 + 4	39.5 ... 40.5 $\Omega$ (at 20 °C)	Values outside of the range	Pirani filament rupture
1 + 2	1000 ... 1100 $\Omega$ (at 20 °C)	Values outside of the range	Pirani temperature sensor rupture
5 + measuring chamber	$\infty$	$\ll \infty$	Contamination, short circuit cold cathode





All of these faults can only be remedied by replacing the complete measuring chamber (→  50).

- 5** We recommend to perform a leak test (leak rate  $<1 \times 10^{-9}$  mbar l/s).

## 6.2.2 Replacing Ionization Chamber and Ignition Aid

### Precondition

Troubleshooting (measuring chamber) performed (→  42).

- 1** Due to contamination remove the ignition aid with the removing tool (Accessories →  57).

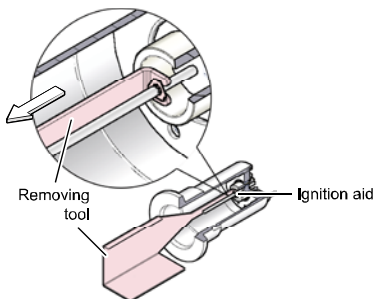

- 2** Insert e.g. a Scotch-Brite into the mounting tool ...

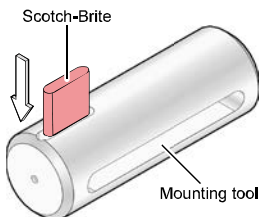

... and carefully rub the anode to a bright finish.

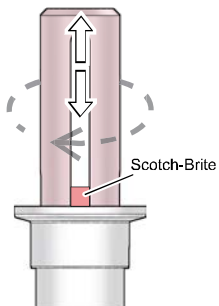

Do not bend the anode.

- 3** Insert e.g. a Scotch-Brite into the mounting tool ...

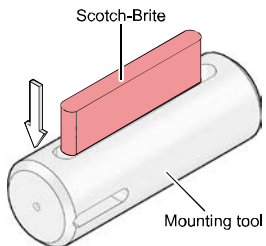

... and carefully rub the measuring chamber to a bright finish.

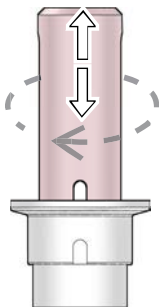

Do not bend the anode.

- 4** We recommend to rub the inside walls of the measuring chamber up to the groove for the retaining ring to a bright finish using a polishing cloth.



- The sealing surfaces must only be worked concentrically.
- Do not bend the anode.

- 5** Rinse the measuring chamber with alcohol and allow it to dry.

- 6** Insert the new ignition aid into the mounting tool with the flat side upwards ...

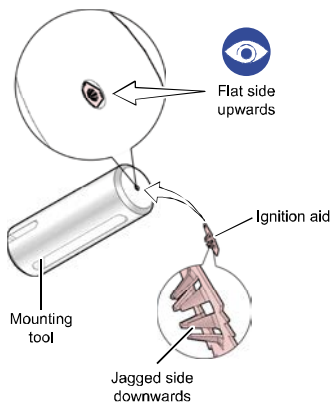

... and carefully slide it onto the anode until the stop position is reached.

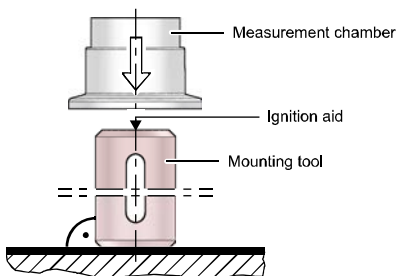



- 7 Remove particles in the measuring chamber by blowing with dry nitrogen (while the vacuum flange of the measuring chamber is pointing downward).
- 8 Slide a new ionization chamber (2) into the measuring chamber (3) until the mechanical stop is reached and mount the retaining ring (1) (Spare Parts → 57).

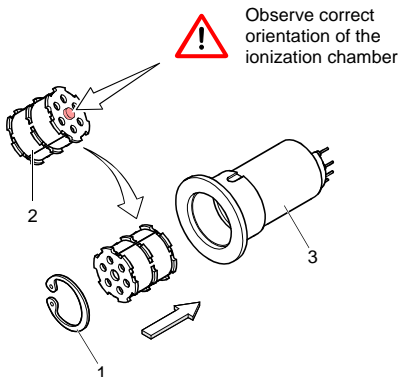

- 9 We recommend to perform a leak test (leak rate  $<1 \times 10^{-9}$  mbar l/s).
- 10 Carefully slide the measuring chamber cpl. (3) (clean or new) into the electronics unit (5) until the mechanical stop is reached ...



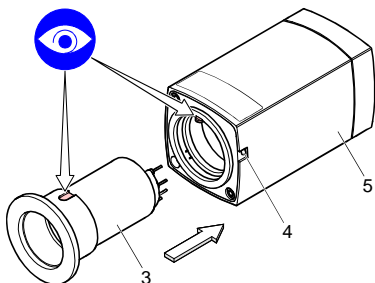

... and fasten it by means of the hexagon socket set screw (4).

### 6.2.3 Replacing Measuring Chamber

#### Precondition

Troubleshooting (measuring chamber) performed (→ 42).

- 1 Set the calibration value of the spare sensor with the <CAL> switch on the electronics unit (5).

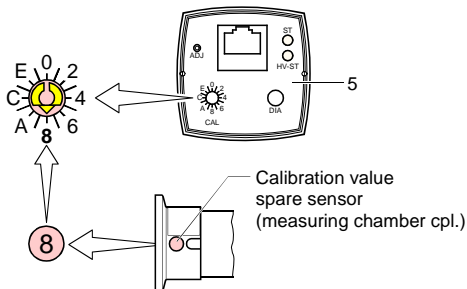

- 2** Carefully slide the measuring chamber cpl. (3) into the electronics unit (5) until the mechanical stop is reached.



Pins aligned straight.

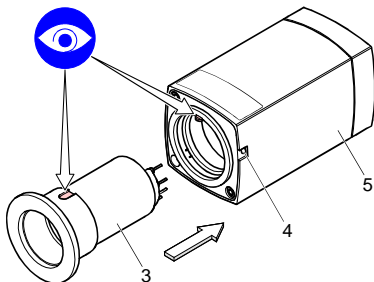
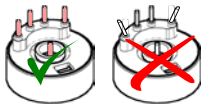

- 3** Fasten the measuring chamber (3) by means of the hexagon socket set screw (4).
- 4** MPG5xx gauge only: Perform an ATM and HV adjustment of the Pirani measuring circuit via the <ADJ> button (→ 40).



A recalibration of the MAG5xx gauge is not necessary.

## 6.3 Troubleshooting



In case of an error, it may be helpful to just turn off the mains supply and turn it on again after 5 s.

Problem	LED <ST>	LED <HV-ST>	Status signal	Possible cause	Correction
No voltage at signal output.	off	off	0	No supply voltage.	Turn on power supply.
Measuring signal unstable.	lid solid green	lid solid green	0	Gauge contaminated.	Replace ionization chamber or measuring chamber cpl. (→ 44, 50).
Voltage at signal output 0.15 V	lid solid green	off	0	No high voltage in the measuring chamber.	Switch on the high voltage (→ 29).
Voltage at signal output 1.2 V (3MAX-xxx-xxxN) 0.4 V (3MAX-xxx-xxxQ).	lid solid green	blinking green	0	Overpressure in the measuring chamber. Gas discharge has not ignited.	Evacuate the vacuum system to $<10^{-2}$ mbar and switch the gauge off and on again via "HV ON". Wait, until the gas discharge has ignited ( $\approx 5$ minutes at a pressure of $10^{-9}$ mbar).
Voltage at signal output continually $< 0.3$ V (3MAX-xxx-xxxN) $< 0.5$ V (3MAX-xxx-xxxQ).	blinking red	off	0	EEPROM error.	Switch the gauge off and on again after 5 s. Replace the gauge.
Signal continually at approx. $5 \times 10^{-4}$ mbar.	lid solid green	lid solid green	14.5 ... 30 V	Measuring chamber severely contaminated.	Replace the measuring chamber cpl. (→ 50).

Problem	LED <ST>	LED <HV-ST>	Status signal	Possible cause	Correction
No voltage at signal output.	off	off	0	No supply voltage.	Turn on power supply.
Measuring signal unstable.	lid solid green	lid solid green	0	Gauge contaminated.	Replace ionization chamber or measuring chamber cpl. (→ 44, 50).
Voltage at signal output does not drop under <4.82 V.	lid solid green	blinking green	0	Gas discharge has not ignited.	Wait, until the gas discharge has ignited (≈5 minutes at a pressure of $10^{-9}$ mbar).
Voltage at signal output continually > 5.6 V.	lid solid green	off	0	Pirani zero point shift.	Perform a HV adjustment via button (→ 41).
Voltage at signal output continually > 9.5 V.	lid solid red	off	0	Pirani defective.	Replace the measuring chamber cpl. (→ 50).
	blinking red	off	0	EEPROM error.	Switch the gauge off and on again after 5 s.
					Replace the gauge.
Signal continually at approx. $5 \times 10^{-4}$ mbar.	lid solid green	lid solid green	14.5 ... 30 V	Measuring chamber severely contaminated.	Replace the measuring chamber cpl. (→ 50).

## 7 Returning the Product



### WARNING

#### Forwarding contaminated products

Contaminated products (e.g. radioactive, toxic, caustic or microbiological hazard) can be detrimental to health and environment.

Products returned to INFICON should preferably be free of harmful substances. Adhere to the forwarding regulations of all involved countries and forwarding companies and enclose a duly completed declaration of contamination<sup>\*)</sup>.

<sup>\*)</sup> Form under [www.inficon.com](http://www.inficon.com)

Products that are not clearly declared as "free of harmful substances" are decontaminated at the expense of the customer. Products not accompanied by a duly completed declaration of contamination are returned to the sender at his own expense.

## 8 Disposal

### DANGER



Contaminated parts

Contaminated parts can be detrimental to health and environment.

Before beginning to work, find out whether any parts are contaminated. Adhere to the relevant regulations and take the necessary precautions when handling contaminated parts.



### WARNING



Substances detrimental to the environment

Products or parts thereof (mechanical and electric components, operating fluids etc.) can be detrimental to the environment.

Dispose of such substances in accordance with the relevant local regulations.

### Separating the components

After disassembling the product, separate its components according to the following criteria:

- Contaminated components  
Contaminated components (radioactive, toxic, caustic or biological hazard etc.) must be decontaminated in accordance with the relevant national regulations, separated according to their materials, and disposed of.
- Other components  
Such components must be separated according to their materials and recycled.



## 9 Options

	Ordering No.
Seal with centering ring and fine filter, DN 25 ISO-KF (stainless steel)	211-098
Baffle (optical tight) with centering ring and seal, DN 25 ISO-KF	211-113
Baffle, DN 25 ISO-KF, DN 40 ISO-KF, DN 40 CF-x	353-512

## 10 Accessories

	Ordering No.
Mounting / removing tool for ignition aid	351-550

## 11 Spare Parts

When ordering spare parts, always indicate:

- all information on the product nameplate
- description and ordering number

## 11.1 Ignition aid for MAG5xx and MPG5xx

	Ordering No.
ignition aid (set of 10 pieces)	351-995

## 11.2 Ionization Chamber for MAG5xx and MPG5xx

	Ordering No.
ionization chamber stainless steel	351-555
ionization chamber Titanium	351-556

## 11.3 Measuring Chamber Cpl. (Spare Sensor)

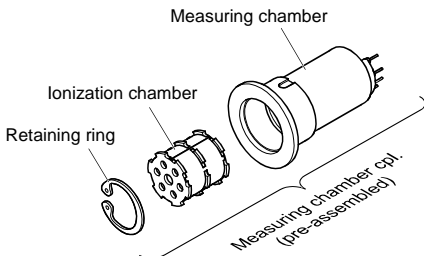

### 11.3.1 Measuring Chamber Cpl. for MAG5x0

	ionization chamber made of stainless steel		Ordering No.
MAG5x0	3MA0-006-xxxx	DN 25 ISO-KF	351-500
	3MA0-007-xxxx	DN 40 ISO-KF	351-512
	3MA0-008-xxxx	DN 40 CF-R	351-536
	3MA0-00Q-xxxx	DN 40 CF-F	351-524

Ionization chamber made of Titanium		Ordering No.	
MAG5x0	3MA0-116-xxxx	DN 25 ISO-KF	351-502
	3MA0-117-xxxx	DN 40 ISO-KF	351-514
	3MA0-118-xxxx	DN 40 CF-R	351-538
	3MA0-11Q-xxxx	DN 40 CF-F	351-526

### 11.3.2 Measuring Chamber Cpl. for MAG5x4

Ionization chamber made of stainless steel, Al <sub>2</sub> O <sub>3</sub> coated		Ordering No.	
MAG5x4	3MA3-006-xxxx	DN 25 ISO-KF	351-501
	3MA3-007-xxxx	DN 40 ISO-KF	351-513
	3MA3-008-xxxx	DN 40 CF-R	351-537
	3MA3-00Q-xxxx	DN 40 CF-F	351-525

Ionization chamber made of Titanium, Al <sub>2</sub> O <sub>3</sub> coated		Ordering No.	
MAG5x4	3MA3-116-xxxx	DN 25 ISO-KF	351-503
	3MA3-117-xxxx	DN 40 ISO-KF	351-515
	3MA3-118-xxxx	DN 40 CF-R	351-539
	3MA3-11Q-xxxx	DN 40 CF-F	351-527

### 11.3.3 Measuring Chamber Cpl. for MPG5x0

Ionization chamber made of stainless steel		Ordering No.	
MPG5x0	3MB0-006-xxxx	DN 25 ISO-KF	351-506
	3MB0-007-xxxx	DN 40 ISO-KF	351-518
	3MB0-008-xxxx	DN 40 CF-R	351-542
	3MB0-00Q-xxxx	DN 40 CF-F	351-530



Ionization chamber made of Titanium			Ordering No.
MPG5x0	3MB0-116-xxxx	DN 25 ISO-KF	351-508
	3MB0-117-xxxx	DN 40 ISO-KF	351-520
	3MB0-118-xxxx	DN 40 CF-R	351-544
	3MB0-11Q-xxxx	DN 40 CF-F	351-532

### 11.3.4 Measuring Chamber Cpl. for MPG5x4

Ionization chamber made of stainless steel, Al <sub>2</sub> O <sub>3</sub> coated			Ordering No.
MPG5x4	3MB3-006-xxxx	DN 25 ISO-KF	351-507
	3MB3-007-xxxx	DN 40 ISO-KF	351-519
	3MB3-008-xxxx	DN 40 CF-R	351-543
	3MB3-00Q-xxxx	DN 40 CF-F	351-531

Ionization chamber made of Titanium, Al <sub>2</sub> O <sub>3</sub> coated			Ordering No.
MPG5x4	3MB3-116-xxxx	DN 25 ISO-KF	351-509
	3MB3-117-xxxx	DN 40 ISO-KF	351-521
	3MB3-118-xxxx	DN 40 CF-R	351-545
	3MB3-11Q-xxxx	DN 40 CF-F	351-533

## Literature

-  [1] [www.inficon.com](http://www.inficon.com)  
 Communication Protocol  
 RS232C / RS485C  
 MAG500, MAG504, MPG500, MPG504  
 tira83e1 (English only)  
 INFICON AG, LI-9496 Balzers, Liechtenstein
-  [2] [www.inficon.com](http://www.inficon.com)  
 Communication Protocol  
 EtherCAT  
 MAG550, MAG554, MPG550, MPG554  
 tirb38e1 (English only)  
 INFICON AG, LI-9496 Balzers, Liechtenstein

## ETL Certification

RECOGNIZED  
COMPONENT



Intertek  
3103457

ETL LISTED

The products MAG500, MAG504, MAG550, MAG554, MPG500, MPG504, MPG550 and MPG554 with FCC and D-sub connector

- conform to the UL Standard UL 61010-1
- are certified to the CAN/CSA Standard C22.2 No. 61010-1-12

## EU Declaration of Conformity



We, INFICON, hereby declare that the equipment mentioned below complies with the provisions of the following Directives:

- 2014/30/EU, OJ L 96/79, 29.3.2014  
(EMC Directive; Directive relating to electromagnetic compatibility)
- 2011/65/EU, OJ L 174/88, 1.7.2011  
(RoHS Directive; Directive on the restriction of the use of certain hazardous substances in electrical and electronic equipment)

### Cold Cathode & Cold Cathode Pirani Gauge

Gemini MAG500, MAG504, MAG550, MAG554  
Gemini MPG500, MPG504, MPG550, MPG554

#### Standards

Harmonized and international / national standards and specifications:

- EN 61000-6-2:2005 (EMC: generic immunity standard)
- EN 61000-6-3:2007 + A1:2011 (EMC: generic emission standard)
- EN 61010-1:2010 (Safety requirements for electrical equipment for measurement, control and laboratory use)
- EN 61326-1:2013; Group 1, Class B (EMC requirements for electrical equipment for measurement, control and laboratory use)

#### Manufacturer / Signatures

INFICON AG, Alte Landstraße 6, LI-9496 Balzers

10 December 2018

10 December 2018



Dr. Bernhard Andreus  
Director Product Evolution

Markus Truniger  
Product Manager

## Notes

Original: German tina83d1-d (2018-12)



tina83e1-d



LI-9496 Balzers  
Liechtenstein  
Tel +423 / 388 3111  
Fax +423 / 388 3700  
reachus@inficon.com

[www.inficon.com](http://www.inficon.com)