

Pirani Standard Gauge

PSG550

PSG552

PSG554

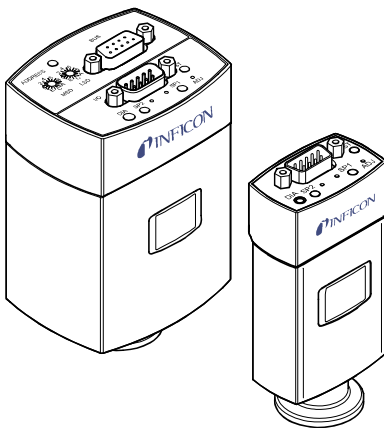



CE

Operating Manual
Incl. EC Declaration of Conformity

Product Identification

In all communications with INFICON, please specify the information given on the product nameplate. For convenient reference copy that information into the space provided below.

INFICON AG, LI-9496 Balzers		CE
Model: _____		
PN: _____		
SN: _____		
_____ V _____ W; LPS	  	
	3703457	

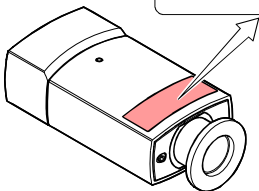

Validity

This document applies to products of the PSG55x series.

Part numbers of standard products are indicated below. OEM products have other part numbers and different parameter settings (e.g. factory setting of setpoint) as defined in the corresponding ordering information.

3PIx-0xx-xxxx

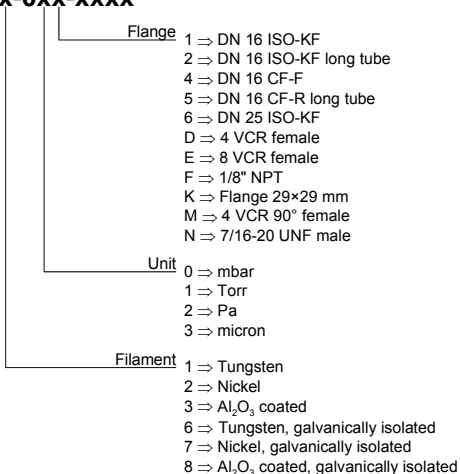

3PIx-0xx-xxxx

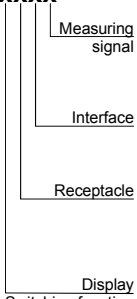
	Measuring signal	0 ⇒ 0.61 ... 10 V
		1 ⇒ 1.2 ... 8.5 V
		2 ⇒ 0.375 ... 5.529 V
		3 ⇒ 1.57 ... 8.875 V
	Interface	0 ⇒ None (analoge)
		1 ⇒ DeviceNet
		2 ⇒ Profibus
	Receptacle	0 ⇒ FCC
		1 ⇒ D-Sub, 9-pin
		2 ⇒ D-Sub, 15-pin HD
		4 ⇒ D-Sub, 15-pin HD, RS485 INF
	Display	0 ⇒ None
	Switching function	1 ⇒ Display
		2 ⇒ 2 switching functions *)
		4 ⇒ Display & 2 switching functions *)
		6 ⇒ 2 switching functions **)

*) Solid state relays

**) Mechanical relays

The part number (PN) can be taken from the product nameplate.

If not indicated otherwise in the legends, the illustrations in this document correspond to gauges with the DN 16 ISO-KF vacuum connection and display. They apply to gauges with other vacuum connections by analogy.

We reserve the right to make technical changes without prior notice.

Intended Use

The Pirani Standard Gauge PSG55x has been designed for vacuum measurement of gases in the pressure range of 5×10^{-5} ... 1000 mbar.

They must not be used for measuring flammable or combustible gases in mixtures containing oxidants (e.g. atmospheric oxygen) within the explosion range.

The gauge is intended for operation in connection with an INFICON Vacuum Gauge Controller VCG401, 402, 403 or with another suitable controller.

Trademark

VCR[®] Swagelok Marketing Co.

Patents

EP 0689669 B1, 0689670 B1

US Patent 5608168



Scope of Delivery

- 1× gauge
- 1× pin for adjusting settings via buttons
- 1× Operating Manual English
- 1× Operating Manual German

Contents

Product Identification	2
Validity	3
Intended Use	5
Trademark	5
Patents	5
Scope of Delivery	5
1 Safety	8
1.1 Symbols Used	8
1.2 Personnel Qualifications	8
1.3 General Safety Instructions	9
1.4 Liability and Warranty	9
2 Technical Data	10
2.1 Output Signal vs. Pressure	18
2.2 Gas Type Dependence	23
3 Installation	24
3.1 Vacuum Connection	24
3.2 Power Connection	27
3.2.1 FCC 68, 8-pin Connector	28
3.2.2 D-Sub, 9-pin Connector	29
3.2.3 D-Sub, 15-pin HD Connector	30
3.2.4 D-Sub, 15-pin HD, RS485 INF Connector	31
3.2.5 DeviceNet Connector	32
3.2.6 Profibus Connector	33
4 Operation	34
4.1 Status Indication and Displays	34
4.2 Gas Type Dependence	38
4.3 Switching Functions SP1, SP2	38
4.4 Diagnostic Port (RS232C Interface)	44
4.5 DeviceNet Operation	45
4.6 Profibus Operation	48
5 Deinstallation	49

6 Maintenance, Repair	51
6.1 Adjusting the Gauge	51
6.2 Replacing the Sensor	53
6.3 Troubleshooting	54
7 Returning the Product	55
8 Disposal	56
9 Accessories	57
10 Spare Parts	58
Further Information	61
ETL Certification	62
EC Declaration of Conformity	63

For cross-references within this document, the symbol (→  XY) is used, for cross-references to further documents, listed under "Further Information", the symbol (→  [Z]).

1 Safety

1.1 Symbols Used



DANGER

Information on preventing any kind of physical injury.



WARNING

Information on preventing extensive equipment and environmental damage.



Caution

Information on correct handling or use. Disregard can lead to malfunctions or minor equipment damage.



Notice



Labeling

1.2 Personnel Qualifications



Skilled personnel

All work described in this document may only be carried out by persons who have suitable technical training and the necessary experience or who have been instructed by the end-user of the product.

1.3 General Safety Instructions

- Adhere to the applicable regulations and take the necessary precautions for the process media used.
Consider possible reactions with the product materials.
Consider possible reactions (e.g. explosion) of the process media due to the heat generated by the product.
- Adhere to the applicable regulations and take the necessary precautions for all work you are going to do and consider the safety instructions in this document.
- Before beginning to work, find out whether any vacuum components are contaminated. Adhere to the relevant regulations and take the necessary precautions when handling contaminated parts.

Communicate the safety instructions to all other users.

1.4 Liability and Warranty

INFICON assumes no liability and the warranty becomes null and void if the end-user or third parties

- disregard the information in this document
- use the product in a non-conforming manner
- make any kind of interventions (modifications, alterations etc.) on the product
- use the product with accessories not listed in the product documentation.

The end-user assumes the responsibility in conjunction with the process media used.

Gauge failures due to contamination or wear and tear, as well as expendable parts (e.g. filament) are not covered by the warranty.

2 Technical Data



For further technical data for gauges with serial interfaces →  [3], [4], [5].

Measurement principle	thermal conductance acc. to Pirani
Measurement range	5×10^{-5} ... 1000 mbar
Accuracy (N ₂)	
5×10^{-4} ... 1×10^{-3} mbar	±50% of reading
1×10^{-3} ... 100 mbar	±15% of reading
100 ... 1000 mbar	±50% of reading
Resolution (at 1000 mbar)	±0.15% of reading
Repeatability (N ₂)	
1×10^{-3} ... 100 mbar	±2% of reading

Output signal (measurement signal)

Voltage range

3Plx-0xx-xxx0	0 ... +10 V
3Plx-0xx-xxx1	0 ... +8.5 V
3Plx-0xx-xxx2	0 ... +5.529 V
3Plx-0xx-xxx3	0 ... +8.875 V

Measurement range

3Plx-0xx-xxx0	+0.61 ... +10 V
3Plx-0xx-xxx1	+1.2 ... +8.5 V
3Plx-0xx-xxx2	+0.375 ... +5.529 V
3Plx-0xx-xxx3	+1.57 ... +8.875 V

Error signal

0 ... 0.05 V



Voltage vs. pressure

3Plx-0xx-xxx0	1.286 V/decade, logarithmic
3Plx-0xx-xxx1	1 V/decade, logarithmic
3Plx-0xx-xxx3	1 V/decade, logarithmic
3Plx-0xx-xxx2	→  20

Output impedance	2 × 4.7 Ω, short circuit-proof
Load impedance	≥10 kΩ
Response time	<10 ms
<hr/>	
Gauge identification	
FCC 68 (+0.61 ... +10 V)	27 kΩ
HV adjustment	at <10 ⁻⁵ mbar
<hr/>	
Solid state relays	switching functions SP1, SP2, ATM
Setting range (N ₂)	5.0×10 ⁻⁵ ... 1000 mbar
Hysteresis ¹⁾	10% of threshold
Switching characteristics ¹⁾	Low Trip Point
Contact rating	<30 VAC/DC, ≤0.3 A resistive
closed	LED lit solid
open	LED off
Switching time	<30 ms
<hr/>	
Mechanical relays	switching functions SP1, SP2, ATM
Setting range (N ₂)	5.0×10 ⁻⁵ ... 1000 mbar
Hysteresis ¹⁾	10% of threshold
Switching characteristics ¹⁾	Low Trip Point
Type	1 floating contact (n.o.) per switching function
Contact rating	<30 VAC/DC, ≤1 A resistive
closed	LED lit solid
open	LED off
Switching time	<30 ms
<hr/>	
Diagnostic port	Jack connector 2.5 mm, 3-pin
<hr/>	

¹⁾ The hysteresis and the switching characteristics can be programmed via the serial interface or the diagnostic port.

Supply

	 DANGER
<p>The gauge may only be connected to power supplies, instruments, or control devices that conform to the requirements of a grounded protective extra-low voltage (SELV) and limited power source (LPS), Class 2. The connection to the gauge has to be fused. ²⁾</p>	

Supply voltage at the gauge	Class 2 / LPS +15 ... +30 VDC
Ripple	$\leq 1 V_{pp}$
Power consumption without fieldbus	$\leq 2.5 W$
DeviceNet	$\leq 3 W$
Profibus	$\leq 3 W$
Fuse to be connected ²⁾	1 AT
<hr/>	
Electrical connection	
3PIx-0xx-x0xx	FCC 68
3PIx-0xx-x1xx	D-Sub 9-pin, male
3PIx-0xx-x2xx	D-Sub 15-pin HD, male
3PIx-0xx-x4xx	D-Sub 15-pin HD, RS485 INF, male
Sensor cable	shielded 0.14 mm ² /conductor
Cable length	$\leq 100 m$
RS232C operation	$\leq 30 m$
<hr/>	
Grounding concept	→ "Power Connection"
Vacuum connection to signal common	connected via 10 k Ω , 10 nF

²⁾ INFICON controllers fulfill this requirement.

RS232C / RS485 interface

Transmission rate	57600 baud (default)
Data format	binary 8 data bits one stop bit no parity bit no handshake → "Power Connection"

For further information on the RS232C / RS485C interface

→  [3].



DeviceNet interface

Specification, data format,
communication protocol →  [6]

Interface, physical CAN bus

Data rate (adjustable via <RATE>
switch) 125 kBaud
250 kBaud
500 kBaud (default)
<P> (125 kBaud,
250 kBaud, 500 kBaud
programmable via
DeviceNet, →  [4])







Node address (MAC ID)
(Adjustable via <ADDRESS>,
<MSD>, <LSD> switches) 0 ... 63dec (63dec default)
<P> (0 ... 63 programmable
via DeviceNet, →  [4])

DeviceNet connector Micro-Style, 5-pin, male
Cable shielded, special DeviceNet
cable, 5 conductors
→  32, →  [7]

Cable length, system wiring according to DeviceNet
specifications, →  [6], [7]

For further information on the DeviceNet interface →  [4]

Profibus interface

Specification, data format, communication protocol	→  [8]
Interface, physical	RS485
Data rate	≤12 Mbaud (→  [5])
Node address	
Local (Adjustable via hexadecimal <ADDRESS>, <MSD>, <LSD> switches)	00 ... 7D _{hex} (0 ... 125 _{dec})
Default setting	01C _{hex}
Via Profibus (hexadecimal <ADDRESS> switches set to >7D _{hex} (>125 _{dec}))	00 ... 7D _{hex} (0 ... 125 _{dec})
Profibus connection	D-Sub, 9-pin, female
Cable	shielded, special Profibus cable, →  33, →  [9]
Cable length, system wiring	according to Profibus speci- fications, →  [8], [9]
For further information on the Profibus interface →  [5]	

Materials exposed to vacuum

Vacuum connection	stainless steel 1.4435
Filament	
3P11 / 6-0xx-xxxx	W
3P12 / 7-0xx-xxxx	Ni
3P13 / 8-0xx-xxxx	ceramic coated
Feedthrough	glass
Orifice ³⁾	stainless steel
Further materials	Ni, NiFe, stainless steel 1.4301

³⁾ Only versions DN 16 ISO-KF and DN 16 CF-F.

Internal volume	
DN 16 ISO-KF	4.7 cm ³
DN 16 ISO-KF, long tube	14.5 cm ³
DN 16 CF-F	8 cm ³
DN 16 CF-R, long tube	14 cm ³
DN 25 ISO-KF	5.5 cm ³
4 VCR [®] female	5.5 cm ³
8 VCR [®] female	7 cm ³
1/8" NPT	5.2 cm ³
Flange 29×29 mm	4.9 cm ³
4 VCR [®] 90°, female	7.9 cm ³
7/16-20 UNF	5.2 cm ³
<hr/>	
Permissible pressure (absolute)	≤5 bar
Bursting pressure (absolute)	10 bar
<hr/>	
Permissible temperatures	
Operation	+10 °C ... +50 °C
Vacuum connection ⁴⁾	≤80 °C
long tube ⁴⁾	≤250 °C
Filament	<160 °C
Storage	-20 °C ... +65 °C
Relative humidity	
Year's mean	≤65% (no condensation)
During 60 days	≤85% (no condensation)
Mounting orientation	any
Use	indoors only, altitude up to 2000 m NN
Degree of protection	IP 40
<hr/>	
Weight	
without fieldbus interface	115 g ... 130 g
with fieldbus interface	230 g ... 250 g
<hr/>	

⁴⁾ For horizontal mounting orientation only. During bakeout, measurement range, accuracy, and repeatability may deviate from specifications.

Dimensions [mm]

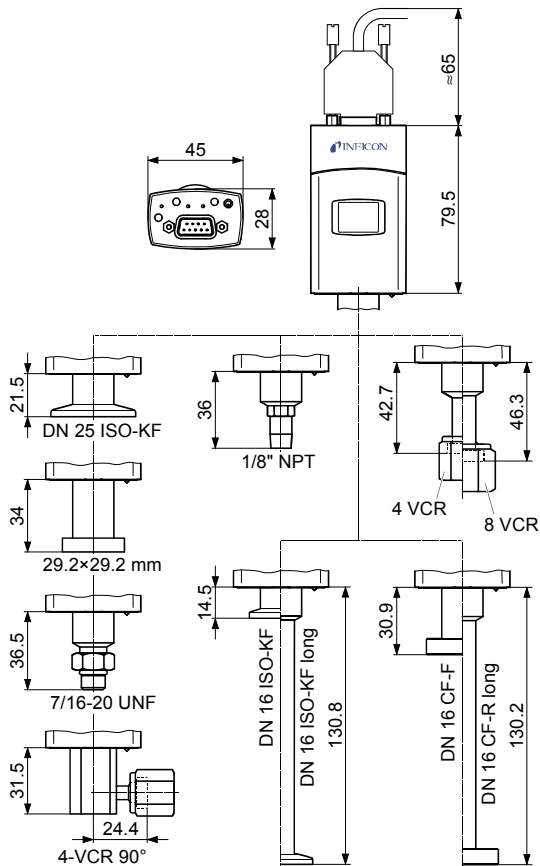

DeviceNet

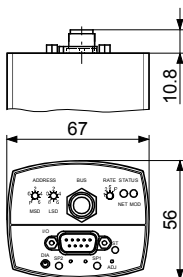

Profibus

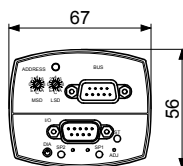

RS485

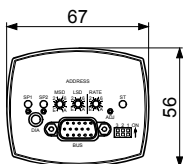

2.1 Output Signal vs. Pressure

Measurement range 0.61 ... 10 V

Pressure p

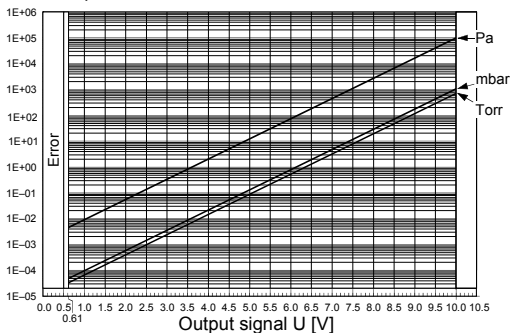

$$p = 10^{0.778(U-c)} \quad \Leftrightarrow \quad U = c + 1.286 \log_{10} p$$

valid in the range 5×10^{-5} mbar < p < 1000 mbar

U	p	c	U	p	c
[V]	[mbar]	6.143	[V]	[micron]	2.448
[V]	[μ bar]	2.287	[V]	[Pa]	3.572
[V]	[Torr]	6.304	[V]	[kPa]	7.429
[V]	[mTorr]	2.448			

where p pressure
 U output signal
 c constant (pressure unit dependent)

Measurement range 1.2 ... 8.5 V

Pressure p

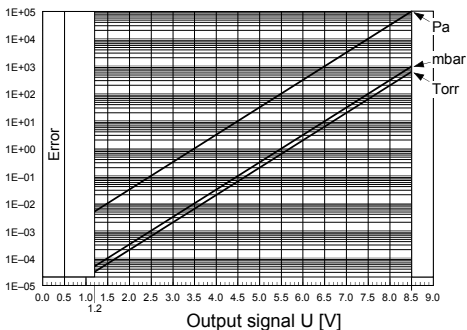

$$p = 10^{(U-c)} \quad \Leftrightarrow \quad U = c + \log_{10} p$$

valid in the range $5 \times 10^{-5} \text{ mbar} < p < 1000 \text{ mbar}$

U	p	c	U	p	c
[V]	[mbar]	5.5	[V]	[micron]	2.625
[V]	[μ bar]	2.5	[V]	[Pa]	3.5
[V]	[Torr]	5.625	[V]	[kPa]	6.5
[V]	[mTorr]	2.625			

where p pressure
 U output signal
 c constant (pressure unit dependent)

Measurement range 0.375 ... 5.529 V

Signal U [V]	Pressure p		
	[mbar]	[Pa]	[Torr]
0.375	$<5 \times 10^{-5}$	$<6.65 \times 10^{-3}$	$<5 \times 10^{-5}$
0.376	0.000133322	0.013332237	0.0001
0.377	0.000266645	0.026664474	0.0002
0.379	0.000666612	0.066661184	0.0005
0.384	0.001333224	0.133322368	0.0010
0.392	0.002666447	0.266644736	0.0020
0.417	0.006666118	0.66661184	0.0050
0.455	0.013332237	1.33322368	0.0100
0.523	0.026664474	2.66644736	0.0200
0.682	0.066661184	6.6661184	0.0500
0.876	0.133322368	13.3322368	0.1000
1.155	0.266644736	26.6644736	0.2000
1.683	0.66661184	66.661184	0.5000
2.217	1.33322368	133.322368	1.0000
2.842	2.66644736	266.644736	2.0000
3.675	6.6661184	666.61184	5.0000
4.206	13.3322368	1333.22368	10.0000
4.577	26.6644736	2666.44736	20.0000
4.846	66.661184	6666.1184	50.0000
4.945	133.322368	13332.2368	100.0000
5.019	266.644736	26664.4736	200.0000
5.111	399.967104	39996.7104	300.0000
5.224	533.289472	53328.9472	400.0000
5.329	666.61184	66661.184	500.0000
5.419	799.934208	79993.4208	600.0000
5.495	933.256576	93325.6576	700.0000
5.529	1000	100000	750.0637

Valid in the range 0.375 ... 2.842 V

$$p = a + bU + cU^2 + dU^3 + eU^4 + fU^5$$

a	-0.02585	c	0.04563	e	-0.04158
b	0.03767	d	0.1151	f	0.008737

where p pressure in Torr a, b, c, d, e, f constant
 U output signal

Valid in the range 2.842 ... 4.945 V

$$p = \frac{a + cU + eU^2}{1 + bU + dU^2 + fU^3}$$

a	0.1031	c	-0.02322	e	0.07229
b	-0.3986	d	0.07438	f	-0.006866

where p pressure in Torr a, b, c, d, e, f constant
 U output signal

Valid in the range 4.945... 5.529 V

$$p = \frac{a + cU}{1 + bU + dU^2}$$

a	100.624	c	-20.5623
b	-0.37679	d	0.0348656

where p pressure in Torr a, b, c, d constant
 U output signal

Measurement range 1.57 ... 8.875 V

Pressure p

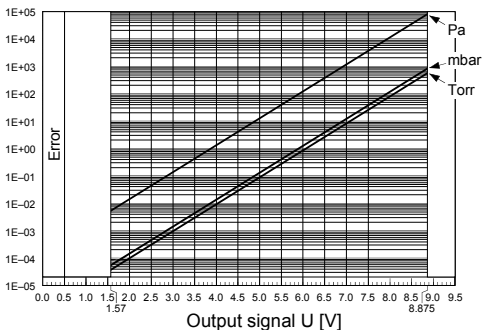

$$p = 10^{(U-c)} \quad \Leftrightarrow \quad U = c + \log_{10} p$$

valid in the range $5 \times 10^{-5} \text{ mbar} < p < 1000 \text{ mbar}$

U	p	c	U	p	c
[V]	[mbar]	5.8751	[V]	[micron]	3
[V]	[μbar]	2.8751	[V]	[Pa]	3.8751
[V]	[Torr]	6	[V]	[kPa]	6.8751
[V]	[mTorr]	3			

where p pressure
 U output signal
 c constant (pressure unit dependent)

2.2 Gas Type Dependence

Indicated pressure (gauge calibrated for air)

p (mbar)

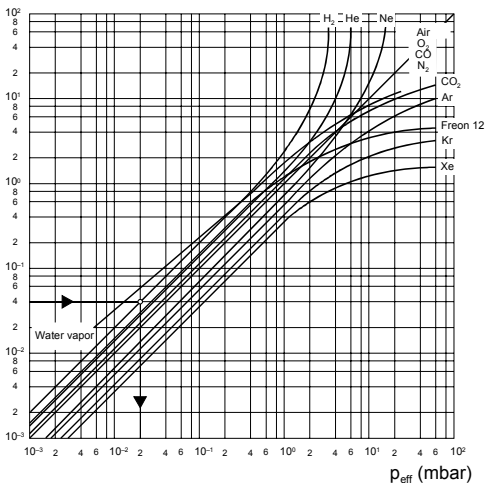

Calibration factors

valid for Pirani pressure range below 1 mbar

$$p_{\text{eff}} = C \times \text{indicated pressure}$$

Gas type	Calibration factor C	Gas type	Calibration factor C
He	0.8	H ₂	0.5
Ne	1.4	air, O ₂ , CO, N ₂	1.0
Ar	1.7	CO ₂	0.9
Kr	2.4	water vapor	0.5
Xe	3.0	Freon 12	0.7

3 Installation

3.1 Vacuum Connection



DANGER

DANGER: overpressure in the vacuum system
>1 bar

Injury caused by released parts and harm caused by escaping process gases can result if clamps are opened while the vacuum system is pressurized.

Do not open any clamps while the vacuum system is pressurized. Use the type clamps which are suited to overpressure.



DANGER

DANGER: overpressure in the vacuum system
>2.5 bar

KF flange connections with elastomer seals (e.g. O-rings) cannot withstand such pressures. Process media can thus leak and possibly damage your health.

Use O-rings provided with an outer centering ring.



DANGER



DANGER: protective ground

Products that are not correctly connected to ground can be extremely hazardous in the event of a fault.

Electrically connect the gauge to the grounded vacuum chamber. This connection must conform to the requirements of a protective connection according to EN 61010:

- CF, NPT, UNF and VCR flanges fulfill this requirement.
- For gauges with a KF flange, use a conductive metallic clamping ring.
- For gauges with a 1/2" tube and a 29×29 mm flange, take appropriate measures to fulfill this requirement.



Caution



Caution: vacuum component

Dirt and damages impair the function of the vacuum component.

When handling vacuum components, take appropriate measures to ensure cleanliness and prevent damages.



Caution



Caution: dirt sensitive area

Touching the product or parts thereof with bare hands increases the desorption rate.

Always wear clean, lint-free gloves and use clean tools when working in this area.



Mount the gauge so that no vibrations occur. The gauge may be mounted in any orientation. To keep condensates and particles from getting into the measuring chamber preferably choose a horizontal to upright position and consider using a seal with centering ring and filter. If adjustment should be possible after the gauge has been installed, be sure to install it so that the buttons can be accessed with a pin.

Remove the protective lid and connect the product to the vacuum system.

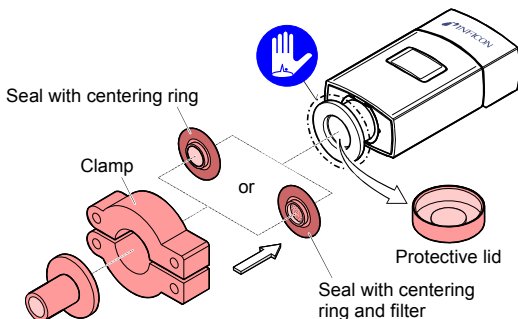

Keep the protective lid.

3.2 Power Connection



Make sure the vacuum connection is properly made (→  24).



DANGER



The gauge may only be connected to power supplies, instruments or control devices that conform to the requirements of a grounded protective extra-low voltage (SELV) and limited power source (LPS), Class 2. The connection to the gauge has to be fused.⁵⁾



Ground loops, differences of potential, or EMC problems may affect the measurement signal. For optimum signal quality, please do observe the following notes:

- Connect the cable shield to ground on one side via the connector housing. Do not connect the other side of the shield.
- Connect the supply common with protective ground directly at the power supply.
- Use differential measurement input (signal common and supply common conducted separately).
- Potential difference between supply common and housing ≤ 18 V (overvoltage protection).

⁵⁾ INFICON controllers fulfill these requirements.

3.2.1 FCC 68, 8-pin Connector

If no sensor cable is available, make one according to the following diagram. Connect the sensor cable.

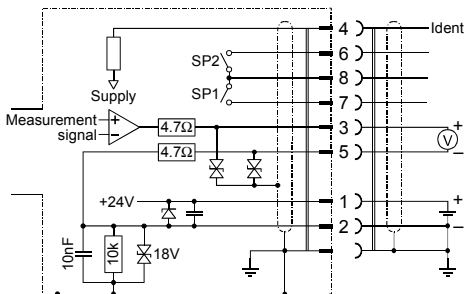

Electrical connection

- Pin 1 Supply
- Pin 2 Supply common, GND
- Pin 3 Measurement signal or threshold SP1, SP2
- Pin 4 Gauge identification
- Pin 5 Signal common
- Pin 6, 8 Relay SP2
Common closing contact (com)
- Pin 7, 8 Relay SP1
Common closing contact (com)

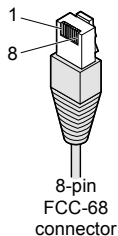

3.2.2 D-Sub, 9-pin Connector

If no sensor cable is available, make one according to the following diagram. Connect the sensor cable.

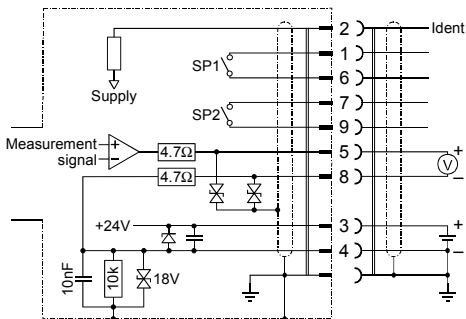

Electrical connection

- Pin 1 Relay SP1, closing contact
- Pin 2 Gauge identification
- Pin 3 Supply
- Pin 4 Supply common, GND
- Pin 5 Measurement signal or thresholds SP1, SP2
- Pin 6 Relay SP1 Common contact (com)
- Pin 7 Relay SP2 Common contact (com)
- Pin 8 Signal common
- Pin 9 Relay SP2, closing contact

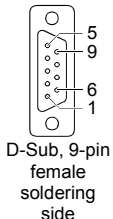

3.2.3 D-Sub, 15-pin HD Connector

If no sensor cable is available, make one according to the following diagram. Connect the sensor cable.

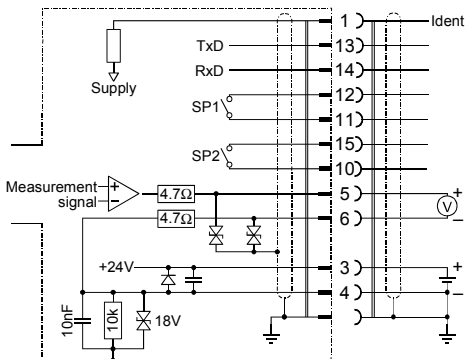

Electrical connection

Pin 1,2	Gauge identification
Pin 2	N.C.
Pin 3	Supply
Pin 4	Supply common
Pin 5	Measurement signal
Pin 6	Signal common
Pin 7,8,9	N.C
Pin 10	Relay SP1, N.O.
Pin 11	Relay SP2, N.O.
Pin 12	Relay SP2
	Common contact (com)
Pin 13	RS232, TxD
Pin 14	RS232, RxD
Pin 15	Relay SP1
	Common contact (com)

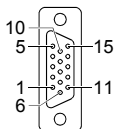

D-Sub
15-pin HD
female
soldering
side

3.2.4 D-Sub, 15-pin HD, RS485 INF Connector

If no sensor cable is available, make one according to the following diagram. Connect the sensor cable.

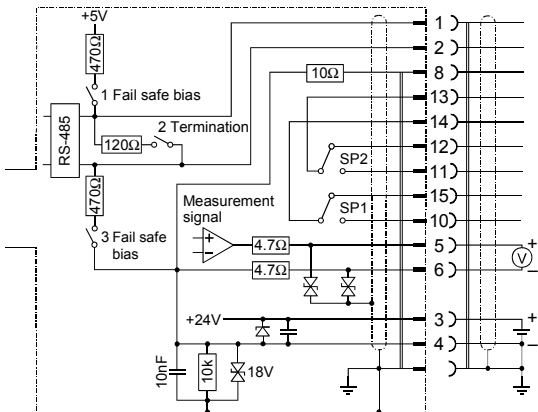

Electrical connection

- Pin 1 RS485 B+
- Pin 2 RS485 A-
- Pin 3 Supply
- Pin 4 Supply common
- Pin 5 Measurement signal
- Pin 6 Signal common
- Pin 7 Reserved
- Pin 8 RS485 GND
- Pin 9 Reserved
- Pin 10 Relay SP1, N.O.
- Pin 11 Relay SP2, N.O.
- Pin 12 Relay SP2, common contact (com)
- Pin 13 Relay SP2, N.C.
- Pin 14 Relay SP1, N.C.
- Pin 15 Relay SP1, common contact (com)

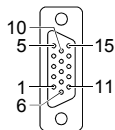

D-Sub
15-pin HD
female
soldering
side

3.2.5 DeviceNet Connector

If no DeviceNet cable is available, make one according to the following diagram. Connect the DeviceNet cable.

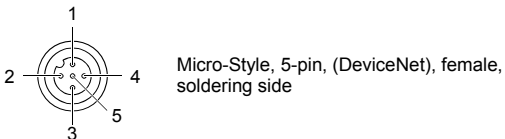

Pin 1	Drain	
Pin 2	Supply	+15 ... +30 VDC
Pin 3	Supply common	GND
Pin 4	CAN_H	
Pin 5	CAN_L	

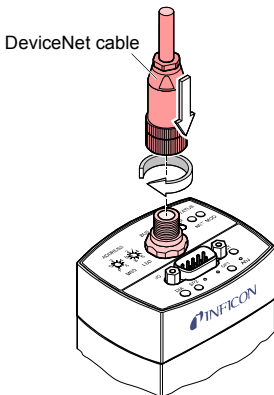

3.2.6 Profibus Connector

If no Profibus cable is available, make one according to the following diagram. Connect the Profibus cable.

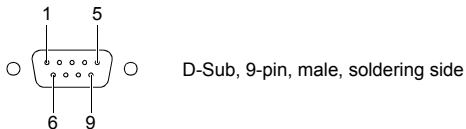

Pin 1, 2	Do not connect	Pin 6	VP ²⁾
Pin 3	RxD/TxD-P	Pin 7, 9	Not connected
Pin 4	CNTR-P ¹⁾	Pin 8	RxD/TxD-N
Pin 5	DGND ²⁾		

¹⁾ Only to be connected if an *optical link* module is used.

²⁾ Only required as line termination for devices at both ends of bus cable (→  [9]).

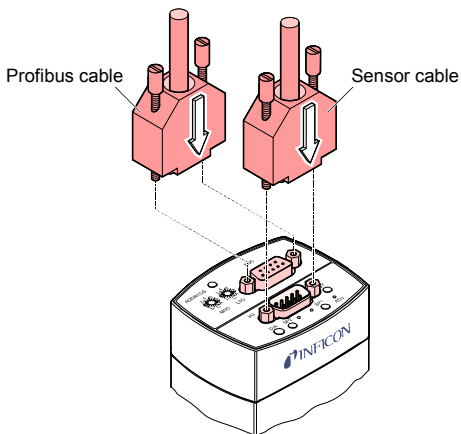

4 Operation

When the supply voltage is applied, the measurement signal is available at the connector (→ "Power Connection").

Allow a stabilization period of at least 10 minutes. It is advisable to operate the gauge continuously, irrespective of the pressure.

The gauge is factory calibrated. Due to long time operation or contamination, a zero drift could occur. Periodically check the zero and adjust it if necessary (adjusting the gauge → 51).

4.1 Status Indication and Displays

Light-emitting diodes (LEDs)

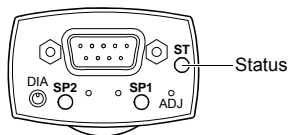

LED	State	Meaning
<ST>	off	no supply voltage
	lit green	measurement mode
	lit red	error
<SP1>	lit green	Relay SP 1 closed
	off	Relay SP 1 open
<SP2>	lit green	Relay SP 2 closed
	off	Relay SP 2 open

Liquid crystal display (LCD)

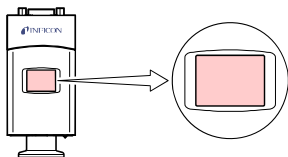

LCD	Meaning
off	no supply voltage
lit green	measurement / parameter mode
lit red	error



The display can be rotated by 180 ° via the diagnostic port.

Put the gauge into operation

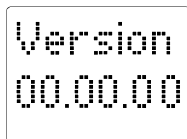

When the supply voltage is applied the software version is briefly displayed.

Measurement mode

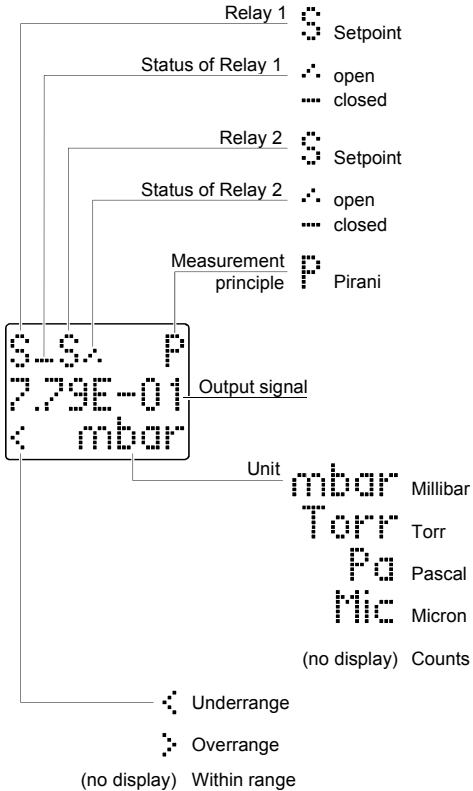

Parameter mode

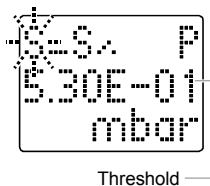

Switching functions <S>

When the <SP1> or <SP2> button is pushed, the corresponding threshold is displayed and the corresponding relay flashes.

Error display (trouble shooting → 54)



Pirani sensor error



EEPROM error

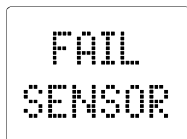

Sensor error

4.2 Gas Type Dependence

The measurement value is gas dependent. The pressure reading applies to dry air, O², CO and N². For other gases, it has to be corrected (→ "Technical Data").

If the gauge is operated with an INFICON controller, a calibration factor for correction of the actual reading can be applied (→  of the corresponding controller).

4.3 Switching Functions SP1, SP2

The two switching functions can be set to any pressure within the measurement range of the gauge. A solid state relay is provided for each switching function.

The current threshold setting

- can be read / written via the diagnostic port
- is output at the measurement signal output instead of the pressure signal, can be measured with a voltmeter, and is displayed on the LCD display after the <SP1> or <SP2> button is pressed
- can be read / written via the DeviceNet, Profibus and RS485 interface.

Switching characteristics and hysteresis

The switching characteristics and the hysteresis of each set point can be programmed (→  41).

Low Trip Point (default)

If the pressure in the vacuum system is lower than the setpoint, the corresponding LED (<SP1> or <SP2>) is lit solid and the corresponding relay is closed.

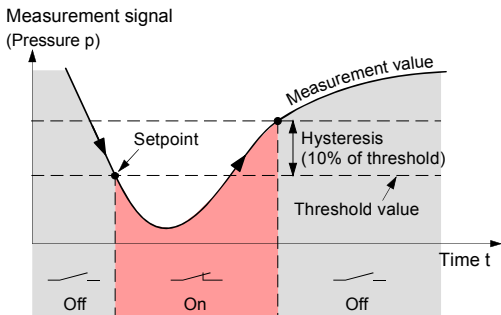

The setpoints SP1 and SP2 are factory set to the lower measurement range limit and therefore do not switch.

High Trip Point

If the pressure in the vacuum system is higher than the setpoint, the corresponding LED (<SP1> or <SP2>) is lit solid and the corresponding relay is closed.

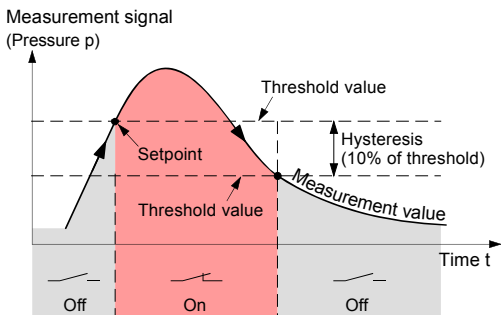

High & Low Trip Point

Both a High Trip Point and a Low Trip Point are assigned to each setpoint. If the pressure in the vacuum system is higher than the defined High Trip Point threshold, the corresponding LED (<SP1> or <SP2>) is lit and the corresponding relay is closed. If the pressure in the vacuum system is lower than the defined Low Trip Point threshold, the corresponding LED (<SP1> or <SP2>) is lit and the corresponding relay is closed.

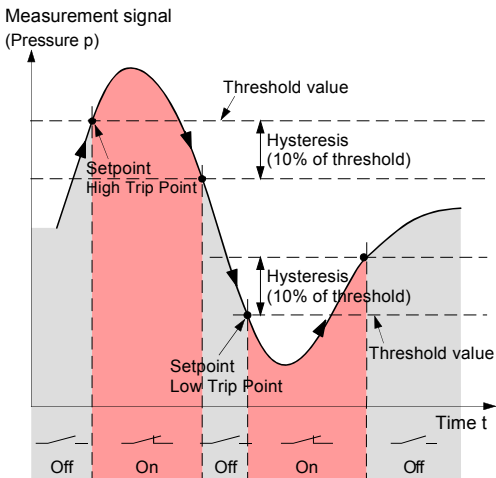



The setpoints can only be programmed via

- the diagnostic port (→ [3])
- the DeviceNet, Profibus and RS485 interface (→ [3], [4], [5]).

4.3.1 Adjusting the Setpoints SP1, SP2





The switching characteristics and the hysteresis can only be programmed via

- the diagnostic port (→  [3])
- the DeviceNet, Profibus and RS485 interface (→  [3], [4], [5]).



The thresholds of the setpoints can be adjusted via

- the buttons on the gauge
- the diagnostic port (→  [3])
- the DeviceNet, Profibus and RS485 interface (→  [3], [4], [5]).



If both a High Trip Point and a Low Trip Point are assigned to a setpoint, Low Trip Point only can be adjusted via the corresponding button on the gauge.



DANGER



DANGER: malfunction

If processes are controlled via the signal output, keep in mind that by pushing an <SP> button the measurement signal is suppressed and the corresponding threshold value is output instead. This can cause malfunctions.

Push the <SP> button only if you are sure that no damages can arise from a malfunction.

Adjusting setpoint SP1 with button on the gauge

- 1 Push the <SP1> button with a pin (max. $\varnothing 1.1$ mm) and keep it depressed. The gauge changes to the switching function mode and outputs the current threshold value at the measurement value output or on the LCD for about 5 s and the corresponding <S> on the display blinks.

The threshold setting is increased towards the upper limit until the button is released or the limit is reached.

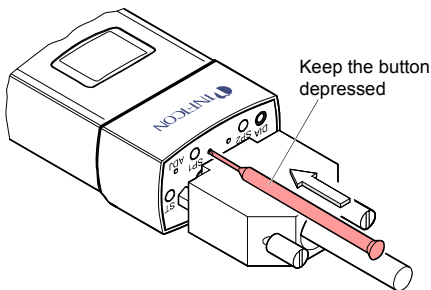

- 2 Push the <SP1> button again:

Fine adjustment within 0...1 s:	the threshold value changes by one unit
Change of direction within 2...3 s:	the threshold adjustment changes its direction

- 3 The <SP1> button is released for more than 5 s: the threshold value is saved and the gauge returns to the measurement mode.



The factory setting of the upper threshold is 10% above the Low Trip Point and 10% below the High Trip Point (hysteresis).

4.4 Diagnostic Port (RS232C Interface)

The diagnostic port <DIA> permits to output the pressure reading and all status information and to enter all settings at the same time (→  [3]).

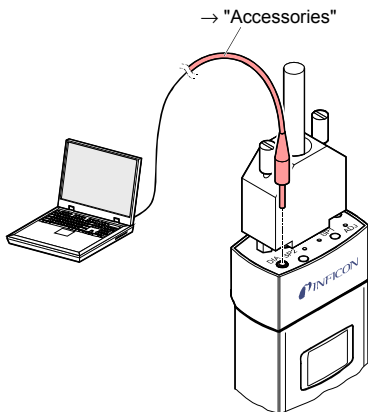

4.5 DeviceNet Operation

Caution



Caution: data transmission errors

The attempt to operate the DeviceNet gauge with the RS232C interface causes data transmission errors.

This DeviceNet gauge must not be operated with the RS232C interface.

Before the gauge is put into operation, it has to be configured for the DeviceNet. A configuration tool and the device specific EDS (Electronic Data Sheet) file are required for this purpose. This software can be downloaded from our website.

Node Address Setting

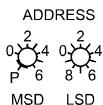

Set the node address (0 ... 63_{dec}) via the <ADDRESS>, <MSD>, and <LSD> switches (default 63_{dec}). The node address is polled by the firmware when the gauge is switched on. If the setting deviates from the stored value, the new value is taken over into the NVRAM. If a setting higher than 63 is made, the previous node address setting remains valid. If the <MSD> switch is in the <P> position, the node address is programmable via the DeviceNet (→  [4]).

Data Rate Setting



RATE By means of the <RATE> switch, the data rate can be set to 125 (<1>), 250 (<2>) or 500 kBaud (<5>) (default 500 kBaud).

If the switch is in the <P> position, the data rate is programmable via the DeviceNet (→  [4]).

Status LED

Two LEDs on the gauge inform on the gauge status and the current DeviceNet status.

<STATUS MOD> (gauge status):

LED	Meaning
off	No supply
blinking green-red	Selftest
lit solid green	Normal operation
lit solid red	Non recoverable error
blinking red	Recoverable error (e.g. missing DeviceNet power supply)

<STATUS NET> (network status):

LED	Meaning
off	Gauge not online: <ul style="list-style-type: none"> • Selftest not yet concluded • No supply, → "STATUS MOD"
blinking green	Gauge online but no communication: <ul style="list-style-type: none"> • Selftest concluded but no communication to other nodes established • Gauge not assigned to any master
lit solid green	Gauge online; necessary connections established
blinking red	One or several input / output connections in "time out" status
lit solid red	Communication error. The gauge has detected an error that impedes communication via the network (e.g. two identical node addresses (MAC IC) or "Bus-off")

4.6 Profibus Operation



Caution



Caution: data transmission errors
 The attempt to operate the gauge with the RS232C interface causes data transmission errors.
 This gauge must not be operated with the RS232C interface.

For operating the gauge via Profibus, prior installation of the device specific GSD file is required on the bus master side. This file can be downloaded from our website.

Node Address Setting

For unambiguous identification of the gauge in a Profibus environment, a node address is required.

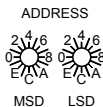

Node address 0 ... 125_{dec}

The node address is set in hexadecimal form (00 ... 7D_{hex}) via the <MSD> and <LSD> switches. It can not be defined via Profibus.

Node address >7D_{hex} (>125_{dec})

The gauge starts with the node address 126_{dec}. The address can now be set via Profibus ("Set slave address", →  [5]). Additionally, via the attribute "NO_ADD_CHG" can be defined, if further changes of the node address are permissible.

The values of the nude address and the attribute are stored non-volatile. To change these stored values, start the gauge with a node address <126_{dec}. The stored values of the nude address and the attribute are deleted.

5 Deinstallation

DANGER



DANGER: contaminated parts

Contaminated parts can be detrimental to health and environment.

Before beginning to work, find out whether any parts are contaminated. Adhere to the relevant regulations and take the necessary precautions when handling contaminated parts.



Caution



Caution: vacuum component

Dirt and damages impair the function of the vacuum component.

When handling vacuum components, take appropriate measures to ensure cleanliness and prevent damages.



Caution



Caution: dirt sensitive area

Touching the product or parts thereof with bare hands increases the desorption rate.

Always wear clean, lint-free gloves and use clean tools when working in this area.

- 1** Vent the vacuum system.
- 2** Put the gauge out of operation.

- 3 Untighten the fastening screw(s) and disconnect the sensor cable.
- 4 Remove gauge from the vacuum system and install the protective lid.

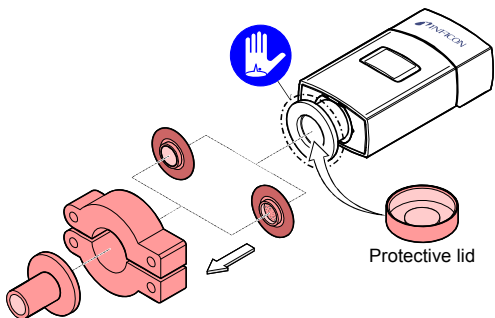

6 Maintenance, Repair



Gauge failures due to contamination and wear and tear, as well as expendable parts (e.g. filament), are not covered by the warranty.

INFICON assumes no liability and the warranty becomes null and void if any repair work is carried out by the end-user or third parties.

6.1 Adjusting the Gauge

The gauge is factory calibrated. Due to long time operation or contamination, a zero drift could occur. Periodically check the zero and adjust it if necessary.

For adjusting the zero, operate the gauge under the same constant ambient conditions and in the same mounting orientation as normally.

The gauge is adjusted to default values. However, it can also be adjusted to other pressure values, if the exact pressure value is known (reference measurement).

- 1** If you are using a seal with centering ring and filter, check that they are clean or replace them if necessary (→ "Deinstallation").
- 2** Put the gauge into operation and operate it at atmospheric pressure for at least 10 minutes.

- 3 Press the <ADJ> button with a pin (max. $\varnothing 1.1$ mm) and the ATM adjustment is carried out: The Pirani sensor is adjusted to 1000 mbar by default.

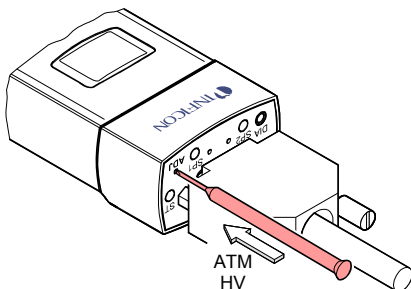

- 4 Evacuate the vacuum system to $p \ll 10^{-5}$ mbar and wait at least 2 minutes.
- 5 Press the <ADJ> button with a pin and the HV adjustment is carried out: The gauge is adjusted to 5×10^{-5} mbar (default).



HV adjustment to another pressure →  [3].

- ✓ If the pressure value 4.99×10^{-5} mbar is output at the measurement value output or on the LCD display, the adjustment has been successful. Otherwise, repeat the adjustment procedure.

6.2 Replacing the Sensor

In case of severe contamination or a malfunction, the sensor can be replaced.

Precondition

Gauge deinstalled (→  49).

- 1 Unscrew the hexagon socket screws and remove the sensor without twisting it.

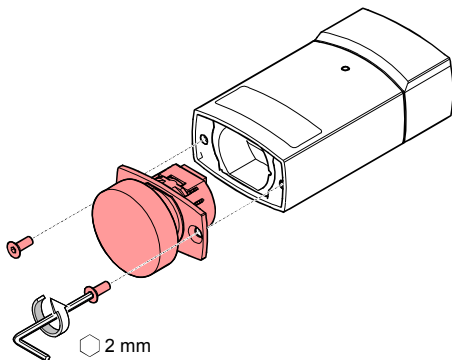



- 2 Place the new sensor without twisting it and lock it with the screws.

6.3 Troubleshooting



In case of an error, it may be helpful to just turn off the mains supply and turn it on again after 5 s.

Problem	Possible cause	Correction
Output signal permanently =0V	Sensor cable defective or not correctly connected	Check the sensor cable
	No supply voltage	Turn on the power supply
	Error	Remedy the error
	Gauge in an undefined status	Turn the gauge off and on again after 5 s (reset)
FAIL PIR1	Pirani sensor defective	Replace the sensor (→  53)
	Electronics unit not correctly mounted on sensor	Check the connections (electronics – sensor)
FAIL EEPROM	EEPROM error	Turn the gauge off and on again after 5 s (reset)
		Replace the gauge
FAIL SENSOR	Electronics unit not compatible with the sensor	Replace the sensor (→  53)
		Replace the gauge

7 Returning the Product



WARNING



WARNING: forwarding contaminated products
Contaminated products (e.g. radioactive, toxic, caustic or microbiological hazard) can be detrimental to health and environment.

Products returned to INFICON should preferably be free of harmful substances. Adhere to the forwarding regulations of all involved countries and forwarding companies and enclose a duly completed declaration of contamination^{*)}.

^{*)} Form under www.inficon.com

Products that are not clearly declared as "free of harmful substances" are decontaminated at the expense of the customer.

Products not accompanied by a duly completed declaration of contamination are returned to the sender at his own expense.

8 Disposal



DANGER



DANGER: contaminated parts

Contaminated parts can be detrimental to health and environment.

Before beginning to work, find out whether any parts are contaminated. Adhere to the relevant regulations and take the necessary precautions when handling contaminated parts.



WARNING



WARNING: substances detrimental to the environment

Products or parts thereof (mechanical and electric components, operating fluids etc.) can be detrimental to the environment.

Dispose of such substances in accordance with the relevant local regulations.

Separating the components

After disassembling the product, separate its components according to the following criteria:

- Contaminated components

Contaminated components (radioactive, toxic, caustic or biological hazard etc.) must be decontaminated in accordance with the relevant national regulations, separated according to their materials, and disposed of.

- Other components

Such components must be separated according to their materials and recycled.

9 Accessories

	Ordering No.
Centering ring with fine filter DN 16 ISO-KF	211-097
Communication adapter (2 m) ⁶⁾	303-333

⁶⁾ The diagnostic software (Windows NT, XP) can be downloaded from our website.

10 Spare Parts

When ordering spare parts, always indicate:







- all information on the product nameplate
- description and ordering number



Sensor for gauge with tungsten (W) filament		Ordering No.	
PCG550	3PI1-0x1-xxxx	DN 16 ISO-KF	355-925
	3PI6-0x1-xxxx		
	3PI1-0x2-xxxx	DN 16 ISO-KF, long tube	355-926
	3PI6-0x2-xxxx		
	3PI1-0x4-xxxx	DN 16 CF-F	355-927
	3PI6-0x4-xxxx		
	3PI1-0x5-xxxx	DN 16 CF-R, long tube	355-928
	3PI6-0x5-xxxx		
	3PI1-0x6-xxxx	DN 25 ISO-KF	355-929
	3PI6-0x6-xxxx		
	3PI1-0xD-xxxx	4 VCR female	355-932
	3PI6-0xD-xxxx		
	3PI1-0xE-xxxx	8 VCR female	355-931
	3PI6-0xE-xxxx		
	3PI1-0xF-xxxx	1/8" NPT	355-930
	3PI6-0xF-xxxx		
	3PI1-0xK-xxxx	29×29 mm	355-934
	3PI6-0xK-xxxx		
	3PI1-0xM-xxxx	4 VCR 90° female	355-935
	3PI6-0xM-xxxx		
3PI1-0xN-xxxx	7/16-20 UNF male	355-933	
3PI6-0xN-xxxx			

Sensor for gauge with nickel (Ni) filament		Ordering No.	
PCG552	3PI2-0x1-xxxx	DN 16 ISO-KF	355-936
	3PI7-0x1-xxxx		
	3PI2-0x2-xxxx	DN 16 ISO-KF, long tube	355-937
	3PI7-0x2-xxxx		
	3PI2-0x4-xxxx	DN 16 CF-F	355-938
	3PI7-0x4-xxxx		
	3PI2-0x5-xxxx	DN 16 CF-R, long tube	355-939
	3PI7-0x5-xxxx		
	3PI2-0x6-xxxx	DN 25 ISO-KF	355-940
	3PI7-0x6-xxxx		
	3PI2-0xD-xxxx	4 VCR female	355-943
	3PI7-0xD-xxxx		
	3PI2-0xE-xxxx	8 VCR female	355-942
	3PI7-0xE-xxxx		
	3PI2-0xF-xxxx	1/8" NPT	355-941
	3PI7-0xF-xxxx		
	3PI2-0xK-xxxx	29×29 mm	355-945
	3PI7-0xK-xxxx		
	3PI2-0xM-xxxx	4 VCR 90° female	355-946
	3PI7-0xM-xxxx		
3PI2-0xN-xxxx	7/16-20 UNF male	355-944	
3PI7-0xN-xxxx			

Sensor for gauge with Al ₂ O ₃ coated filament		Ordering No.	
PCG554	3PI3-0x1-xxxx	DN 16 ISO-KF	355-947
	3PI8-0x1-xxxx		
	3PI3-0x2-xxxx	DN 16 ISO-KF, long tube	355-948
	3PI8-0x2-xxxx		
	3PI3-0x4-xxxx	DN 16 CF-F	355-949
	3PI8-0x4-xxxx		
	3PI3-0x5-xxxx	DN 16 CF-R long tube	355-950
	3PI8-0x5-xxxx		
	3PI3-0x6-xxxx	DN 25 ISO-KF	355-951
	3PI8-0x6-xxxx		
	3PI3-0xD-xxxx	4 VCR female	355-954
	3PI8-0xD-xxxx		
	3PI3-0xE-xxxx	8 VCR female	355-953
	3PI8-0xE-xxxx		
	3PI3-0xF-xxxx	1/8" NPT	355-952
	3PI8-0xF-xxxx		
	3PI3-0xK-xxxx	29×29 mm	355-956
	3PI8-0xK-xxxx		
	3PI3-0xM-xxxx	4 VCR 90° female	355-957
	3PI8-0xM-xxxx		
3PI3-0xN-xxxx	7/16-20 UNF male	355-955	
3PI8-0xN-xxxx			

Further Information

-  [1] www.inficon.com
 Operating Manual
 Single-Channel Controller VGC401
 tinb01d1 German
 tinb01e1 English
 INFICON AG, LI-9496 Balzers, Liechtenstein
-  [2] www.inficon.com
 Operating Manual
 Two and Three Channel Measurement and Control Unit
 VGC402, VGC403
 tinb07d1 German
 tinb07e1 English
 INFICON AG, LI-9496 Balzers, Liechtenstein
-  [3] www.inficon.com
 Communication Protocol
 Serial Interface RS232C, RS485C
 PCG55x, PSG55x
 tira59d1 German
 tira59e1 English
 INFICON AG, LI-9496 Balzers, Liechtenstein
-  [4] www.inficon.com
 Communication Protocol
 DeviceNet™ PCG55x, PSG55x
 tira58e1 English
 INFICON AG, LI-9496 Balzers, Liechtenstein
-  [5] www.inficon.com
 Communication Protocol
 Profibus PCG55x, PSG55x
 tira56e1 English
 INFICON AG, LI-9496 Balzers, Liechtenstein
-  [6] Common Industrial Protocol (CIP™) Ed. 3.5 and
 DeviceNet™ Adaption of CIP Ed. 1.6 (Open DeviceNet
 Vendor Association)
-  [7] www.odva.org
 Open DeviceNet Vendor Association, Inc. DeviceNet™
 Specifications

-  [8] IEC 61158 Type 3 elements: Industrial communication networks – Fieldbus specifications
 IEC 61784: Industrial communication networks – Fieldbus profiles
-  [9] www.profibus.com
 Profibus user organization

ETL Certification



ETL LISTED

The product PSG55x complies with the requirements of the following standards:
 ANSI/UL 61010-1, Issued: 2004/07/12
 Ed: 2 Rev: 2008/10/28
 CAN/CSA C22.2#61010-1,
 Issued: 2004/07/12 Ed: 2 (R2009)

EC Declaration of Conformity



We, INFICON, hereby declare that the equipment mentioned below complies with the provisions of the Directive relating to electromagnetic compatibility 2004/108/EC.

Pirani Standard Gauge

PSG550, PSG552, PSG554

Standards

Harmonized and international / national standards and specifications:

- EN 61000-6-2:2005 (EMC: generic immunity standard)
- EN 61000-6-3:2007 (EMC: generic emission standard)
- EN 61010-1:2001 (Safety requirements for electrical equipment for measurement, control and laboratory use)
- EN 61326-1:2006 (EMC requirements for electrical equipment for measurement, control and laboratory use)

Manufacturer / Signatures

INFICON AG, Alte Landstrasse 6, LI-9496 Balzers

10 December 2010

10 December 2010



Dr. Urs Wälchli
Managing Director

Claudio Christoffel
Product Manager

Original: German tina60d1-a (2011-04)



t1 na60e1-a



LI-9496 Balzers
Liechtenstein
Tel +423 / 388 3111
Fax +423 / 388 3700
reachus@inficon.com

www.inficon.com