

Capacitance Diaphragm Gauge

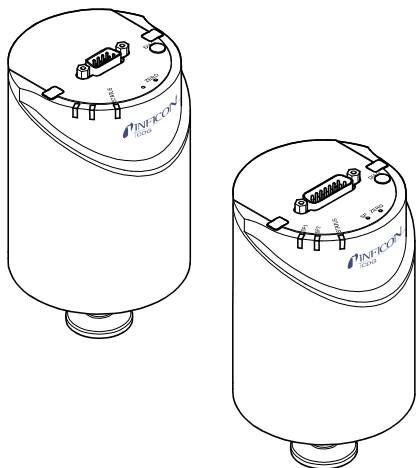



CDG100D



Operating Manual
Incl. EU Declaration of Conformity
Further languages under www.inficon.com

Product Identification

In all communications with INFICON, please specify the information given on the product nameplate. For convenient reference copy that information into the space provided below.

INFICON AG, LI-9496 Balzers		 
Model: _____	_____	
PN: _____	_____	 
SN: _____	_____ V _____ W; LPS 3103457	

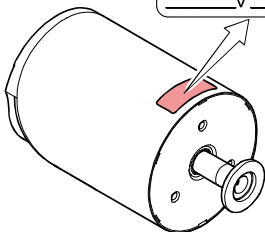

Validity

This document applies to products of the CDG100D series.

Part numbers of standard products are indicated below. OEM products have other part numbers and different parameter settings (e.g. factory setting of setpoint) as defined in the corresponding ordering information.

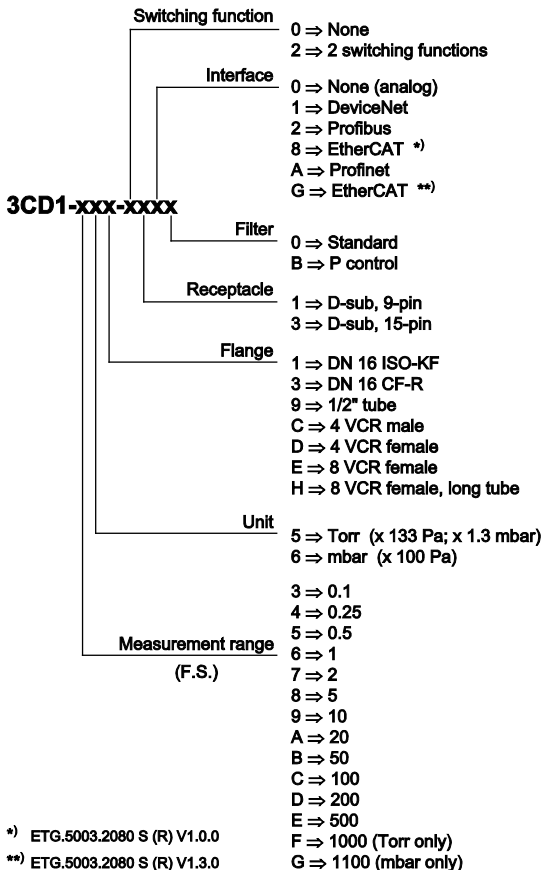

The part number (PN) can be taken from the product nameplate. If not indicated otherwise in the legends, the illustrations in this document correspond to gauges with D-Sub 15-pin connector and DN 16 ISO-KF vacuum connection. They apply to the other gauges by analogy.

We reserve the right to make technical changes without prior notice.

Intended Use

The temperature compensated Capacitance Diaphragm Gauges of the CDG100 series are intended for absolute pressure measurement of gases in their respective pressure ranges (→  2).

The gauges belong to the SKY[®] Smart Sensors family and can be operated in connection with an INFICON Vacuum Gauge Controller (VGC series) or another appropriate controller.

Functional Principle

A ceramic diaphragm is deflected by pressure. The deflection is measured capacitively and converted into an analog linear output signal by the digital electronics.

The output signal is independent of the gas type.

Very accurate pressure measurement is achieved by heating the sensor to a constant temperature of 100°C which results in a compensation of changes in the ambient conditions and a reduced deposition of process products and by-products in process applications. An integrated baffle protects the sensor against coating.

Trademarks

SKY[®] INFICON GmbH
VCR[®] Swagelok Marketing Co.

Patents

EP 1070239 B1, 1040333 B1

US Patents 6528008, 6591687, 7107855, 7140085



Scope of Delivery

- 1× gauge CDG100D
- 1× insulation shell
- 1× pin for adjusting settings via buttons
- 1× Calibration Test Report
- 1× Operating Manual German
- 1× Operating Manual English

Contents

Product Identification	2
Validity	2
Intended Use	4
Functional Principle	4
Trademarks	4
Patents	5
Scope of Delivery	5
1 Safety	8
1.1 Symbols Used	8
1.2 Personnel Qualifications	8
1.3 General Safety Instructions	9
1.4 Liability and Warranty	9
2 Technical Data	10
3 Installation	16
3.1 Vacuum Connection	16
3.2 Power Connection	20
3.2.1 D-sub, 9-pin Connector	21
3.2.2 D-sub, 15-pin Connector	22
4 Operation	23
4.1 Status Indication	23
4.2 Zeroing the Gauge	24
4.2.1 <ZERO> Adjustment	25
4.3 Switching Functions	29
4.4 Activating the Factory Setting (Factory Reset)	32
4.5 Diagnostic Port (RS232C Interface)	33
5 Deinstallation	34
5.1 Power Connection	34
5.2 Vacuum connection	34
6 Maintenance, Repair	37
7 Returning the Product	37
8 Disposal	38
9 Accessories	39

Further Information	39
ETL Certification	41
EU Declaration of Conformity	42

For cross-references within this document, the symbol (→  XY) is used, for cross-references to further documents, listed under "Further Information", the symbol (→  [Z]).

1 Safety

1.1 Symbols Used



DANGER

Information on preventing any kind of physical injury.



WARNING

Information on preventing extensive equipment and environmental damage.



Caution

Information on correct handling or use. Disregard can lead to malfunctions or minor equipment damage.



Notice

1.2 Personnel Qualifications



Skilled personnel

All work described in this document may only be carried out by persons who have suitable technical training and the necessary experience or who have been instructed by the end-user of the product.

1.3 General Safety Instructions

- Adhere to the applicable regulations and take the necessary precautions for the process media used.
Consider possible reactions with the product materials.
- Adhere to the applicable regulations and take the necessary precautions for all work you are going to do and consider the safety instructions in this document.
- Before beginning to work, find out whether any vacuum components are contaminated. Adhere to the relevant regulations and take the necessary precautions when handling contaminated parts.

Communicate the safety instructions to all other users.

1.4 Liability and Warranty

INFICON assumes no liability and the warranty becomes null and void if the end-user or third parties

- disregard the information in this document
- use the product in a non-conforming manner
- make any kind of interventions (modifications, alterations etc.) on the product
- use the product with accessories not listed in the product documentation.

The end-user assumes the responsibility in conjunction with the process media used.

Gauge failures due to contamination are not covered by the warranty.

2 Technical Data





For further technical data for gauges with DeviceNet, Profibus, EtherCAT or Profinet interface →  [6], [7], [8], [9] and [10].

Measurement range	→ "Validity"
Accuracy ¹⁾	
≤0.5 Torr/mbar F.S.	0.4% of reading
≥1 Torr/mbar F.S.	0.2% of reading
Temperature effect on zero	
≤0.5 Torr/mbar F.S.	0.0050% F.S./ °C
≥1 Torr/mbar F.S.	0.0025% F.S./ °C
Temperature effect on span	0.02% of reading / °C
Resolution	0.003% F.S.
Gas type dependence	none
<hr/>	
Output signal analog (measurement signal)	
Measurement range	0 ... +10 V
Voltage range	-5 ... +10.24 V (limited to +10.24 V)
Relationship voltage-pressure	linear
Output impedance	0 Ω (short-circuit proof)
Loaded impedance	>10 kΩ
Response time ²⁾	
≥0.25 Torr/mbar (F.S.)	30 ms
0.1 Torr/mbar (F.S.)	130 ms

¹⁾ Non-linearity, hysteresis, repeatability in the calibrated range at 25 °C ambient operating temperature without temperature effects after operation of 2 h.

²⁾ Increase 10 ... 90 % F.S.R.

Identification	
Resistance R_{Ident}	13.2 k Ω referenced to supply common
Voltage	≤ 5 V
Remote Zero Adjust	digital input for zero adjustment with external switching contact (\rightarrow  25)
External switching contact	30 V (dc) / ≤ 5 mA (dc)
Pulse	> 1 s ... < 5 s
Switching functions	SP1, SP2
Setting range	0 ... 99% F.S. (0 ... 9.9 V)
Hysteresis	1% F.S.
Relay contact	30 V (dc) / ≤ 0.5 A (dc)
	floating (NO)
closed	$p \leq p_{\text{SP}}$ (LED lit solid)
open	$p \geq p_{\text{SP}}$ (LED off)
Switching time	≤ 50 ms
Status relay	
Relay contact	30 V (dc) / ≤ 0.5 A (dc)
	connected to supply common (pin 5)
closed	measurement mode warning
open	no supply voltage warning up error
RS232C interface	
Transmission rate	9600 baud
Data format	binary
	8 data bits
	one stop bit
	no parity bit
	no handshake
	\rightarrow "Power Connection"
For further information on the RS232C interface \rightarrow  [5].	

Diagnostic port

Jack connector, 2.5 mm,
3-pin

Supply



DANGER



The gauge may only be connected to power supplies, instruments or control devices that conform to the requirements of a grounded protective extra-low voltage (PELV) and limited power source (LPS), Class 2. The connection to the gauge has to be fused ³⁾.

Supply voltage at the gauge	Class 2 / LPS +14 ... +30 V (dc) or ±15 V (±5%)
-----------------------------	---

Ripple	≤1 V _{pp}
--------	--------------------

Power consumption without fieldbus	
while being heated	≤15 W
at operating temperature	≤10 W
with fieldbus	
while being heated	≤16.5 W
at operating temperature	≤11.5 W

Fuse to be connected ³⁾	1.6 AT
------------------------------------	--------

The gauge is protected against reverse polarity of the supply voltage and overload.

Electrical connection	
3CD1-xxx-0xxx	9-pin D-sub, male
3CD1-xxx-2xxx	15-pin D-sub, male

Sensor cable for	
3CD1-xxx-0xxx	9-pin plus shielding
3CD1-xxx-2xxx	15-pin plus shielding

³⁾ INFICON controllers fulfill this requirement.

Cable length	
Supply voltage 15 V	≤ 4 m (0.14 mm ² /conductor) ≤ 7 m (0.25 mm ² /conductor)
Supply voltage 24 V	≤20 m (0.14 mm ² /conductor) ≤35 m (0.25 mm ² /conductor)
Supply voltage 30 V	≤40 m (0.14 mm ² /conductor) ≤70 m (0.25 mm ² /conductor)

For longer cables, larger conductor cross-sections are required ($R_{\text{cable}} \leq 1.0 \Omega$).

Grounding concept	→ "Power Connection"
Materials exposed to vacuum	ceramics ($\text{Al}_2\text{O}_3 \geq 99.5\%$), stainless steel AISI 316L
Internal volume	≤4.2 cm ³
Admissible pressure (absolute)	
200 / 500 / 1000 / 1100 F.S.	4 bar 400 kPa
1 / 2 / 5 / 10 / 20 / 50 / 100 F.S.	2.6 bar 260 kPa
0.1 / 0.25 / 0.5 F.S.	1.3 bar 130 kPa
Bursting pressure (absolute)	6 bar 600 kPa

Admissible temperatures	
Storage	−40 °C ... +65 °C
Operation	+10 °C ... +50 °C
Bakeout	≤110 °C at the flange
Relative humidity	≤80% at temperatures ≤+31 °C, decreasing to 50% at +40°C
Use	indoors only, altitude up to 2000 m NN
Degree of protection	IP 40

Dimensions [mm]

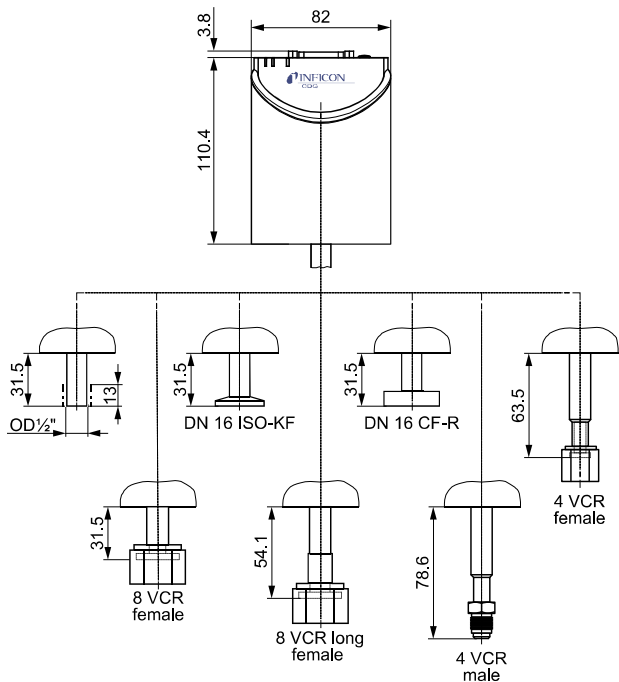

Weight

837 ... 897 g

Analog Measurement Signal vs. Pressure

Pressure p

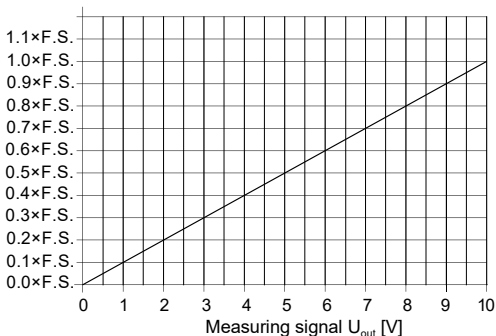

$$p = (U_{out} / 10 \text{ V}) \times p (\text{F.S.})$$

Conversion Torr \leftrightarrow Pascal

	Torr	mbar ⁴⁾	Pa ⁴⁾
c	1.00	1013.25 / 760 = 1.3332...	101325 / 760 = 133.3224...

Example: Gauge with 10 Torr F.S.

Measurement signal $U_{out} = 6 \text{ V}$

$$\begin{aligned} p &= (6 \text{ V} / 10 \text{ V}) \times 10 \text{ Torr} \\ &= 0.6 \times 10 \text{ Torr} = \mathbf{6 \text{ Torr}} \end{aligned}$$

⁴⁾ Source: NPL (National Physical Laboratory)
Guide to the Measurement of Pressure and Vacuum, ISBN 0904457x / 1998

3 Installation



WARNING



Fragile components

The ceramic sensor may be damaged by impacts. Do not drop the product and prevent shocks and impacts.

3.1 Vacuum Connection



DANGER



Overpressure in the vacuum system >1 bar

Injury caused by released parts and harm caused by escaping process gases can result if clamps are opened while the vacuum system is pressurized.

Do not open any clamps while the vacuum system is pressurized. Use the type clamps which are suited to overpressure.



DANGER



Overpressure in the vacuum system >2.5 bar

KF flange connections with elastomer seals (e.g. O-rings) cannot withstand such pressures. Process media can thus leak and possibly damage your health.

Use O-rings provided with an outer centering ring.

DANGER

Protective ground

Products that are not correctly connected to ground can be extremely hazardous in the event of a fault.

Electrically connect the gauge to the grounded vacuum chamber. This connection must conform to the requirements of a protective connection according to EN 61010:

- CF and VCR flanges fulfill this requirement.
- For gauges with a KF flange, use a conductive metallic clamping ring.
- For gauges with a 1/2" tube, take appropriate measures to fulfill this requirement.

Caution

Vacuum component

Dirt and damages impair the function of the vacuum component.

When handling vacuum components, take appropriate measures to ensure cleanliness and prevent damages.

Caution

Dirt sensitive area

Touching the product or parts thereof with bare hands increases the desorption rate.

Always wear clean, lint-free gloves and use clean tools when working in this area.



Mount the gauge so that no vibrations occur. The gauge may be mounted in any orientation. To keep condensates and particles from getting into the measuring chamber preferably choose a horizontal to upright position. If adjustment should be possible after the gauge has been installed, be sure to install it so that the buttons can be accessed with a pin (→ 24).

1

Remove the protective lid and connect the product to the vacuum system.

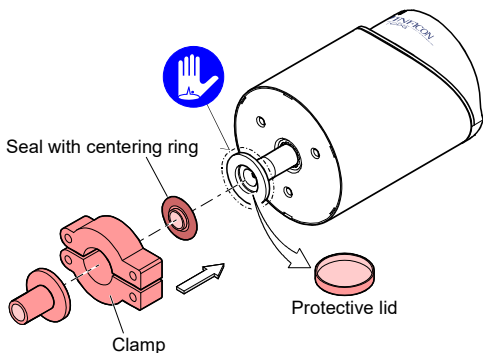

Keep the protective lid.

- 2** Mount the insulation shell.

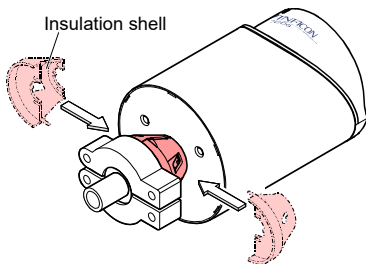

3.2 Power Connection



Make sure the vacuum connection is properly made (→ 16).



DANGER

The gauge may only be connected to power supplies, instruments or control devices that conform to the requirements of a grounded protective extra-low voltage (PELV) and limited power source (LPS), Class 2. The connection to the gauge has to be fused ⁵⁾.



Ground loops, differences of potential, or EMC problems may affect the measurement signal. For optimum signal quality, please do observe the following notes:

- Use an overall metal braided shielded cable. The connector must have a metal case.
- Connect the cable shield to ground at one side via the connector case. Make sure the connector case has direct contact to the cable's shield on its whole circumference. Do not connect the other side of the shield.
- Connect the supply common with protective ground directly at the power.
- Use differential measurement input (signal common and supply common conducted separately).
- Potential difference between supply common and housing ≤ 18 V (overvoltage protection).

⁵⁾ INFICON controllers fulfill this requirement.

3.2.1 D-sub, 9-pin Connector

If no sensor cable is available, make one according to the following diagram (cable length and conductor cross-sections → 13).

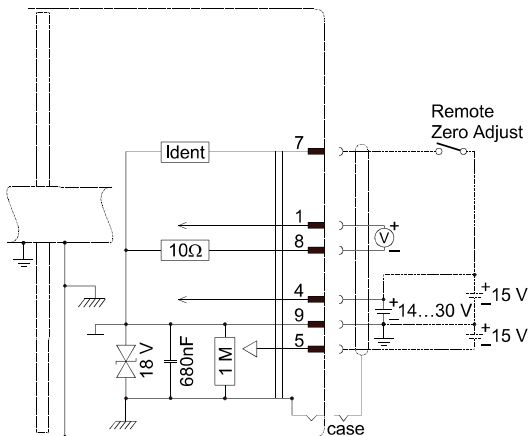

Electrical connection

- Pin 1 Signal output (measurement signal)
- Pin 2 n.c.
- Pin 3 n.c.
- Pin 4 Supply (+14 ... +30 V or +15 V)
- Pin 5 Supply (-15 V)
- Pin 6 n.c.
- Pin 7 Gauge identification or Remote Zero Adjust
- Pin 8 Signal common
- Pin 9 Supply common
- case Connector case

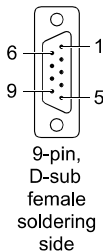

3.2.2 D-sub, 15-pin Connector

If no sensor cable is available, make one according to the following diagram (cable length and conductor cross-sections → 13).

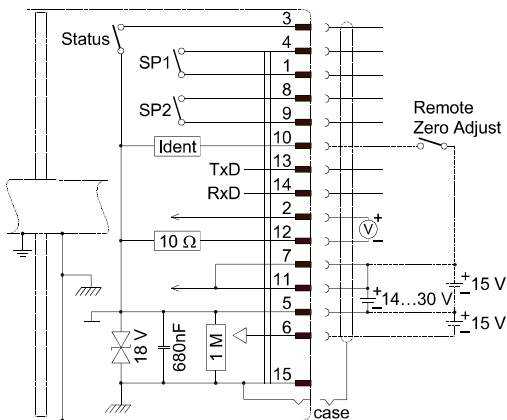

Electrical connection

Pin 1, 4	Relay SP1, closing contact
Pin 2	Signal output (measurement signal) or thresholds SP1/2
Pin 3	Status
Pin 5	Supply common
Pin 6	Supply (-15 V)
Pin 7, 11	Supply (+14 ... +30 V or +15 V)
Pin 8, 9	Relay SP2, closing contact
Pin 10	Gauge identification or Remote Zero Adjust
Pin 12	Signal common
Pin 13	RS232, TxD
Pin 14	RS232, RxD
Pin 15	Housing (Chassis Ground)
case	Connector case

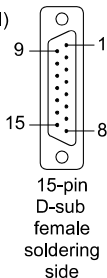

4 Operation

Put the gauge into operation. If you are using an INFICON controller (VGC series), define the measurement range (→  [1], [2], [3], [4]).

A warm-up time of at least 90 minutes should be allowed; for precise pressure measurements a warm-up time of at least 3 hours is required.



If the gauge is used for fast downstream pressure control we recommend setting its signal filter to "fast".

The filter can be set via the RS232C interface or the diagnostic port (→  [5]).

4.1 Status Indication

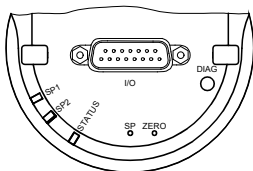

LED	LED status	Meaning
<STATUS>	off	no supply voltage
	lit solid green	measurement mode
	blinking green	warning, over/underrange warming up
	short blinks	
	long blinks	
lit solid red	error	
<SP1>	lit green	$p \leq$ setpoint 1
	blinking green	waiting for setpoint 1 input
	off	$p >$ setpoint 1
<SP2>	lit solid green	$p \leq$ setpoint 2
	blinking green	waiting for setpoint 2 input
	off	$p >$ setpoint 2

4.2 Zeroing the Gauge

The gauge is factory calibrated while "standing upright" (→ "Calibration Test Report").



We recommend performing a zero adjustment, when the gauge is operated for the first time.

Due to long time operation or contamination, a zero drift could occur and zero adjustment may become necessary.

For adjusting the zero, operate the gauge under the same constant ambient conditions and in the same mounting orientation as normally.

The output signal (measuring signal) is depending on the mounting orientation. The signal difference between the vertical and horizontal mounting orientation is:

F.S.	$\Delta U / 90^\circ$
1000 Torr/mbar	$\approx 2 \text{ mV}$
100 Torr/mbar	$\approx 10 \text{ mV}$
10 Torr/mbar	$\approx 50 \text{ mV}$
1 Torr/mbar	$\approx 300 \text{ mV}$
0.1 Torr/mbar	$\approx 1.8 \text{ V}$





If the gauge is operated via a controller, the zero of the whole measuring system has to be adjusted on the controller: first, adjust the zero of the gauge and then, the zero of the controller.

4.2.1 <ZERO> Adjustment



The zero can be adjusted via

- the <ZERO> button on the gauge,
- the diagnostic port (→  [5]),
- the digital input "Remote Zero": Apply the supply voltage to pin 10 (15-pin) or to pin 7 (9-pin), pulse →  11,
- the RS232C interface (→  [5]),
- an INFICON Vacuum Gauge Controller (VGC series).



While the gauge is being heated and/or under atmospheric pressure, the zeroing function is locked in order for operating errors to be prevented.





Evacuate the gauge to a pressure according to the table below:

F.S.		Recommended final pressure for zero adjustment		
1100	mbar	–	$<6.65 \times 10^0$ Pa	$<6.65 \times 10^{-2}$ mbar
1000	Torr/mbar	$<5 \times 10^{-2}$ Torr	$<6.65 \times 10^0$ Pa	$<6.65 \times 10^{-2}$ mbar
500	Torr/mbar	$<2.5 \times 10^{-2}$ Torr	$<3.33 \times 10^0$ Pa	$<3.33 \times 10^{-2}$ mbar
200	Torr/mbar	$<10^{-2}$ Torr	$<1.33 \times 10^0$ Pa	$<1.33 \times 10^{-2}$ mbar
100	Torr/mbar	$<5 \times 10^{-3}$ Torr	$<6.65 \times 10^{-1}$ Pa	$<6.65 \times 10^{-3}$ mbar
50	Torr/mbar	$<2.5 \times 10^{-3}$ Torr	$<3.33 \times 10^{-1}$ Pa	$<3.33 \times 10^{-3}$ mbar
20	Torr/mbar	$<10^{-3}$ Torr	$<1.33 \times 10^{-1}$ Pa	$<1.33 \times 10^{-3}$ mbar
10	Torr/mbar	$<5 \times 10^{-4}$ Torr	$<6.65 \times 10^{-2}$ Pa	$<6.65 \times 10^{-4}$ mbar
5	Torr/mbar	$<2.5 \times 10^{-4}$ Torr	$<3.33 \times 10^{-2}$ Pa	$<3.33 \times 10^{-4}$ mbar
2	Torr/mbar	$<10^{-4}$ Torr	$<1.33 \times 10^{-2}$ Pa	$<1.33 \times 10^{-4}$ mbar
1	Torr/mbar	$<5 \times 10^{-5}$ Torr	$<6.65 \times 10^{-3}$ Pa	$<6.65 \times 10^{-5}$ mbar
0.5	Torr/mbar	$<2.5 \times 10^{-5}$ Torr	$<3.33 \times 10^{-3}$ Pa	$<3.33 \times 10^{-5}$ mbar
0.25	Torr/mbar	$<10^{-5}$ Torr	$<1.33 \times 10^{-3}$ Pa	$<1.33 \times 10^{-5}$ mbar
0.1	Torr/mbar	$<5 \times 10^{-6}$ Torr	$<6.65 \times 10^{-4}$ Pa	$<6.65 \times 10^{-6}$ mbar

If the final pressure is too high for zero adjustment ($>25\%$ of the F.S.), the zero cannot be reached and the <STATUS> LED blinks green. If this is the case, activate the factory setting and adjust the zero again (→  32).

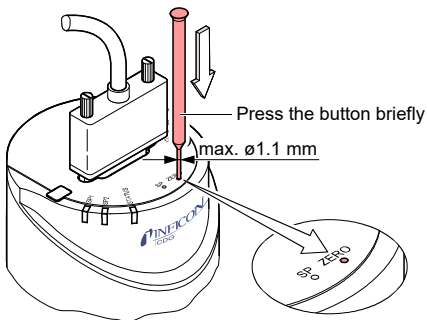
- 2 Operate the gauge for at least 90 minutes under constant ambient conditions (until the signal is stable).
- 3 Briefly press the <ZERO> button with a pin (max. $\varnothing 1.1$ mm). The zero adjustment runs automatically. The <STATUS> LED blinks until the adjustment (duration ≤ 8 s) is completed.



 After zero adjustment, the gauge automatically returns to the measurement mode.

The <STATUS> LED blinks green if

- the signal output is negative (< -20 mV) when the final pressure has been attained
- the zero adjustment has failed.

4.2.2 <ZERO> Adjustment with Ramp Function

The ramp function allows to adjust the zero at a known reference pressure within the measurement range of the gauge.



It also permits to adjust an offset of the characteristic curve in order to

- compensate for the offset of the measuring system or
- obtain a slightly positive zero for a 0 ... 10 V AD converter.

The offset should not exceed 2% of the F.S. (+200 mV). At a higher positive offset, the upper limit of the measurement range is exceeded.



Zero adjustment using the ramp function can be performed via

- the <ZERO> button on the gauge,
- the diagnostic port (→  [5]),
- the RS232C interface (→  [5]).



Recommended procedure for adjusting the offset of a measuring system: → Notice  24.

1

Operate the gauge for at least 90 minutes under constant ambient conditions (until the signal is stable).

2

Push the <ZERO> button with a pin (max. $\varnothing 1.1$ mm) and keep it depressed. The <STATUS> LED starts blinking. After 5 s, the zero adjustment value, starting at the current output value, keeps continually changing (ramp) until the button is released or until the setting limit (max. 25% F.S.) is reached. The corresponding output signal is delayed by about 1 s.

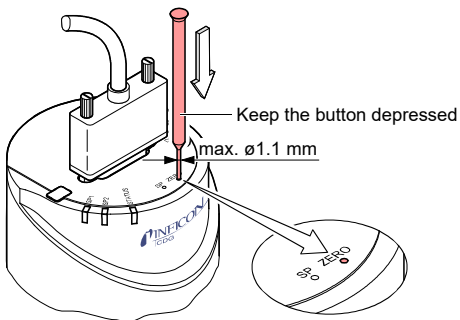

3 Push the <ZERO> button again:

Fine adjustment
within 0...3 s:

the zero adjustment value changes
by one unit (push <ZERO> button in
intervals of 1 s)

Change of direction
within 3...5 s:

the zero adjustment changes its
direction (the blinking frequency of
the <STATUS> LED changes
briefly)



If the <ZERO> button is released for more than 5 s, the gauge returns to the measurement mode.

The <STATUS> LED blinks green if the signal output is negative (< -20 mV).

4.3 Switching Functions

The two switching functions can be set to any pressure within the measurement range of the gauge (→ [15](#)).

The current setpoint setting

- can be read/written via the diagnostic port,
- is output at the D-Sub connector instead of the measurement signal (→ [22](#)) and can be measured with a voltmeter after the <SP> button is pressed, or
- can be read/written via the RS232C interface.

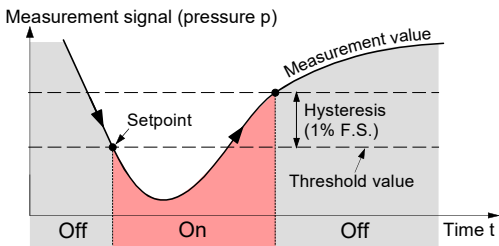

If the pressure is lower than the setpoint, the corresponding LED (<SP1> or <SP2>) is lit solid and the corresponding relay (→ [22](#)) is energized.



4.3.1 Adjusting the Setpoints



The setpoints can be adjusted via

- the buttons on the gauge,
- the diagnostic port (→  [5]),
- the RS232C interface (→  [5]).



DANGER



Malfunction

If processes are controlled via the signal output, keep in mind that by pushing the <SP> button the measurement signal is suppressed and the corresponding threshold value is output instead. This can cause malfunctions.

Push the <SP> button only if you are sure that no malfunction cause.

Adjusting Setpoint <1>



Push the <SP> button with a pin (max. $\varnothing 1.1$ mm). The gauge changes to the switching function mode and outputs the current threshold value at the measurement value output for about 10 s (LED <1> blinks).

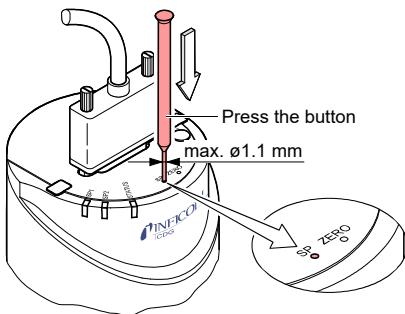

- 2** For changing the threshold value, push the <ZERO> button and keep it depressed. The threshold keeps changing from the current value (ramp) until the button is released or until the limit of the setting range is reached.

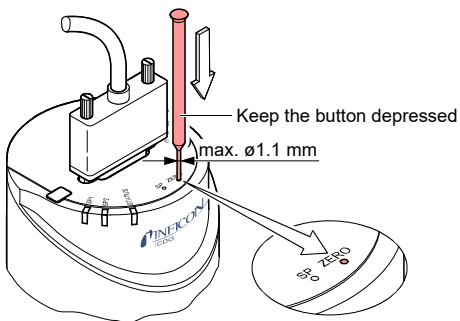

- 3** Push the <ZERO> button again:

Fine adjustment within 0...3 s:	the zero adjustment value changes by one unit
Change of direction within 3...5 s:	the zero adjustment changes its direction (the blinking frequency of the <STATUS> LED changes briefly)



If the <ZERO> button is released for more than 5 s, the gauge returns the measurement mode.



The upper threshold is automatically set 1% F.S. above the lower one (hysteresis).

Adjusting Setpoint <2>

Push the <SP> button twice (the LED <2> blinks). The adjustment procedure is the same as for setpoint <1>.

4.4 Activating the Factory Setting (Factory Reset)

All user defined parameters (e.g. zero, filter) are restored to their default values.



Loading of the default parameters is irreversible.

Loading the default parameters:

- 1** Put the gauge out of operation.
- 2** Keep the <ZERO> button depressed for at least 5 s while the gauge is being put into operation (Power ON).

4.5 Diagnostic Port (RS232C Interface)

The diagnostic port <DIAG> permits to output the pressure reading and all status information and to enter all settings at the same time (→  [5]).

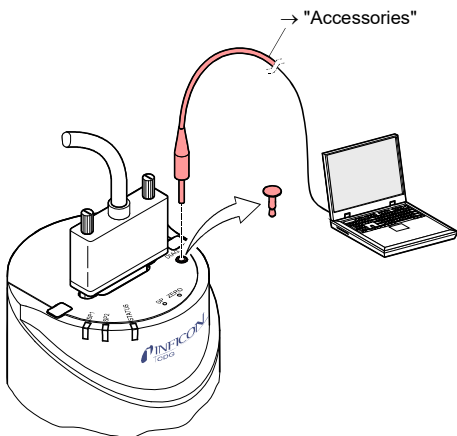

5 Deinstallation

Preconditions:

- Vacuum system vented
- Vacuum system cooled to <math>< 50\text{ }^\circ\text{C}</math>

5.1 Power Connection

- 1 Put the gauge out of operation.
- 2 Unfasten the lock screws and disconnect the sensor cable.

5.2 Vacuum connection



DANGER



Hot surface

Touching the hot surface (>50 °C) can cause burns.

Put the product out of operation and allow it to cool down.

WARNING



Fragile components

The ceramic sensor may be damaged by impacts.

Do not drop the product and prevent shocks and impacts.

DANGER

Contaminated parts

Contaminated parts can be detrimental to health and environment.

Before beginning to work, find out whether any parts are contaminated. Adhere to the relevant regulations and take the necessary precautions when handling contaminated parts.

Caution

Vacuum component

Dirt and damages impair the function of the vacuum component.

When handling vacuum components, take appropriate measures to ensure cleanliness and prevent damages.



Caution

Dirt sensitive area

Touching the product or parts thereof with bare hands increases the desorption rate.

Always wear clean, lint-free gloves and use clean tools when working in this area.

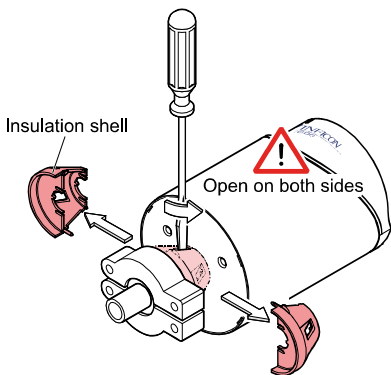
- 1 Remove the insulation shell.



- 2 Remove the gauge from the vacuum system and install the protective lid.

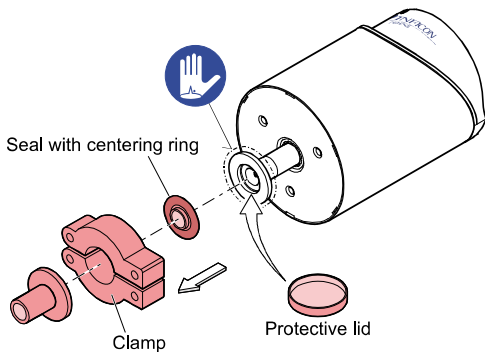

6 Maintenance, Repair

Under clean operating conditions, the product requires no maintenance.



Gauge failures due to contamination are not covered by the warranty.

We recommend checking the zero at regular intervals (→  25).

INFICON assumes no liability and the warranty becomes null and void if any repair work is carried out by the end-user or third parties.

7 Returning the Product



WARNING



Forwarding contaminated products

Contaminated products (e.g. radioactive, toxic, caustic or microbiological hazard) can be detrimental to health and environment.

Products returned to INFICON should preferably be free of harmful substances. Adhere to the forwarding regulations of all involved countries and forwarding companies and enclose a duly completed declaration of contamination^{*)}.

^{*)} Form under www.inficon.com

Products that are not clearly declared as "free of harmful substances" are decontaminated at the expense of the customer.

Products not accompanied by a duly completed declaration of contamination are returned to the sender at his own expense.

8 Disposal



DANGER



Contaminated parts

Contaminated parts can be detrimental to health and environment.

Before beginning to work, find out whether any parts are contaminated. Adhere to the relevant regulations and take the necessary precautions when handling contaminated parts.



WARNING



Substances detrimental to the environment

Products or parts thereof (mechanical and electric components, operating fluids etc.) can be detrimental to the environment.

Dispose of such substances in accordance with the relevant local regulations.

Separating the components

After disassembling the product, separate its components according to the following criteria:

- Contaminated components





Contaminated components (radioactive, toxic, caustic or biological hazard etc.) must be decontaminated in accordance with the relevant national regulations, separated according to their materials, and disposed of.
- Other components

Such components must be separated according to their materials and recycled.

9 Accessories

	Ordering number
Communication adapter (2 m) ⁶⁾	303-333

Further Information

-  [1] Operating Manual
 Vacuum Gauge Controller VGC032
 tinb02e1
 INFICON AG, LI-9496 Balzers, Liechtenstein
-  [2] Operating Manual
 Single-Channel Controller VGC401
 tinb01e1
 INFICON AG, LI-9496 Balzers, Liechtenstein
-  [3] Operating Manual
 Two- & Three-Channel Measurement and Control Unit
 VGC402, VGC403
 tinb07e1
 INFICON AG, LI-9496 Balzers, Liechtenstein
-  [4] Operating Manual
 One-, Two- & Three-Channel Measurement and Control
 Unit VGC501, VGC502, VGC503
 tina96e1
 INFICON AG, LI-9496 Balzers, Liechtenstein
-  [5] Communication Protocol
 RS232C Interface
 tira49e1
 INFICON AG, LI-9496 Balzers, Liechtenstein

⁶⁾ The diagnostic software (Windows NT, XP) can be downloaded from our website.

- [6] Communication Protocol
DeviceNet™ CDG100D
tira51e1
INFICON AG, LI-9496 Balzers, Liechtenstein
- [7] Communication Protocol
Profibus CDG100D
tira54e1
INFICON AG, LI-9496 Balzers, Liechtenstein
- [8] Communication Protocol
EtherCAT CDG100D (ETG.5003.2080 S (R) V1.0.0)
tira68e1
INFICON AG, LI-9496 Balzers, Liechtenstein
- [9] Communication Protocol
EtherCAT CDG100D (ETG.5003.2080 S (R) V1.3.0)
tirb45e1
INFICON AG, LI-9496 Balzers, Liechtenstein
- [10] Communication protocol
Profinet CDG100D
tirb62e1
INFICON AG, LI-9496 Balzers, Liechtenstein

ETL Certification

RECOGNIZED
COMPONENT



Intertek
3103457

ETL LISTED

The product CDG100D

- conforms to the UL Standard UL 61010-1
- is certified to the CAN/CSA Standard C22.2 No. 61010-1-12

EU Declaration of Conformity



We, INFICON, hereby declare that the equipment mentioned below complies with the provisions of the Directive relating to electromagnetic compatibility 2014/30/EU and the Directive on the restriction of the use of certain hazardous substances in electrical and electronic equipment 2011/65/EU.

Product

Capacitance Diaphragm Gauge
CDG100D

Standards

Harmonized and international/national standards and specifications:

- EN 61000-6-2:2005 (EMC: generic immunity standard)
- EN 61000-6-3:2007 + A1:2011 (EMC: generic emission standard)
- EN 61010-1:2010 (Safety requirements for electrical equipment for measurement, control and laboratory use)
- EN 61326-1:2013; Group 1, Class B (EMC requirements for electrical equipment for measurement, control and laboratory use)

Manufacturer / Signatures

INFICON AG, Alte Landstraße 6, LI-9496 Balzers

3 January 2017

3 January 2017



Dr. Bernhard Andraeus
Director Product Evolution

Alex Nef
Product Manager

Notes

Original: German tina52d1-g (2020-04)



tina52e1-q



LI-9496 Balzers
Liechtenstein
Tel +423 / 388 3111
Fax +423 / 388 3700
reachus@inficon.com

www.inficon.com