

TECHNICAL HANDBOOK

kina22e1-p (1206) Translation of the original instruction

Catalog No.

530-001
530-002
530-103
530-104
530-105
530-106



from software version V 2.4

Ecotec E3000

Multi-Gas Leak Detector

Content

1	General Information	1-1
1.1	Introduction	1-1
1.1.1	Intended Use	1-1
1.2	Support by INFICON	1-2
1.2.1	Service Centers	1-5
1.3	Unpacking	1-7
1.3.1	Supplied Equipment	1-7
1.3.2	Technical Data	1-8
1.3.3	Accessories	1-9
1.4	Notes on How to Use This Handbook	1-11
1.4.1	Numbering of Figures	1-11
1.4.2	Symbols of Vacuum Technology	1-11
1.4.3	Definition of Terms	1-11
1.5	Instrument Views of the Ecotec E3000	1-13
1.6	Installation	1-13
1.6.1	Set up	1-13
1.6.2	Mechanical Connections	1-15
1.6.3	Electrical Connections	1-18
1.6.4	RS232 Interface	1-19
1.6.5	I/O Port	1-19
2	How the Instrument Works	2-1
2.1	Description of the Functions	2-1
2.2	Description of the Subassemblies	2-2
2.2.1	Backing Pump	2-2
2.2.2	Turbo Molecular Pump (TMP)	2-2
2.2.3	Mass Spectrometer	2-2
2.2.4	Quadrupole Supply	2-2
2.2.5	Control	2-2
2.3	Displays and User Interfaces	2-3
2.3.1	Main unit display	2-3
2.3.2	Sniffer line with probe display	2-4
2.3.3	Built-in ECO-Check reference leak	2-6
3	Operation of the Ecotec E3000	3-1
3.1	Start-Up	3-1
3.2	Controls on the main display unit	3-2
3.3	Controls on the probe display unit	3-5
3.4	Performing measurements	3-6
3.4.1	Standard Operation Mode	3-6
3.4.2	I•Guide Operating Mode	3-8
3.4.2.1	Starting the I•Guide Mode	3-8
3.4.2.2	Selecting an I•Guide Program	3-9
3.4.2.3	Using an I•Guide Program	3-9
3.4.3	The Info Page	3-12
3.5	Calibration and Self-Test	3-14

3.5.1	Verifying a calibration (proof function)	3-15
3.5.2	Internal calibration	3-16
3.5.3	External calibration	3-17
3.6	Shutdown	3-19
<hr/>		
4	Equipment Settings	4-1
4.1	Menu Structure	4-1
4.2	Sleep Mode	4-3
4.3	The Service Menu	4-3
4.4	Selecting gases and setting gas triggers	4-3
4.4.1	Editing gas parameters	4-4
4.4.2	Removing / adding a working gas	4-4
4.4.3	Selecting trigger values and units of measurement	4-7
4.4.4	Selecting the search level and the lower display limit	4-8
4.4.5	Enabling / disabling internal calibration	4-8
4.4.6	Selecting an alternative mass position	4-9
4.4.7	Activating the Interfering Gas Suppression (IGS)	4-10
4.4.8	Setting up a user-definable gas	4-10
4.5	Settings Sub-menu	4-12
4.5.1	Vacuum & Access Menu	4-12
4.5.2	Audio Functions	4-14
4.5.3	Display Settings	4-16
4.5.4	Setting-up / editing an I•Guide Program	4-18
4.5.5	Miscellaneous Settings	4-21
4.6	Interfaces	4-23
4.6.1	Control location	4-23
4.6.2	Recorder outputs	4-23
4.6.3	RS232 Protocol	4-26
4.6.4	Baud rate & end sign	4-27
4.6.5	Select PLC Inputs	4-27
4.6.6	Select PLC Outputs	4-28
4.6.7	ECO-Check (only available in Advanced Mode)	4-29
4.7	The Info Menu	4-30
4.8	History & Maintenance	4-34
4.9	Monitoring Sensitivity	4-39
<hr/>		
5	Ecotec E3000 Messages	6-1
5.1	Error Messages and Warnings	6-1
<hr/>		
6	Detecting Specific Gases	5-1
6.1	R134a / Cyclopentane	5-1
6.2	R134a / R245fa	5-1
6.3	R600a / Cyclopentane / Isopentane	5-1
6.4	Helium	5-1
6.5	Hydrogen / Forming gas	5-2
6.6	Methan	5-2

7	Equipment Connections	7-1
7.1	I/O Port (Control Inputs and Outputs)	7-1
7.1.1	Ground connectors	7-2
7.1.2	24V Output	7-2
7.1.3	PLC Inputs	7-2
7.1.4	PLC Outputs	7-3
7.1.4.1	Relay outputs	7-4
7.1.4.2	Recorder Outputs	7-5
7.1.5	How to perform a calibration	7-6
7.2	RS232 interface	7-7
<hr/>		
8	Maintenance	8-1
8.1	Maintenance schedule	8-1
8.2	Adjusting the IGS function	8-2
8.3	Exchanging the air filter	8-3
8.4	Replacing the Operation Fluid Reservoir	8-5
8.5	Exchanging the mains fuses	8-8
8.6	Replacing filters in the sniffer line	8-9
8.6.1	Replacing the felt discs of the capillary filter	8-9
8.6.2	Replacing the felt discs (with water protection tip)	8-11
8.6.3	Checking / replacing the sinter filter	8-11
8.7	Switching the capillary filter	8-12
8.7.1	Switching from metal to plastic capillary filter	8-13
8.7.2	Switching from plastic to metal capillary filter	8-14
8.8	Replacing the gas reservoir of the ECO-Check	8-14
<hr/>		
9	Annex	9-1
9.1	The gas library	9-1
9.2	Declaration of Conformity	9-10

Important Safety Precautions



Warning

Indicates procedures that must be strictly observed to prevent hazards to persons.



Caution

Indicates procedures that must strictly be observed to prevent damage to or destruction of the Ecotec E3000 leak detector.

Notice Indicates special requirements the user must comply with.

The INFICON Ecotec E3000 leak detector has been designed for safe and efficient operation when used properly and in accordance with this Technical Handbook. It is the responsibility of the user to carefully read and strictly observe all safety precautions described in this chapter and throughout this Technical Handbook. The Ecotec E3000 must only be operated in the proper condition and under the conditions described in this Technical Handbook.

It must be operated and maintained by trained personal only. Consult local, state, and national agencies regarding specific requirements and regulations. Address any further safety, operation and / or maintenance questions to our nearest office.



Warning

Presumed Risk:

If it is to be assumed that safe operation is no longer possible, the device is to be taken out of service and secured against unsupervised operation.

Notice This can e. g. be the case if:

- the unit has visible damage,
- fluid has gotten into the device,
- the device is no longer working,
- the device has been stored for an extended period of time under unfavorable conditions or
- after significant moving or transportation stresses.

Failure to observe the following precautions could result in serious personal injury:



Warning

Only 3-core mains cables having a protective ground conductor must be used. Operation of the Ecotec E3000 with the ground conductor unconnected is not permissible.



Warning

Do not stare into the LEDs of the sniffer line intentionally for extended times or at a close distance as this may cause permanent damage to the eye.



Warning

Danger of electric shock.

Don't touch voltaged parts with the sniffer tip. Test samples need to be disconnected from electricity before leak testing.



Warning

For all contacts of the I/O Port a maximum voltage of 60 V DC or 25 V AC must not be exceeded or reached to ground or ground equipment conductors. According to the type of in- or outputs lower voltages had to be accepted. For this, please refer to the information given in the responding chapters.



Warning

For all maintenance on the Ecotec E3000, the Ecotec E3000 must be disconnected from power.



Warning

Before exchanging the air filter the Ecotec E3000 must be disconnected from power.



Warning

Before exchanging the fuses the Ecotec E3000 must be disconnected from power.



Warning

Before exchanging the lubricant reservoir the Ecotec E3000 must be disconnected from power.



Warning

Dangerous gases pollute the machine.

So you must not use the machine for detecting toxic, acidity, microbiological, explosive, radioactive or other noxious matters.



Warning

Caution: Danger of explosion

Hydrogen forms a highly explosive gas mixture with air.

Great caution is necessary when using hydrogen! No smoking, no naked flames, avoid sparks.



Warning

Danger of explosion!

To use the Ecotec E3000 in explosion hazard areas could cause ignition of flammable mixtures.

The Ecotec E3000 must only be operated outside of explosion hazard areas.

Failure to observe the following precautions could result in damage to the equipment:



Caution

The Ecotec E3000 must not be operated while standing in water or when exposed to drip water. The same applies to all other kinds of liquids.

This Ecotec E3000 should only be used in rooms.



Caution

Avoid contact of the Ecotec E3000 with bases, acids and solvents as well as exposure to extreme climatic conditions.

**Caution**

Ensure sufficient air cooling (see also Section 1.2)

**Caution**

Before installation remove the transportation lock.

**Caution**

In order to ensure adequate ventilation of the Ecotec E3000, a space of at least 20 cm (8 in.) must be kept unobstructed to the sides. The clearance at the rear must be no less than 10 cm (4 in.). Moreover, the Ecotec E3000 handles for carrying the leak detector at the sides of the main unit must not be covered at any time as these acts as air inlet and outlet. Avoid the presence of heat sources in the vicinity of the Ecotec E3000.

**Caution**

Before connecting the Ecotec E3000 to the mains you must make sure that the mains voltage rating of the Ecotec E3000 coincides with the locally available mains voltage.

**Caution**

Do not suck in any liquids.

**Caution**

Permissible maximum input voltage PLC 28 V.

**Caution**

Permissible max. voltage and current for open collector outputs are: 28 V; 50 mA.

**Caution**

Maximum load rating relay outputs is 60 V DC / 25 V AC and 1 A per relay.



Caution

The air filter should be checked for contamination at least every 6 months and should be definitely exchanged after 2 years.



Caution

The lubricant reservoir may contain toxic substances from the pumped media. Please dispose of lubricant reservoir as required by local regulations. A Safety Data sheet for the lubricant is available on request.



Caution

Caution: Abrupt movements.
Abrupt movements can damage the running turbo pump.
Avoid abrupt movement and vibration of the instrument (e.g. running over cables, door sills) during operation and up to 4 minutes after switching off since the turbo pump can be damaged.

1 General Information

The Ecotec E3000 refrigerant leak detector is supplied ready for operation. However, we recommend that you carefully read the Technical Handbook to ensure optimum operating conditions right from the start. This handbook contains important information on functions, installation, start-up and operation of the Ecotec E3000.

1.1 Introduction

1.1.1 Intended Use

The Ecotec E3000 is a refrigerant leak detector for sniffer applications. It may be used to localise and quantify leaks in test samples if there is a refrigerant under an overpressure within the test sample and when searching the test sample with a sniffer probe from the outside (sniffer method). The use of this sniffer probe is mandatory for proper operation and it is available as an accessory (Cat. No. 525-001 to 525-004).



Caution

The Ecotec E3000 must not be operated while standing in water or when exposed to drip water. The same applies to all other kinds of liquids.

This Ecotec E3000 should only be used in rooms.



Caution

Avoid contact of the Ecotec E3000 with bases, acids and solvents as well as exposure to extreme climatic conditions.



Caution

Ensure sufficient air cooling (see also Section [1.1.2](#))

Proper use includes:

- Conformance with the technical specifications
- Use of standard and original accessories
- Observance of the instructions and guidelines contained in this document

1.2 Support by INFICON

INFICON Service

If equipment is returned to INFICON or an authorised INFICON representative indicate whether the equipment is free of substances damaging to health or whether it is contaminated.

If it is contaminated also indicate the nature of the hazard.

INFICON must return any equipment without a Declaration of Contamination to the sender's address. You will find an appropriate form at the next page.

General

We reserve the right to alter the design or any data given in this handbook.

The illustrations are not binding.



Declaration of Contamination

The service, repair, and/or disposal of vacuum equipment and components will only be carried out if a correctly completed declaration has been submitted. Non-completion will result in delay.
This declaration may only be completed (in block letters) and signed by authorized and qualified staff.

1 Description of product
Type _____
Article Number _____
Serial Number _____

2 Reason for return

3 Operating fluid(s) used (Must be drained before shipping.)

4 Process related contamination of product:

toxic	no <input type="checkbox"/> 1)	yes <input type="checkbox"/>
caustic	no <input type="checkbox"/> 1)	yes <input type="checkbox"/>
biological hazard	no <input type="checkbox"/>	yes <input type="checkbox"/> 2)
explosive	no <input type="checkbox"/>	yes <input type="checkbox"/> 2)
radioactive	no <input type="checkbox"/>	yes <input type="checkbox"/> 2)
other harmful substances	no <input type="checkbox"/> 1)	yes <input type="checkbox"/>

2) Products thus contaminated will not be accepted without written evidence of decontamination!

The product is free of any substances which are damaging to health
yes

1) or not containing any amount of hazardous residues that exceed the permissible exposure limits

5 Harmful substances, gases and/or by-products
Please list all substances, gases, and by-products which the product may have come into contact with:

Trade/product name	Chemical name (or symbol)	Precautions associated with substance	Action if human contact

6 Legally binding declaration:
I/we hereby declare that the information on this form is complete and accurate and that I/we will assume any further costs that may arise. The contaminated product will be dispatched in accordance with the applicable regulations.

Organization/company _____
Address _____ Post code, place _____
Phone _____ Fax _____
Email _____
Name _____

Date and legally binding signature _____ Company stamp _____

This form can be downloaded from our website.

Copies:
Original for addressee - 1 copy for accompanying documents - 1 copy for file of sender

INFICON GmbH

Bonner Str. 498, 50968 Cologne, Germany
Tel: +49 221 56788-112 Fax: +49 221 56788-9112
www.inficon.com leakdetection.service@inficon.com

zisa01e1-b (1106)

1.2.1 Service Centers

Algeria	jhj@agramkow.dk	Finland	jhj@agramkow.dk
Agramkow	Phone: +45 741 236 36	Agramkow	Phone: +45 741 236 36
Sonderborg	Fax: +45 744 336 46	Sonderborg	Fax: +45 744 336 46
Belarus	leakdetection.service@inficon.com	France	Christophe.Zaffanella@oerlikon.com
INFICON GmbH	Phone: +49 221 56788-112	OLV France	Phone: +33 476 351 584
Cologne	Fax: +49 221 56788-9112	Orsay	Fax: +33 476 351 584
Belgium	leakdetection.service@inficon.com	Germany	leakdetection.service@inficon.com
INFICON GmbH	Phone: +49 221 56788-112	INFICON GmbH	Phone: +49 221 56788-112
Cologne	Fax: +49 221 56788-9112	Cologne	Fax: +49 221 56788-9112
Brazil	fernandoz@prestvacuo.com.br	Hungary	adam.lovics@kon-trade.hu
PV Pest Vácuo Ltda.	Phone: +55 114 154 4888	Kontrade	Phone: +36 23 50 38 80
Santa de Parnaíba	Fax: +55 114 154 4888	Budaörs	Fax: +36 23 50 38 96
Bulgaria	leakdetection.service@inficon.com	India	asdash@hotmail.com
INFICON GmbH	Phone: +49 221 56788-112	Dashpute	Phone: +91 22 888 0324
Cologne	Fax: +49 221 56788-9112	400 064	Fax: +91 22 888 0324
Canada	reachus@vpcinc.ca	Ireland	reach.unitedkingdom@inficon.com
Vacuum Products Canada Ltd.	Phone: +905.672.7704	INFICON	Phone: +44 1254 678 250
Ontario	Fax: +905.672.2249	Blackburn	Fax: +44 1254 698 577
Central America	infoqro@meisa.com	Italy	davide.giovanetti@inficon.com
MEISA S.a. de C.V.	Phone: +52 44 22 25 42 80	INFICON GmbH	Phone: +39 045 6 40 25 56
Querétaro	Fax: +52 44 22 25 41 57	Castelnuovo	Fax: +39 045 6 40 24 21
China	reach.china@inficon.com	Israel	urimark@mark-tec.co.il
INFICON LTD	Phone: +852.2862.8863	Mark Technologies Ltd.	Phone: +972 35 34 68 22
Hong Kong	Fax: +852.2865.6883	Kiriat Ono	Fax: +972 35 34 25 89
INFICON LTD	Phone: +86.10.6590.0164	Japan	reach.japan@inficon.com
Beijing	Fax: +86.10.6590.0521	INFICON Co. Ltd.	Phone: +81.45.471.3396
INFICON LTD	Phone: +86.20.8723.6889	Yokohama	Fax: +81.45.471.3387
Guangzhou	Fax: +86.20.8723.6003		
INFICON LTD	Phone: +86.21.6209.3094		
Shanghai	Fax: +86.21.6295.2852		
Czech Republic	filip.lisec@inficon.com	Korea	reach.korea@inficon.com
INFICON GmbH	Phone +420 734 331 758	INFICON Ltd.	Phone: +82 312 062 890
Pilsen	Fax: +420 604 203 037	Sungnam city	Fax: +82 312 063 058
Denmark	jhj@agramkow.dk	INFICON Ltd.	Phone: +82 312 062 890
Agramkow	Phone: +45 744 336 36	Suwon City	Fax: +82 312 063 058
Sonderborg	Fax: +45 744 336 46	INFICON Ltd.	Phone: +82 312 062 890
Egypt	jhj@agramkow.dk	Cheonan City	Fax: +82 312 063 058
Agramkow	Phone: +45 741 236 36	Latvia	leakdetection.service@inficon.com
Sonderborg	Fax: +45 744 336 46	INFICON GmbH	Phone: +49 221 56788-112
Estonia	leakdetection.service@inficon.com	Cologne	Fax: +49 221 56788-9112
INFICON GmbH	Phone: +49 221 56788-112	Lithuania	leakdetection.service@inficon.com
Cologne	Fax: +49 221 56788-9112	INFICON GmbH	Phone: +49 221 56788-112
		Cologne	Fax: +49 221 56788-9112

Mexico MEISA S.a. de C.V. Querétaro	infoqro@meisa.com Phone: +52 442 225 42 80 Fax: +52 442 225 41 57	Spain Leybold Optics Ibérica Barcelona	richard.cunill@leyboldoptics.com Phone: +34 93 66 60 778 Fax: +34 93 66 64 612
Netherlands INFICON GmbH Cologne	leakdetection.service@inficon.com Phone: +49 221 56788-112 Fax: +49 221 56788-9112	Sweden Agramkow Sonderborg	jhj@agramkow.dk Phone: +45 741 236 36 Fax: +45 744 336 46
Norway Agramkow Sonderborg	jhj@agramkow.dk Phone: +45 741 236 36 Fax: +45 744 336 46	Syria INFICON GmbH Cologne	leakdetection.service@inficon.com Phone: +49 221 56788-112 Fax: +49 221 56788-9112
Poland VAK-POL & GAZ Sp. zo.o Pulawy	kamola@vakpol.com Phone: +48 60 23 15 212 Fax: +48 60 23 15 212	Taiwan INFICON Company Limited Chupei City, HsinChu Hsien	Susan.Chang@inficon.com Phone: +886.3.5525.828 Fax: +886.3.5525.829
Portugal INFICON GmbH Cologne	leakdetection.service@inficon.com Phone: +49 221 56788-112 Fax: +49 221 56788-9112	Tunisia INFICON GmbH Cologne	leakdetection.service@inficon.com Phone: +49 221 56788-112 Fax: +49 221 56788-9112
Republic of South Africa Vacuquip Randburg	vacuquip@hotmail.com Phone: +27 73 15 78 355	Turkey Agramkow Sonderborg	jhj@agramkow.dk Phone: +45 741 236 36 Fax: +45 744 336 46
Russia INFICON GmbH Cologne	leakdetection.service@inficon.com Phone: +49 221 56788-112 Fax: +49 221 56788-9112	Ukraine INFICON GmbH Cologne	leakdetection.service@inficon.com Phone: +49 221 56788-112 Fax: +49 221 56788-9112
Singapore INFICON PTE LTD. Singapur	reach.singapore@inficon.com Phone: +65.890.6250 Fax: +65.890.6266	United Kingdom INFICON Blackburn	reach.unitedkingdom@inficon.com Phone: +44 1254 678 250 Fax: +44 1254 698 577
Slovakia INFICON GmbH Pilsen	filip.lisec@inficon.com Phone +420 734 331 758 Fax: +420 604 203 037	United Arab Emirates INFICON GmbH Cologne	leakdetection.service@inficon.com Phone: +49 221 56788-112 Fax: +49 221 56788-9112
Slovenia Medivac Ljubljani	medivak@siol.net Phone: +386 15 63 91 50 Fax: +386 17 22 04 51	USA Inficon Inc. East Syracuse, NY	service.usa@inficon.com Phone: +1.315.434.1167 Fax: +1.315.434.2551
South America except Brazil MEISA S.a. de C.V. Querétaro	infoqro@meisa.com Phone: +52 44 22 12 36 15 Fax: +52 44 22 12 19 40	Inficon Inc. San Jose, CA Inficon Inc. Austin, TX	Phone: +1.408.361.1200 Fax: +1.408.362.1556 Phone: +1.512.448.0488 Fax: +1.512.448.0398

1.3 Unpacking

Unpack the Ecotec E3000 leak detector immediately after it has been received even if it is to be put into operation at some later date. Examine the shipping container for any external damage. Completely remove all packaging materials.

Notice: Retain the shipping container and the packaging materials in the event of possible complaints concerning any damages.

Check if the Ecotec E3000 leak detector is complete (see Section 1.3.1) and carefully subject it to a visual inspection. If any damage is discovered please immediately inform the forwarding agent and the insurers. If it is required to exchange the damaged part please contact our orders department.

1.3.1 Supplied Equipment

The Ecotec E3000 leak detector is ready for operation. Before installation please read Section 1.5. Included with the leak detector are the following items:

- Ecotec E3000 (main unit)
- Mains cord, 3m long
- Set of fuses (3 x 10 pcs.)
- Spare air filter
- 8 mm hexagonal wrench
- 19 mm ring wrench
- Documentation
 - Operating Instructions (kima22e1)
 - Technical Handbook Ecotec E3000 (kina22e1)
 - Spare Parts List Ecotec E3000 (kiua22d2)
 - Interface Description E3000 (kins22e1)

Notice: The sniffer line is available in different configurations and needs to be ordered separately in the desired length. The sniffer line is not part of the Ecotec E3000 shipment. (see Section 1.3.3 Accessories)

Notice: The ECO-Check reference leak is an accessory (see Section 1.3.3 Accessories) and needs to be ordered separately

Notice: For the Ecotec E3000RC version the display unit and the connecting cable are not part of the standard Ecotec E3000 shipment and need to be ordered separately (see Section 1.3.3)

1.3.2 Technical Data

Physical Data

Smallest detectable leak rate	0.05 g/a for refrigerants 0.002 oz/yr for refrigerants < 1×10^{-6} mbar l/s (helium)
Measurement range	6 decades
Detectable masses	2 - 200 amu
Mass spectrometer	Quadrupole mass spectrometer
Ion source	2 cathodes; iridium with yttrium oxide coating
Time constant of the leak rate signal	< 1 s
Gas flow through the capillary	160 sccm
Time until ready for operation	< 2 min

Electrical Data

Mains voltages and mains frequencies (fixed)	90 - 127 V, 50 / 60 Hz 115 - 140 V, 60 Hz 187 - 265 V, 50 / 60 Hz
Power consumption	≤ 300 VA
Type of protection	IP 20
Overvoltage category	II
Mains cord	2.5 m
Noise level	< 54 dBA

Other data

Dimensions (w x h x d) in mm	610 x 370 x 265
Weight	34 kg
Permissible ambient temperature (during operation)	10 °C to 45 °C
Permissible storage temperature	-20 °C to 60 °C
Max. rel. humidity	max. 80% for temperatures up to +31°C, decreasing linearly to 50% at +40%
Contamination level	II (according to IEC 61010 / Part 1: "normally only non-conductive pollution may occur. Occasionally, however, a temporary conductivity caused by condensation can be tolerated.")
Max. altitude above sea level	2000m

1.3.3 Accessories

Sniffer line for Ecotec E3000	Cat. No. / Ref. No.
SL3000-3, 3 m length	525-001
SL3000-5, 5 m length	525-002
SL3000-10, 10 m length	525-003
SL3000-15, 15 m length	525-004
Sniffer line for system integration (robot application)	525-015
Sniffer tips	
ST 312, 120 mm long, rigid	122 13
FT 312, 120 mm long, flexible	122 14
FT 200, 200 mm long, rigid	122 18
FT 250, 250 mm long, flexible	122 66
ST 385, 385 mm long, rigid	122 15
FT 385, 385 mm long, flexible	122 16
FT 600, 600 mm long, flexible	122 09
ST 500, 500 mm long, rigid, 45° angled	122 72
Water protection tip for sniffer	122 46
Holder for SL3000 sniffer line	525-006
ECO-Check reference leak for R134a	531-001
Calibrated sniffer leaks for single refrigerants, 2 - 5 g/a (16 g/a also available)	
R134a	122 20
R600a	122 21
R404A	122 22
R502a	122 23
R22	122 25
R23	122 26
R152a	122 27
R407C	122 28
R410A	122 29
R401A	122 30
R290	122 31
R744 (CO ₂)	122 32
10% Hydrogen (E-5 mbar/s)	122 33
Halon 1301 (R13B1)	122 34
HFO-1234yf	122 35
Calibrated sniffer leak for helium	
S-TL 4, approx. 1×10^{-4} mbar l/s	122 37
S-TL 5, range 10^{-5} mbar l/s	122 38
S-TL 6, range 10^{-6} mbar l/s	122 39

Calibrated leaks for forming gas (hydrogen) 10% hydrogen / 90% helium, range 10^{-5} mbar l/s	122 33
(Calibrated leaks for other refrigerants on request)	
External display unit for Ecotec E3000RC	
for bench top use	551-100
for rack mounting	551-101
Connecting cable for external display unit	
for Ecotec E3000RC, 5m	551-102
for Ecotec E3000RC, 1 m	551-103

1.4 Notes on How to Use This Handbook

1.4.1 Numbering of Figures

The references to diagrams, e.g. (2-1/6) consist of the Section No., Fig. No. and the Item No. in that order. For example (2-1/6) means: Section 2, Fig. 1 and Item No. 6 (here: mains switch).

1.4.2 Symbols of Vacuum Technology

In the following some important symbols of vacuum technology as used in this handbook are shown:

Vacuum pump in general

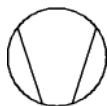

Diaphragm pump



Turbo molecular pump



Vacuum gauge



1.4.3 Definition of Terms

Main menu

This menu is shown first after operating the Menu push-button.

Sub-menus

Comprise all menus which may be accessed from the main menu. Unauthorized changes to many of these sub-menus may be prevented by a password (see also Section 4.5.1).

Menu item

A single menu line.

Default condition

Status of the Ecotec E3000 when supplied from the factory.

Service menu

Comprises the menu lines in the “Service” sub-menu. The service menu is accessed by scrolling in the basic menu using the navigation push-buttons (see also Section 3.2).

Autozero

Determination and compensation of the refrigerant background. With this function, the internal ZERO level of the leak rate signal is determined in order to avoid a readout of the internal refrigerant background and mistaking it as a properly measured value. If subsequently negative leak rates are obtained due to this correction, the stored offset values are changed so that ZERO will be the lowest value which can be obtained. In this way the values adapt automatically to a decaying background (adaptive background correction).

Internal background

The existing partial pressure in the measurement system. The level of the internal background is measured all the time and subtracted from the measured signal.

I•Guide Mode

In the I•Guide Mode different testing plans can be pre-programmed. During testing the operator is then constantly prompted for the next action and thus guided through the testing plan.

Unit under test

Test object that needs to be leak checked.

Display limit

Limits the measurement data displayed depending on the unit of measurement and the operator settings.

1.5 Instrument Views of the Ecotec E3000



Fig. 1-2 Instrument views of Ecotec E3000

Pos.	Description	Pos.	Description
1	Main display	4	Lemo Connector for sniffer line
2	Handle for carrying the Ecotec E3000	5	Speaker
3	ECO-Check reference leak		

1.6 Installation

1.6.1 Set up



Caution

The weight of the Ecotec E3000 exceeds 25 kg. It therefore should not be carried by one single person. The Ecotec E3000 may tip off its base and injure people. Place the Ecotec E3000 on a stable base.

How to remove the transportation lock:

The transportation lock is located on the bottom side of the Ecotec E3000 main unit and consists of a yellow knurled screws. Please remove this screw before starting-up the Ecotec E3000. The Ecotec E3000 is supplied ready for operation. Initial start-up is described in Section 3.1.



Fig. 1-3 Removing the transportation lock before starting



Caution

Before installation remove the transportation lock.



Caution

In order to ensure adequate ventilation of the Ecotec E3000, a space of at least 20 cm (8 in.) must be kept unobstructed to the sides. The clearance at the rear must be no less than 10 cm (4 in.). Moreover, the Ecotec E3000 handles for carrying the leak detector at the sides of the main unit must not be covered at any time as these acts as air inlet and outlet. Avoid the presence of heat sources in the vicinity of the Ecotec E3000.



Caution

Make sure that you can always reach the mains plug.

1.6.2 Mechanical Connections

ECO-Check Reference leak (optional)

Please insert the ECO-Check reference leak into the opening in the housing of the main unit. Make sure that the Sub-D plug is properly connected with the ECO-Check leak.

Notice: When properly inserted, the ECO-Check reference leak will still protrude by approx. 10 mm.

On first usage of your ECO-Check you need to initialize the use of this reference leak in the Ecotec E3000 software menu.

Please perform the following steps:

- 1** Insert the ECO-Check into the appropriate opening of the Ecotec E3000
- 2** In the software menu go to HISTORY & MAINTENANCE / REPLACE ECO-CHECK.

Notice: The Ecotec E3000 must be set to ADVANCED MODE for access to this submenu (See section 4.5.3). Go to SETTINGS / DISPLAY / USER MODE)

- 3** On the certificate, which is delivered with the ECO-Check, you will find a serial number and a 12-digit-code. Enter the serial number in the first line of the open submenu and the 12-digit-code in the second line and press OK.

Notice: The ECO-Check reference leak must be installed in the Ecotec E3000 when pressing OK.

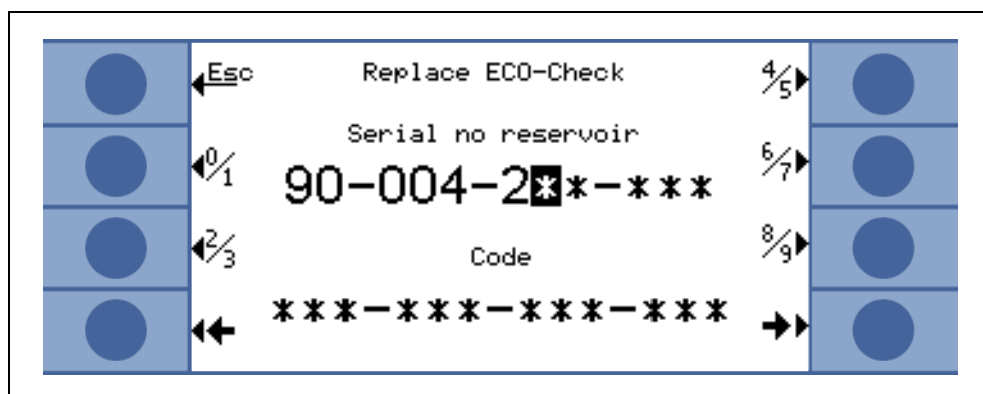

Fig. 1-4 Initializing the ECO-Check reference leak

SL3000 Sniffer line

In order to operate the Ecotec E3000 it is essential for the sniffer line to be connected. The connection for the sniffer line is located at the front of the Ecotec E3000 left of the ECO-Check reference leak.

Insert the plug into the opening with the red dot on the plug and the slot in the front cover aligned until the connector engages. To disconnect the plug, retract the coupling and remove the probe's line.

Holder for SL3000 sniffer line (optional)

An optional holder for the SL3000 sniffer line is available as cat.-no. 525-006. The holder may be installed on the right or left side of the main unit (for right- or left handed operators) as shown in Fig. 1-6.



Fig. 1-5 Usage of sniffer line holder

The installation is described in Fig. 1-6. There are two little slots on the front side at the very top area of the blue square front of the main unit. Hold the holder horizontally and then insert the two little hooks of the holder into the two slots (either on the right or the left side). With the hooks still inserted, let the holder flap down. It will automatically attach to the metal front by the magnet on the backside of the holder. Now insert the sniffer probe grip into the opening of the holder and let it sink down until it rests in the holder.



Fig. 1-6 Installation of sniffer line holder

Water protection tip (optional)

If you intend to perform leak testing on parts that are not completely dry (e.g. due to condensation after performance testing), we strongly recommend to use a water protection tip.

To install the water protection tip,

- 1** screw off the metallic capillary filter at the very end of the sniffer tip and
- 2** install the water protection tip instead.

Notice: Please do not forget to re-install the little rubber seal when switching to the water protection tip.



Fig. 1-7 Installing water protection tip

ECO-Check Reference leak (optional),
for helium and hydrogen only

If detecting helium or hydrogen, a ECO-Check reference leak may be used for internal calibration. The ECO-Check reference leak has to be inserted to the Ecotec E3000 (see section 2.3.3).

On first usage of your ECO-Check you need to initialize the use of this reference leak in the Ecotec E3000 menu.

Please perform the following steps:

- 1** Insert the ECO-Check into the appropriate opening of the Ecotec E3000
- 2** In the software menu go to HISTORY & MAINTENANCE / REPLACE ECO-CHECK.

Notice: The Ecotec E3000 must be set to USER MODE „ADVANCED“ for access to this submenu (See section 4.5.3). Go to SETTINGS / DISPLAY / USER MODE.

- 3** On the certificate, which is delivered with the ECO-Check, you will find a serial number and a 12-digit-code. Enter the serial number in the first line of the open submenu and the 12-digit-code in the second line and press OK.

For Ecotec E3000RC only

The Ecotec E3000RC has no built-in display unit but a connectors plate is mounted instead. Please connect the external display unit with the 5 m connecting table (Cat.-no. 551-102).

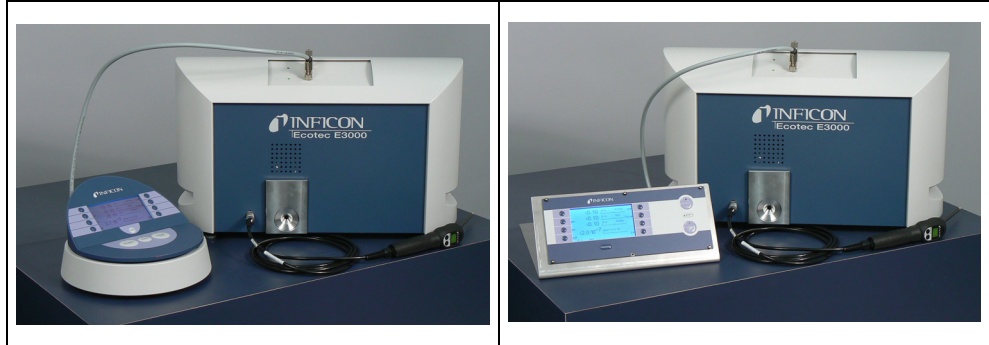

Fig. 1-8 Ecotec E3000RC with external display unit for: (a) bench top use (left side), (b) rack mounting (right side)

1.6.3 Electrical Connections



Fig. 1-9 Electrical connections

Pos.	Description	Pos.	Description
1	Headphone port	4	Name plate
2	I/O Port	5	Power switch
3	RS232 interface	6	Power connector

Notice: The local regulations for electrical connections must always be observed (in Germany VDE 0100). The mains voltage rating for the Ecotec E3000 can be read off from the name plate left of the power switch. The mains voltage setting of the Ecotec E3000 is fixed and can not be changed. A separate fuse for each of the mains conductors has been integrated into the mains socket (Fig. 2-1/6).

Warning

Only 3-core mains cables having a protective ground conductor must be used. Operation of the Ecotec E3000 with the ground conductor unconnected is not permissible.

The mains voltage is applied to the Ecotec E3000 via the detachable mains cable which is supplied with the Ecotec E3000. A main power socket is available for this purpose at the rear of the Ecotec E3000.



Caution

Before connecting the Ecotec E3000 to the mains you must make sure that the mains voltage rating of the Ecotec E3000 coincides with the locally available mains voltage.

1.6.4 RS232 Interface

The Ecotec E3000 is equipped with a RS232 interface which is located on the rear right side of the main unit. This interface is of the DCE type (Data Communications Equipment) and allows the connection of a PC for monitoring and data logging. The connection is provided through a commercially available Sub-D plug. For further information see "Interface Description Ecotec E3000" (kins22e1).

1.6.5 I/O Port

The I/O part allows communication with external equipment via analog data. For details see Section [7.2](#).

Through this connection some functions of the Ecotec E3000 can be controlled externally or measurement data or the Ecotec E3000 status may be communicated to external equipment.

Through relay changeover contacts the trigger levels as well as the operating mode (Ready) of the Ecotec E3000 may be monitored.

2 How the Instrument Works

2.1 Description of the Functions

The Ecotec E3000 is capable of detecting and quantifying the refrigerant sucked in through the sniffer line by means of a selective mass spectrometer.

The Ecotec E3000 is composed of the following principal subassemblies:

- a quadrupole mass spectrometer as the detection system
- a high vacuum pump system
- an inlet system for the gas flow
- the corresponding electrical and electronic subassemblies for supplying power and for signal conditioning.

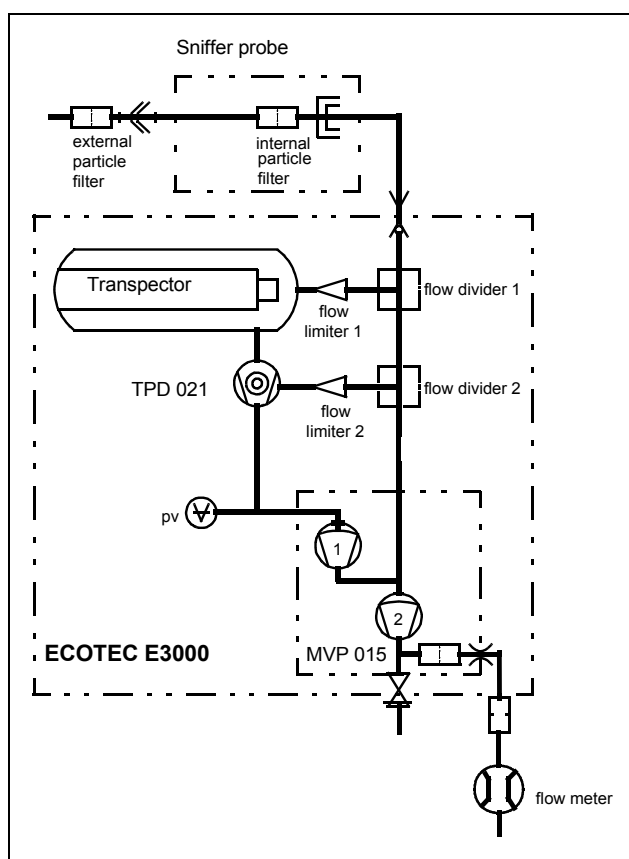

Fig. 2-1 Vacuum Diagram of the Ecotec E3000

The mass spectrometer only operates under high vacuum conditions, i.e. the pressure in the mass spectrometer must always stay below 10^{-4} mbar. This vacuum is generated by the turbo molecular pump with the support of the diaphragm pump. The pressure pV between the two pumps is measured with a piezo resistive measuring system and this pressure lies in the range between 4 to 10 mbar while in the measurement mode. This pressure must not exceed a value of 10 mbar as otherwise the turbo molecular pump will not be capable of maintaining the vacuum in the mass spectrometer.

2.2 Description of the Subassemblies

2.2.1 Backing Pump

A diaphragm pump in the Ecotec E3000 serves as the backing pump. All data and further information on this pump are given in the Operating Instructions of the pump. The backing pump generates the fore pressure required for operation of the turbo molecular pump and sucking in of the gas through the sniffer line.

2.2.2 Turbo Molecular Pump (TMP)

Built into the Ecotec E3000 is a turbo molecular pump with upstream compression stage. The turbo molecular pump generates the high vacuum necessary for operation of the mass spectrometer, whereas the compression stages permits relatively high backing pressures without impairing the ultimate pressure in the mass spectrometer. The TMP has a side connection. Thus a part of the taken in gas is pumped through the TMP into the first stage of the diaphragm pump. This gas load prevents the accumulation of water vapour in the diaphragm pump.

2.2.3 Mass Spectrometer

The Transpector™ mass spectrometer is composed of the ion source, the separator and the ion collector. The ion source ionizes neutral gas particles and generates an ion beam. The positively charged ions are accelerated out of the ion source and then enter the Quadrupole field. This field acts like a filter. Only the ions to which the system has been adjusted are able to meet the separating conditions and arrive at the ion collector, where their presence can be measured as a current by an electrometer amplifier. This current is the output signal which is then used to calculate the leak rates. Two cathodes have been integrated within the ion source. If one cathode fails the other is selected automatically.

2.2.4 Quadrupole Supply

This subassembly generates all the voltages and currents required for operation of the mass spectrometer. Faults in the mass spectrometer are detected and signalled to the control assembly. The control assembly monitors the mass spectrometer supply.

2.2.5 Control

The control assembly (microprocessor) is the central assembly of the Ecotec E3000's electronics. All other subassemblies are controlled and monitored by this assembly. The microprocessor which is located here is thus continuously informed about the status of the entire Ecotec E3000 and can respond accordingly. In order to accept commands from the operator and to output measured values and messages, the control subassembly is linked to the display unit.

2.3 Displays and User Interfaces

2.3.1 Main unit display

This subassembly is used to communicate with the operator. It accepts commands from the 8 keys on both sides of the display and outputs measurement results and messages via the display.



Fig. 2-2 Main unit display

Pos.	Description	Pos.	Description
1	Menu buttons 1 to 4	2	Menu buttons 5 to 8

for Ecotec E3000RC only

The Ecotec E3000RC has a connectors plate for the external display unit instead of the built-in main unit display. Two LED's left of the plug provide information about the status of the Ecotec E3000RC, even when the external display unit is disconnected:

- The green LED will indicate that the Ecotec E3000RC is in operation (switched on). The green LED will show continuous green light if an external display unit is connected and will blink if no external display unit is detected.
- The red LED will be blinking in case of an error message, continuous red light indicates a warning.

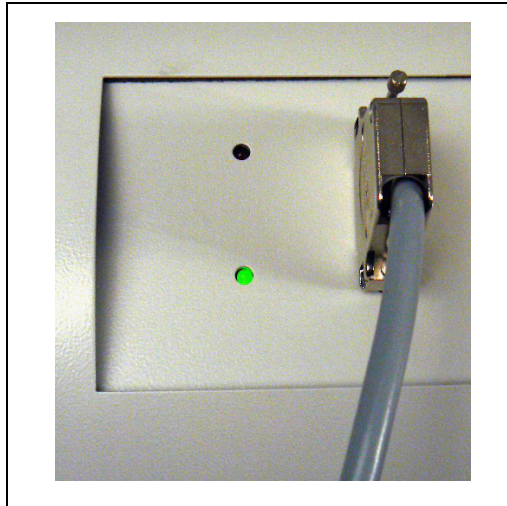

Fig. 2-3 Connector plate with LEDs

If no display unit is connected, error messages or warnings may be acknowledged by pressing both buttons of the sniffer line simultaneously.

The external display unit also offers four buttons:

- The START / STOP buttons have no function (the external display unit may also be used with other INFICON leak detectors which need these buttons)
- The MENU button will open the software menu.
- The ZERO button will set the current background reading to zero. (For details on the ZERO function see Section 4.4.1)

2.3.2 Sniffer line with probe display

The probe handle also offers a small display for operating the Ecotec E3000 remotely without access to the main unit during normal leak detection operation.

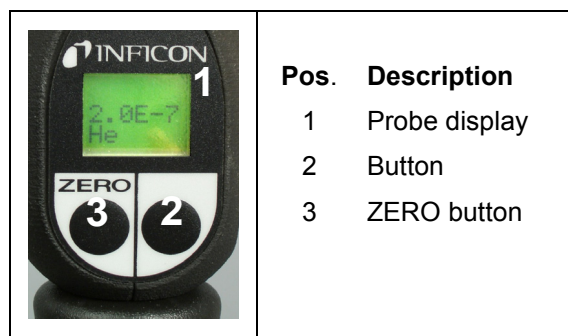

Fig. 2-4 Sniffer line with probe display

In addition to the display, the sniffer probe offers two press buttons. The left button will function as the ZERO button in any operating mode. By pressing the left button the current background reading is set to ZERO. The ZERO function can be disabled by holding the ZERO button for 2 seconds. A beep will indicate that the ZERO function has been successfully switched off. The ZERO function can be re-activated by pressing the ZERO button once again. For details on the ZERO function see section 4.5.1)

The right probe button is used for different functions depending on the current operating mode the Ecotec E3000 is set to.



Fig. 2-5 Probe handle

The probe handle also offers some LEDs in the flange of the sniffer tip in order to illuminate the location currently being leak tested.



Warning

Do not stare into the LEDs intentionally for extended times or at a close distance as this may cause permanent damage to the eye.

The LEDs offer some bundled light. The intentional staring suspends the lid closing reflex and also the eyes do not move anymore which may lead to overheating of the retina.

When looking into the LEDs „incidentally“ the eye is protected by the lid closing reflex. Also the permanent movement of the eyes prevents overheating and consequent damage of the retina.

2.3.3 Built-in ECO-Check reference leak

A built-in ECO-Check reference leak is available for the Ecotec E3000. The ECO-Check reference leak can be used for verifying the correct functioning of the Ecotec E3000 including the correct calibration and can also be used for re-calibrating the Ecotec E3000 if necessary.

The ECO-Check reference leak is inserted in the front of the housing. Insertion of the sniffer tip into the cone-shaped test leak opening is automatically detected via a light barrier.



Fig. 2-6 Built-in ECO-Check reference leak



Fig. 2-7 ECO-Check reference leak detached from the main unit for remote use

In cases where the main unit is placed in a difficult or inconvenient to access area the built-in ECO-Check reference leak can be removed from the main unit for easier access and connected to the main unit via the Sub-D connector with a commonly available extension cord. The ECO-Check reference leak can then be placed in an area where it is convenient for the operator to be reached.

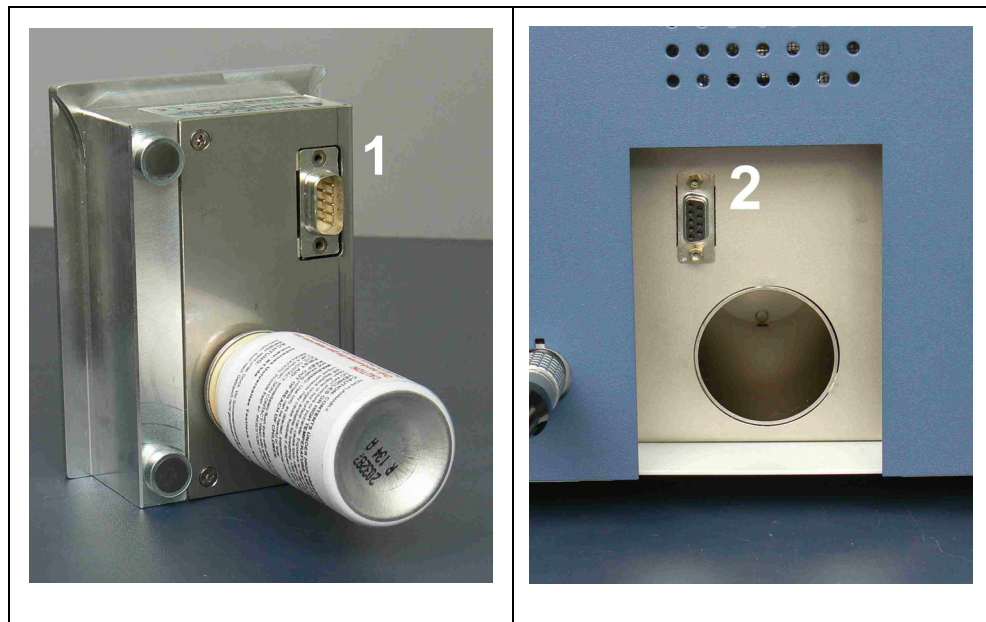

Fig. 2-8 Connections for remote use

Pos.	Description	Pos.	Description
1	Connector at built-in test leak	2	Connector at Ecotec E3000 housing

Notice: The ECO-Check reference leak is not part of the Ecotec E3000 shipment and needs to be ordered as a separate part no. (see section 1.3.3).

Notice: If you have not purchased the ECO-Check reference leak, warning 71 (“No communication with test leak”) will be issued on first start-up. Please go to SETTINGS / INTERFACES / ECO-CHECK and set the ECO-Check to “DISABLED” to prevent future warnings (see section 4.6.7)
 The Ecotec E3000 must be set to USER MODE „ADVANCED“ for access to this submenu (See section 4.5.3). Go to SETTINGS / DISPLAY / USER MODE.

3 Operation of the Ecotec E3000

3.1 Start-Up

Assemble the Ecotec E3000 (see Section 1.5). Connect the mains cord and the sniffer line, and then switch on the Ecotec E3000. The mains switch is located on the rear.

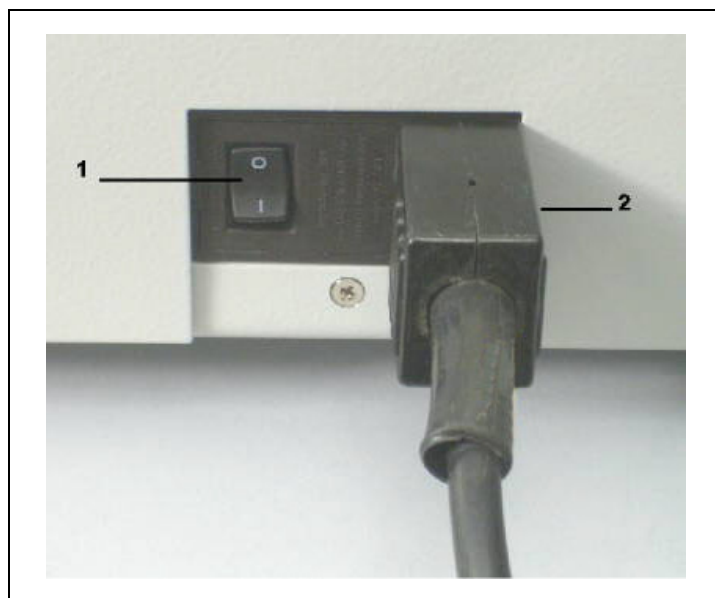

Fig. 3-1 Connection of the mains cord

Pos.	Description	Pos.	Description
1	Power Switch	2	Power cord connection

The Ecotec E3000 will automatically start a self test and run-up procedure. This takes about 2 minutes max. During the start-up the fore line pressure, the flow, the rotation speed of the turbo molecular pump will be displayed.

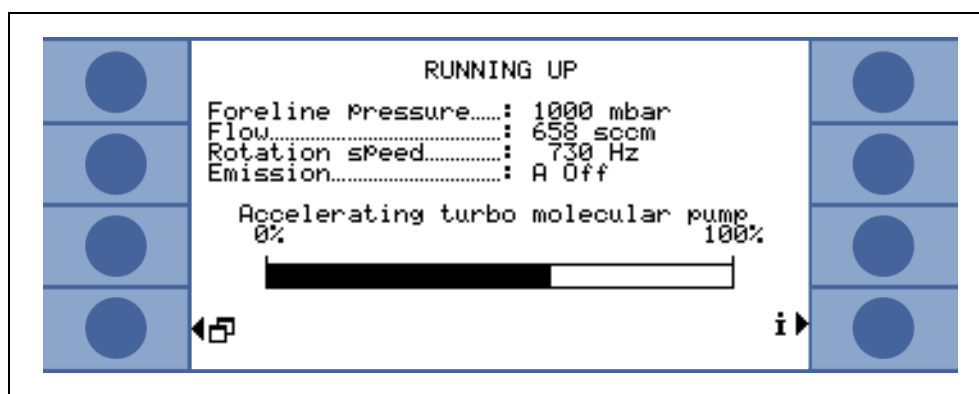

Fig. 3-2 Start-up menu

The individual steps are indicated on the display. In the case of unfavorable conditions, switching on of the emission may take several minutes.

After switching on and completion of the run-up phase the Ecotec E3000 will be ready to make measurements. There is no separate start function. The sniffer lines are designed to maintain an inlet pressure low enough to make measurements.

Notice: The Ecotec E3000 will only operate after having connected the sniffer line. Upon delivery, the data of the following gases are programmed in the factory for the measurements, and these gases are indicated on the display:

R134a, R600a, R22, He

This selection of gases may be changed at any time.

A calibration in accordance with Section 3.5 is recommended 20 minutes after having switched on the Ecotec E3000 on at the earliest (warm-up phase).

Notice: If you have not purchased the ECO-Check reference leak, warning 71 (“No communication with test leak”) will be issued on first start-up. Please go to Settings / Interfaces / ECO-Check and set the ECO-Check to “disabled” to prevent future warnings (see section 4.6.7)

3.2 Controls on the main display unit

All set-up and control functions are integrated into the main display unit via the menu structure. The functions of the 8 control keys are displayed on the LC display. During measurements the main interface is the probe handle display giving all necessary information for proper leak testing.

After start-up the Ecotec E3000 will automatically go into measurement mode.

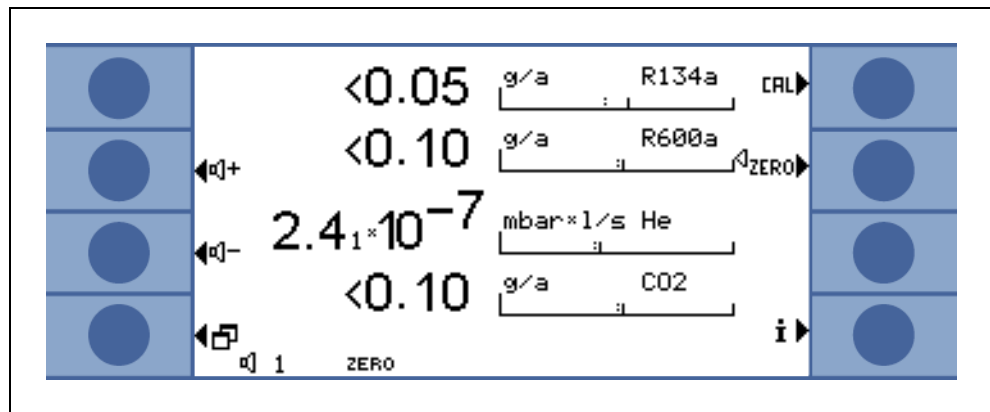

Fig. 3-3 Measurement screen in standard operation mode

Pos.	Description	Pos.	Description
1	Audio volume buttons	3	Calibration button
2	Menu button	4	Info button

Bar graph display

The currently detected leak rates for all selected gases will be display in a bar graph for each gas independently in logarithmic scale. On the upper left side of each bar graph the selected gas type is indicated. The currently selected trigger level is indicated by a black line, the currently selected search level is indicated by a dotted line. If the search level is exceeded the shape of a bell is displayed right of the gas name, if the trigger is exceeded the bell starts to blink (to “ring”). The pointer on the right side of the bar graphs indicates the currently detected gas which gas is also currently being displayed on the probe display.

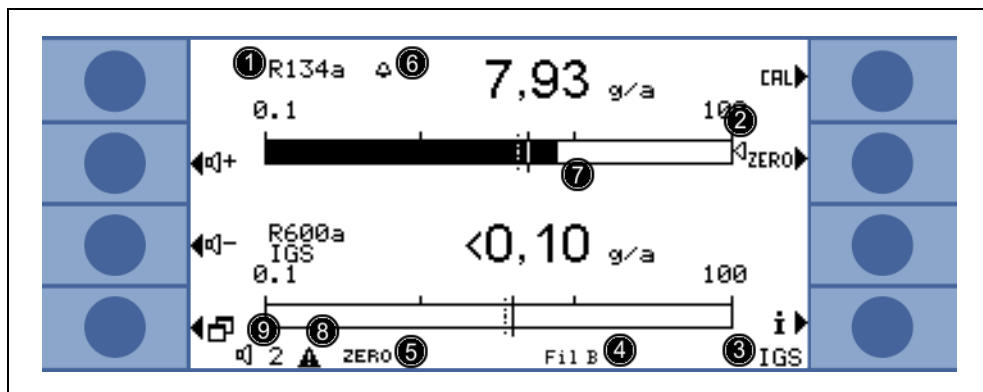

Fig. 3-4 Measurement screen with leak

Pos.	Description
1	Gas type
2	Indication of currently highest leak rate signal
3	Only when in ADVANCED mode and operating in IGS mode: indication of interfering gas being present
4	Indication that Ecotec E3000 has switched to filament B already
5	ZERO enabled
6	Indication of trigger level being exceeded
7	Bar graph
8	Indication of active warning
9	Audio volume level

Audio Volume Buttons

Warning

The hearing can be harmed by the audio alarm.
 The acoustic output can exceed a level of 85dB(A).
 Do only expose to the audio alarm for a short time or use ear protection.

The two center keys on the left side of the display allow to adjust the volume of the alarm sound at any time. When pressing any of the two buttons the currently selected volume will be demonstrated by the loudspeaker as well as by a bar graph in the status line. The selected value is also displayed as the first entry of the status line at the bottom of the display and only applies to the loud speaker in the main unit. For selecting different types of alarms see section 4.5.2.

Menu Button

The  button on the bottom left side of the display will open the main menu at any time. The menu mode offers the user many possibilities of entering Ecotec E3000 settings and special functions.

Cal Button

With the button on the upper right side of the display an external calibration of the Ecotec E3000 can be started at any time. For details on how to perform an external calibration see Section [3.5.3](#).

ZERO Button

When shortly pressing the ZERO button, the ZERO level for all selected refrigerants will be updated. Holding the ZERO button for more than 2 seconds will disable the ZERO function. In this case the ZERO indicator will be removed from the status line. For details on the ZERO function see Section [4.5.1](#).

Info Button

When pressing the  info button (bottom right side of the display) information on the status of the Ecotec E3000 will be displayed. For details see section [3.4.3](#).

Status line

In the bottom line of the main display status information is indicated. First the currently selected volume for the audio alarm is stated. Next, a small black triangle with an exclamation mark may indicate an active warning. If the ZERO function is enabled the word "ZERO" is listed in the status line next.

If the first filament (filament A) is burned and the Ecotec E3000 automatically switched to the second filament (filament B), an indication "Fil. B" is displayed in the status line.

Only when operating in ADVANCED mode and with IGS activated, the indication "IGS" is displayed in the status line as long as interfering gas is detected.

3.3 Controls on the probe display unit

On the display of the probe handle similar information as on the main display is shown.



Pos. Description

- | | |
|---|------------------------------------|
| 1 | Bar graph indicating the leak rate |
| 2 | Absolute leak rate |
| 3 | Gas currently detected |

Fig. 3-5 Sniffer display in standard operation mode

The currently detected leak rate is indicated as a bar graph. In a second line the numerical leak rate (in the same unit of measurement as on the main display) is shown. In the third line the type of gas detected is stated (e.g. R134a).

The sniffer probe offers two press buttons. By pressing the left button the current background reading is set to ZERO. The ZERO function can be disabled by holding the ZERO button until a beep will indicate that the ZERO function has been successfully switched off. The ZERO function can be re-activated by pressing the ZERO button once again. For details on the ZERO function please refer to [4.5.1. ZERO](#).

The right probe button allows to switch the bar graph display to the next of the up to four chosen gases to be detected. This button is inactive if only one gas has been selected. For details on this setting please refer to [Section 4.5.3](#).

3.4 Performing measurements

The Ecotec E3000 offers two modes of operation:

- The Standard Operation Mode (compatible to the EcotecII mode)
- The I•Guide Operating Mode



Warning

Danger of electric shock.

Do not touch voltaged parts with the sniffer tip. Test samples need to be disconnected from electricity before leak testing.



Caution

Do not suck in any liquids.

A water-protection tip is available (Cat.-No. 12246) which will protect the Ecotec E3000 against intake of liquids if necessary. For details on how to install the water protection tip see [1.6.2](#))

3.4.1 Standard Operation Mode

Provided the Ecotec E3000 has been set-up to meet the requirements of the particular application and it has been calibrated (see Section [3.5](#)), a measurement is run as follows:

First briefly operate the ZERO button on the sniffer probe. This will ensure that the Ecotec E3000 eliminates all interfering influences which may affect the ZERO level (i.e. the detection limit of 0.05 g/a).

Next hold the tip of the sniffer as close as possible to the suspected leak, if required the tip may even touch the test object.

If a welded seam or alike needs to be tested, the tip should be moved at a velocity of no more than 10 cm/s (4 inch per second) along the welded seam. The distance between tip and test sample should be as small as possible.

If a leak is detected the bar will grow. The Ecotec E3000 continuously compares the measured leak rates with the programmed trigger levels.

If the trigger is exceeded the background color of the probe display will change from green to red. At the same time an alarm sound will be released by the speaker in the probe handle and the probe handle will start to slightly vibrate.

As an additional indication of exceeding the trigger value the three white LEDs in the flange of the sniffer tip will start flashing.



Fig. 3-6 Sniffer display when detecting a leak

The display limits for the different units of measurement are summarized in the table below.

Unit	Lower display limit	Upper display limit
g/a	0.05	1,000
oz/yr	0.002	1,000
ppm	0.5	100,000
mbar l/s	1×10^{-7}	9.9×10^{-2}
Pa m ³ /s	1×10^{-8}	9.9×10^{-3}
atm cc/s	1×10^{-7}	9.9×10^{-2}
Torr l/s	1×10^{-7}	9.9×10^{-2}

The lower display limit may be increased by the user. Please refer to Section 4.5.3 for how to edit the lower display limit.

As soon as an acoustic alarm sounds, the tip should be removed from the spot being tested. After displaying a constant leak rate the ZERO button should be pressed again to repeat the test. Thus, a measurement error can be prevented and the leak can be located.

3.4.2 I•Guide Operating Mode

The I•Guide operating mode has been introduced to support the operator in applying proper sniffer leak detection technique.

The I•Guide operator guiding mode allows to store pre-programmed parameters for different units under test. The number of locations that need to be tested per specimen, the time each location needs to be tested for as well as the time required to move to the next location may be programmed. In addition, a maximum allowable global leak rate for the total unit under test is stored. In the I•Guide mode up to 10 pre-programmed testing procedures can be stored.

Notice: If the number of locations to be tested is set to 0, the Ecotec E3000 will operate in a continuous mode without checking for a global leak rate but still issue the timer signal for proper testing.

3.4.2.1 Starting the I•Guide Mode

To start the I•Guide Mode go to the main menu and choose SETUP I•GUIDE. In the opening menu go to the top line item and change the setting to ON with the left hand side push button and press OK. The Ecotec E3000 will automatically choose the first enabled I•Guide program in the list. A message screen will pop-up notifying the operator that I•Guide has been activated and therefore only one or two gases will be measured from now on (the gas selected in the I•Guide program you choose).

For how to set-up and I•Guide program please refer to Section 4.5.4.

To switch back to the Standard Operation Mode select "I•GUIDE OFF" and press "OK".

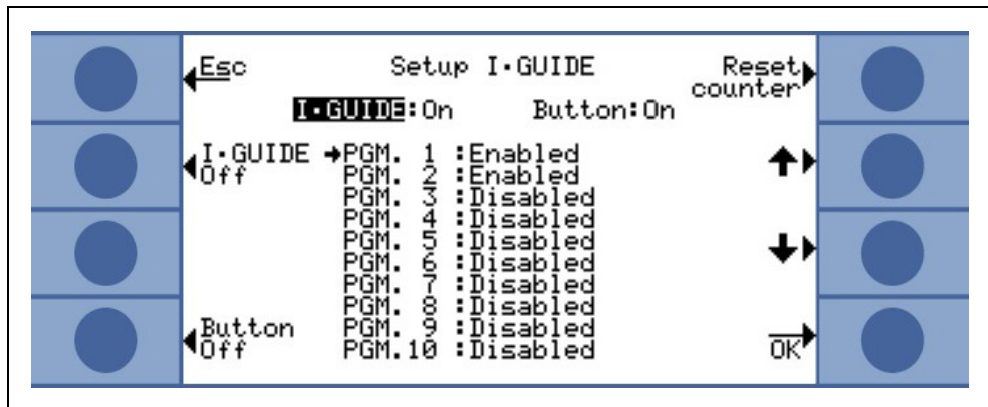

Fig. 3-7 Switching to I•Guide Mode

3.4.2.2 Selecting an I•Guide Program

To open the "SELECT I•GUIDE" menu press the "PROGRAM LIST" button on the right side of the display.

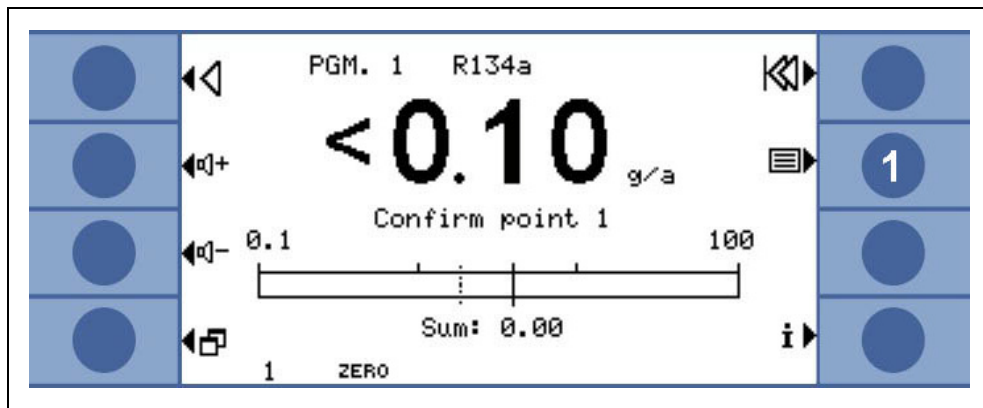

Fig. 3-8 Measuring Screen in I•Guide Mode

Pos.	Description
1	program list

In the opening "SELECT I•GUIDE" menu the currently selected program is indicated by an arrow in front of the program name. Highlight the program number you intend to use and press OK. The new program is now loaded.

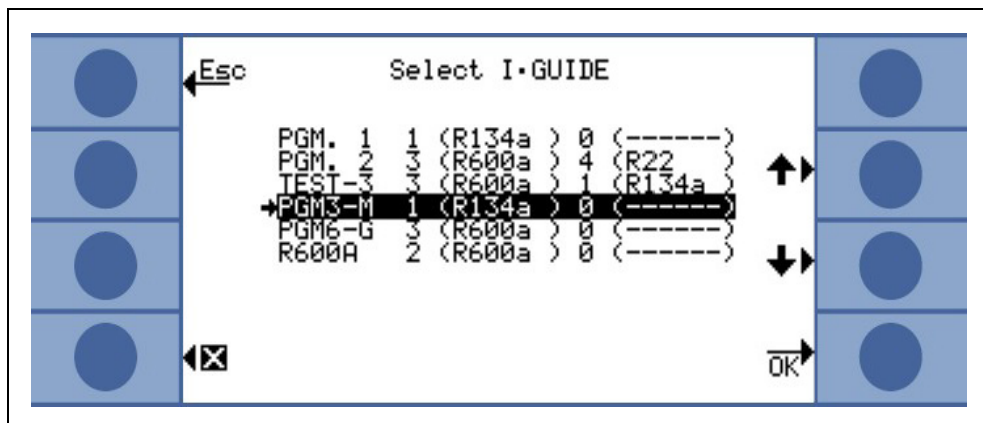

Fig. 3-9 Selecting an I•Guide program

3.4.2.3 Using an I•Guide Program

In the measuring screen of the I•Guide operating mode the selected program, the gas type stored in the program as well as the summarized global leak rate will be displayed.

In the I•Guide message line the Ecotec E3000 will prompt the user for action. First it will ask to move to the first testing position.

Also on the probe display the message "okay pos. 1?" will be shown. Please confirm with the right probe button that the sniffer tip has reached the right location.

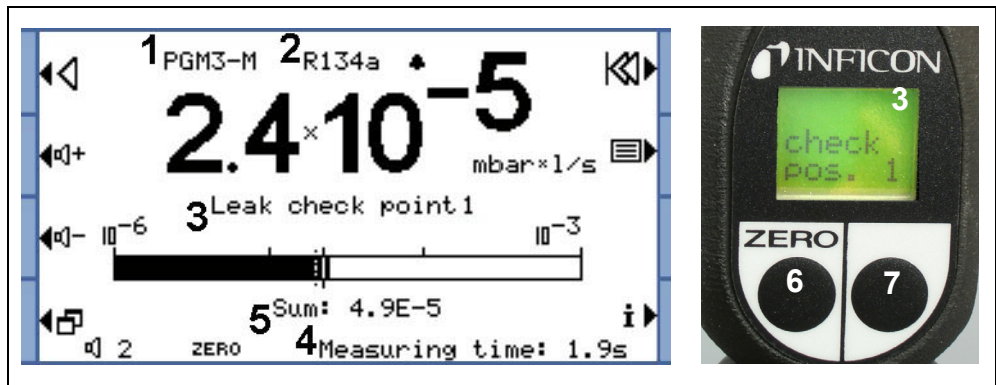

Fig. 3-10 I•Guide screens during measurement (one gas selected)

Pos.	Description	Pos.	Description	Pos.	Description
1	Selected program	4	Elapsing measuring time	6	ZERO button
2	Gas type stored in the selected program	5	Summarized global leak rate per unit under test	7	I•Guide button
3	I•Guide message				

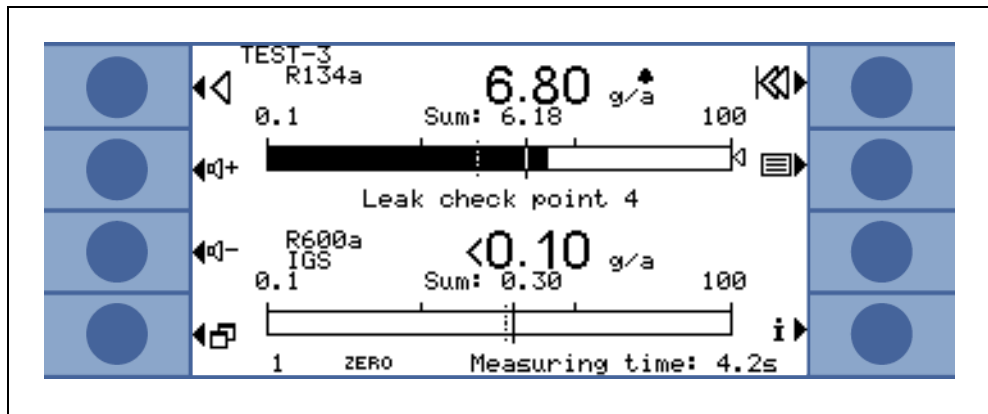

Fig. 3-11 I•Guide screen during measurement (two gases selected)

Pos.	Description	Pos.	Description
1	Selected program	4	Elapsing measuring time
2	Gas type stored in the selected program	5	Summarized global leak rate per unit under test
3	I•Guide message		

After the first location has been confirmed the message “leak check point1” will be indicated on the main unit display and the elapsing measurement time (stored in the testing program) will be shown in the lower part of the menu page.

Please make sure to hold the sniffer tip in the right testing location during the total measuring time. During this time a ticking sound will be issued by the main unit and a beep will indicate that the measuring time has elapsed and the sniffer tip can be moved again.

After the measurement time has elapsed the message “Move to point 2” will be displayed on the main unit. The probe display will read “tip to pos. 2”.

Please move the sniffer tip to the next testing location and if the wait time indicated in the display has elapsed, you may start the next measurement.

If the operator tries to start the next measurement before the wait time has elapsed,

the message "please wait" will be displayed in the message line until a next measurement is allowed.

Please confirm that the sniffer tip has been positioned properly by pressing the right probe button so that the next measurement can be started.

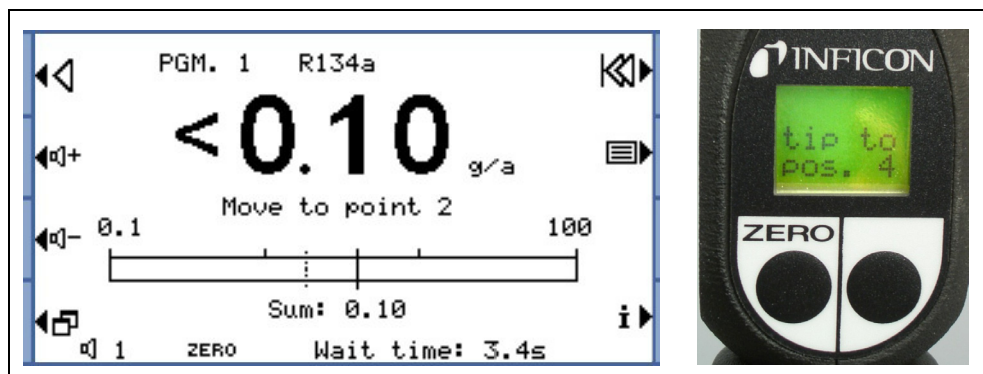

Fig. 3-12 I•Guide screens requesting the next location

After checking the pre-programmed number of locations, the result of the testing for the total unit under test will be displayed as shown in the following screen shots:

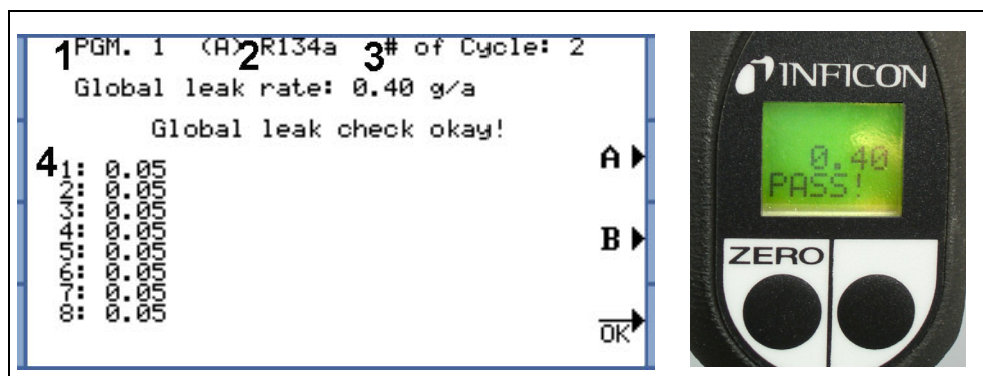

Fig. 3-13 Result of I•Guide program: unit under test passed

Pos.	Description	Pos.	Description
1	Program name	3	Cycle counter
2	Gas type	4	Results of each location tested

The selected testing program as well as the gas type stored in the program will be stated followed by the actual program cycle number.

The program cycle counter is increased by 1 after each completed cycle. The cycle counter may be reset manually (in the Setup I•Guide menu, see section 4.5.4).

The cycle counter is also automatically reset on power off.

Next the summarized global leak rate is started. If the global leak rate is lower than the global leak rate trigger the message "Global leak check okay!" will be displayed followed by the testing results for each tested location.

If the summarized global leak rate exceeds the global trigger the message "Global trigger exceeded!" will be displayed.

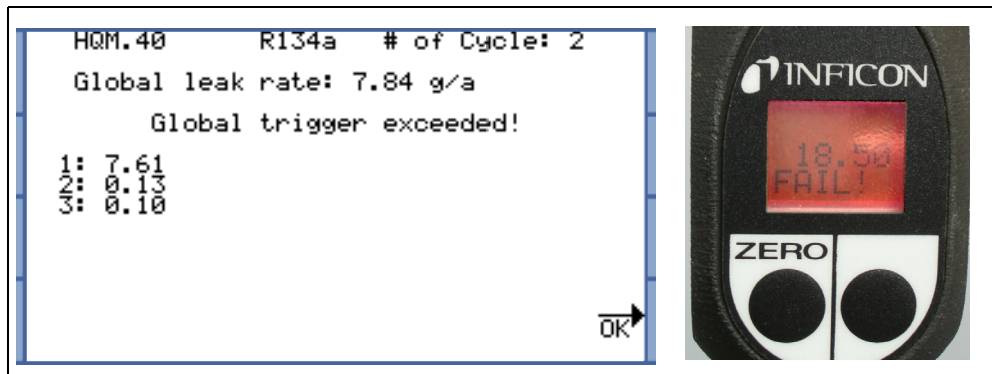

Fig. 3-14 Result of I-Guide program: unit under test failed

The sniffer line display will switch to red background color if the global trigger is exceeded (or at least one if two gases are selected for the program used). The gas exceeding the global trigger is displayed in the results list. However, you can switch between the results of the two different gases with the "A" and "B" buttons on the right side of the display. The display of the sniffer line will show the results for the two different gases alternating automatically. By pressing the right probe button the next testing cycle may be started.

3.4.3 The Info Page

By pressing the INFO button on the main display a general info page will open. Information on the software version used, the number of operating hours, the serial number, time & date and the currently selected alarm type will be stated. Also, the selected gases with their mass position will be listed. Gases that are disabled will be marked as such. For gases that are enabled also the currently selected trigger level will be stated.

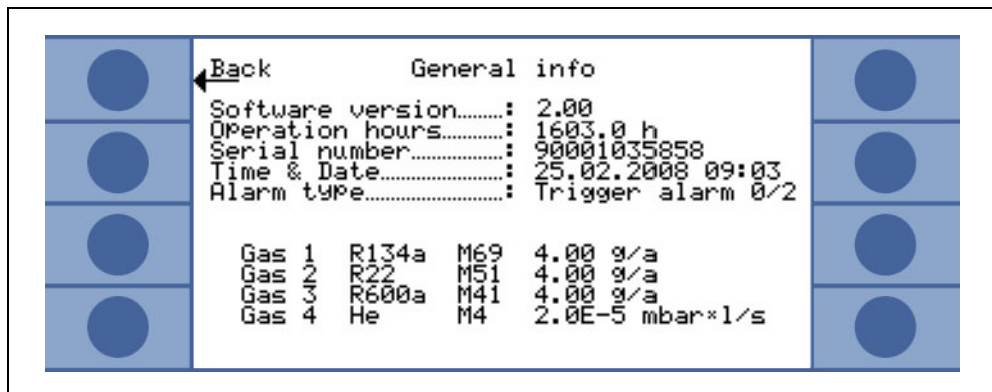

Fig. 3-15 Info page without errors or warnings

If an active warning exists this will be displayed in the info page instead of the gas info lines as shown below.

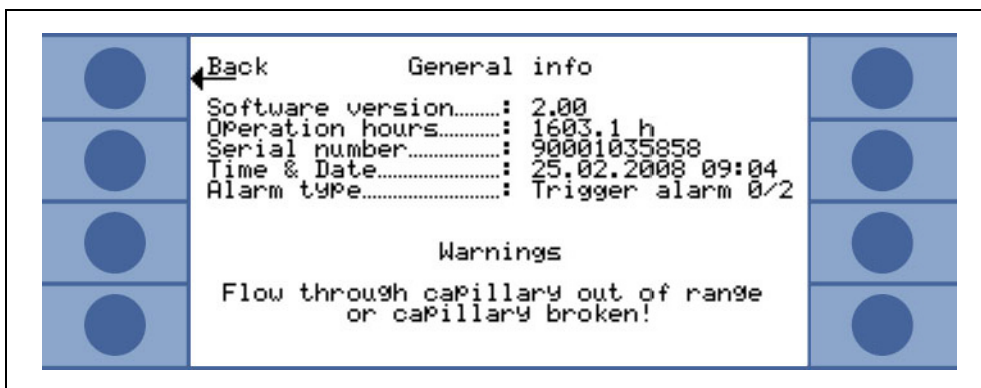

Fig. 3-16 Info page with active warning

When operating in I•Guide Mode, the info page will state information about the currently selected program: the selected program name, the gas used for this program, the number of points to be checked for this program, the selected measuring and wait time as well as the global trigger.

If two gases are selected for the I•Guide program, the gas type A/B and the global trigger A/B will be displayed alternatively.

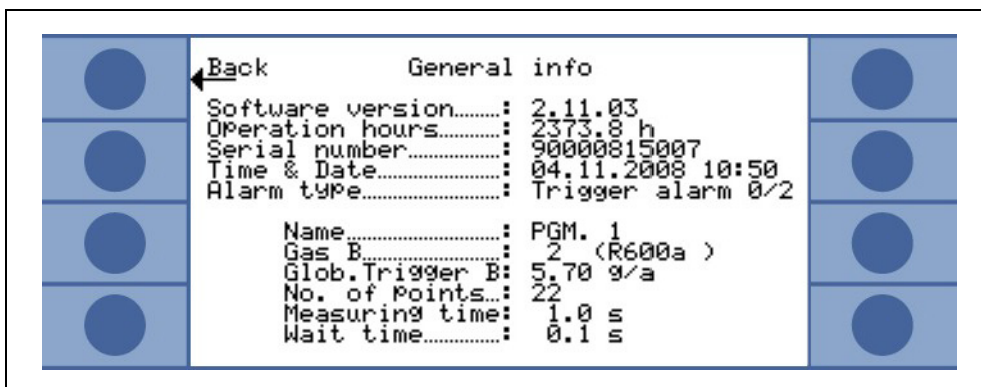

Fig. 3-17 Info page in I•Guide mode

3.5 Calibration and Self-Test

The Ecotec E3000 can be calibrated internally with the built-in ECO-Check reference leak or externally with an external calibrated leak (Cat. No. 122 20 - 122 35).

The built-in ECO-Check reference leak can be used for a self-test of the Ecotec E3000 as well as for calibration of gases that are measured at mass positions between 40 and 105 amu. If a gas is measured on a mass position below 40 amu or above 105 amu it will be permitted for internal calibration in the "EDIT GAS" menu.

A ECO-Check reference leak (cat. no. 521-001) maybe connected to the Ecotec E3000 remotely and be used for internal calibration and verification of the calibration (proof function) for helium and hydrogen. Internal calibration and verification may be performed accordingly.

Notice Do not calibrate the Ecotec E3000 during the first 20 minutes after start-up. Also a verification of the calibration may lead to wrong results in the first 20 minutes after start-up.

Only confirm and continue with the calibration or proof, if the real warm-up time has been longer than 20 minutes (e.g. after a quick restart of the Ecotec E3000)

Notice: When detecting hydrogen a longer warm-up time is required. For hydrogen please calibrate the Ecotec E3000 not before 1 h after start-up.

Notice: The accuracy of an internal calibration is less than the accuracy of a calibration with an external calibrated leak.

Notice: The ECO-Check reference leak is a temperature compensated leak. It must only be used when electrically connected to the main unit, either when inserted into its port or when connected to the main unit via a Sub-C extension cord. The leak rate printed onto the body of the ECO-Check is only valid at 20°C (68F) and will vary greatly with temperature.

To compensate for this the ECO-Check reference leak is equipped with a temperature sensor and a compensation curve is stored in the software which automatically compensates the test leak rate for changes in temperature when connected to the main unit.

A calibration or verification with the ECO-Check reference leak not being connected to the main unit will cause a wrong calibration of the Ecotec E3000 and / or will lead to wrong testing results.

3.5.1 Verifying a calibration (proof function)

Notice: The description of how to perform a verification applies to the use of the ECO-Check reference leak for detecting helium or hydrogen (forming gas) accordingly.

Notice: A verification can only be performed while the Ecotec E3000 is in measurement mode (not when the main menu is opened or during start-up).

If the sniffer tip is inserted into the opening of the ECO-Check reference leak a verification of the calibration (proof function) will be started automatically. While holding the sniffer tip in the test leak opening, the Ecotec E3000 will check the reading from the ECO-Check. Afterwards the operator will be requested to remove the sniffer tip from the leak opening.

Notice: Any time during the verification procedure an internal calibration may be started by pressing either the right sniffer probe button or the CAL button on the main display.

The results of the verification will be displayed in a summarizing screen.

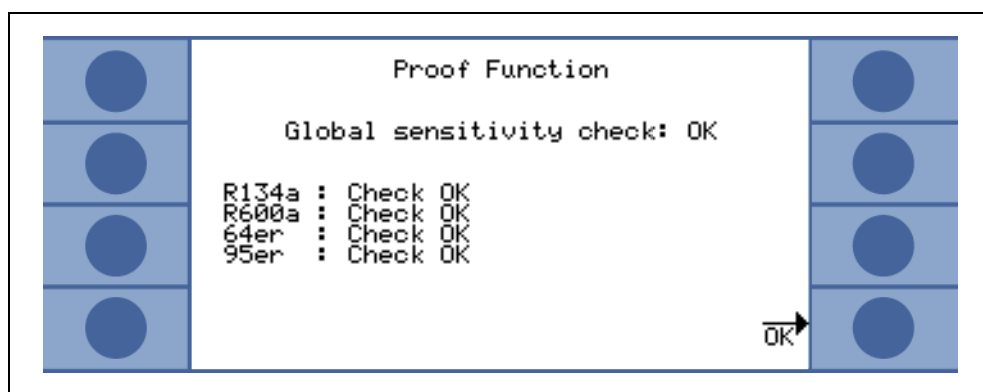

Fig. 3-18 Results of proof function

For gases that are enabled for internal calibration either “Check ok” or “Recalibration required” will be stated.

For gases that are disabled for internal calibration “Gas disabled” will be stated.

For gases that cannot be calibrated with the ECO-Check because of very high or very low mass positions, “gas specific check impossible” will be listed.

For returning to the measuring mode, please press the right probe button or press “OK” on the main display.

3.5.2 Internal calibration

Notice: The description of how to perform an internal calibration applies to the use of the ECO-Check reference leak for detecting helium or hydrogen (forming gas) accordingly.

Notice: An internal calibration can only be performed while the Ecotec E3000 is in measurement mode (not when the main menu is opened or during start-up).

If the sniffer tip is inserted into the opening of the ECO-Check reference leak with the right probe button pressed while in measurement mode, a calibration will be started automatically.

While holding the sniffer tip in the test leak opening, the Ecotec E3000 will first look for a baseline, find the Argon peak of the air and then measure the test leak.

Afterwards the operator will be requested to remove the sniffer tip from the leak opening.

After completion of the calibration a screen summarizing the results of the calibration will be displayed.

For gases that are allowed for internal calibration the old and new calibration factor and the old and new relative peak position will be stated.

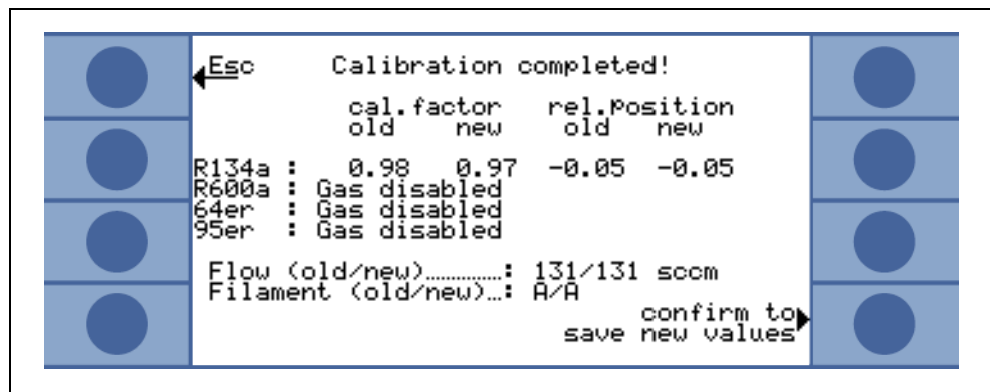

Fig. 3-19 Results of internal calibration

If a gas cannot be calibrated internally, in the listing the message “int. calibration impossible” will be displayed for these gases.

If a gas has been disabled for internal calibration in the “EDIT GAS” menu, the message “Gas disabled” will be displayed.

To avoid unintended overwriting of a previous external (more accurate) calibration, the operator needs to “confirm to save the new values”.

The saving of the new values may be password protected.

3.5.3 External calibration

For external calibration it is recommended to use leak rates > 2 g/a (0.07 oz/yr) when calibrating the Ecotec E3000.

Notice: If significantly increased backgrounds are prevalent in your production environment, larger leak rates for the calibration leak may be required.

Notice: If a calibration is started during the first 20 minutes after power on, a warning will be issued. Only confirm and continue with the calibration if the real warm-up has been longer (e.g. after a quick restart of the Ecotec E3000)

The external calibration is a semi-automatic process during which the user will have to follow some instructions. The calibration process may be started via the "CAL" - button from the measuring mode at any time (except when the menu is open or the function has been locked). A running calibration process may be cancelled by operating the "ESC" button.

After pressing the CAL button the currently selected gases with their selected mass positions will be listed. By pressing one of the four buttons on the right side of the display, the gas to be calibrated externally will be selected. Only gases that are currently enabled will be available for calibration.

Notice: If more than one gas is currently selected for measurement, a calibration will be required for each gas separately.

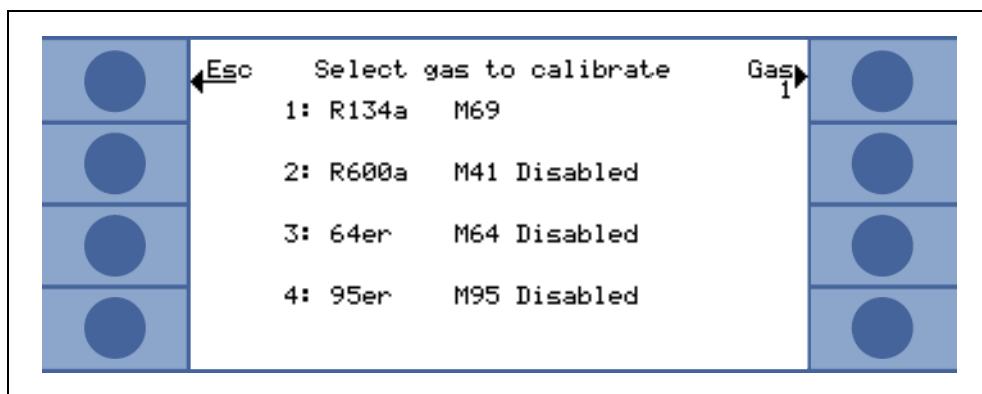

Fig. 3-20 Gas selection for external calibration

Please check whether the leak rate and the gas type displayed equals the leak rate and the gas type of the external leak you plan to use. If the leak rate is different press "EDIT LEAK RATE" and enter the correct leak rate value. Press "START" afterwards to begin with the calibration process.

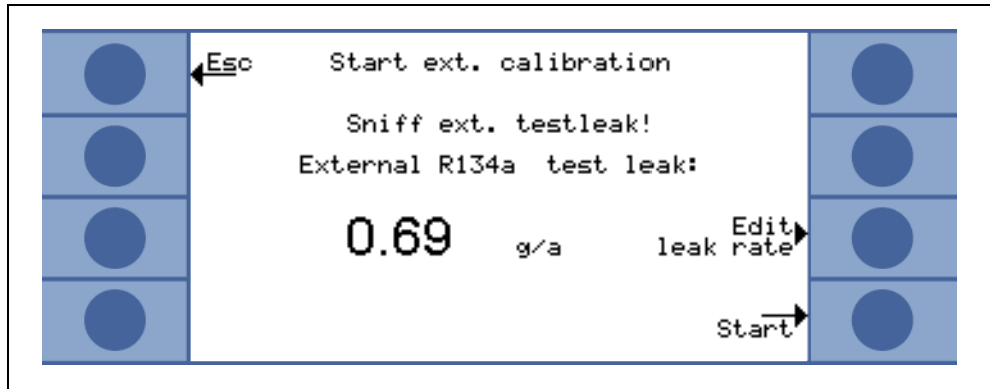

Fig. 3-21 Setting-up the leak rate of the external leak

Please hold the sniffer tip to the outlet of the external calibrated leak. Hold the sniffer tip steady and very close to the opening, however, do not clog the opening with the sniffer tip.

Some air also needs to enter the sniffer tip in addition to the refrigerant from the external calibrated leak. If the leak rate signal indicated by the bar graph is stable press "OK".

Keep holding the sniffer tip steady in front of the opening while the Ecotec E3000 reads the leak rate of the calibrated leak. During this time the text "Please wait..." will be displayed.

When the analysis of the calibrated leak signal is completed a message "sniff air!" will be displayed.

Remove the sniffer tip from the opening of the calibrated leak and hold the sniffer tip into the air, as far as possible from any sources of refrigerant. Wait until the bar graph shows a stable signal again and press "OK" once more.

Notice: When calibrating for helium or Hydrogen, the air signal will decrease only slowly and the time for the air signal to stabilize may be as long as 30 sec. Please do not confirm the air signal too early, as this will lead to a wrongly calibrated leak rate signal later.

A message "Please wait..." will be displayed until the calibration is finished. After completion a menu page summarizing the old values as well as the new values will come up. To activate the new calibration please "confirm to save new values".

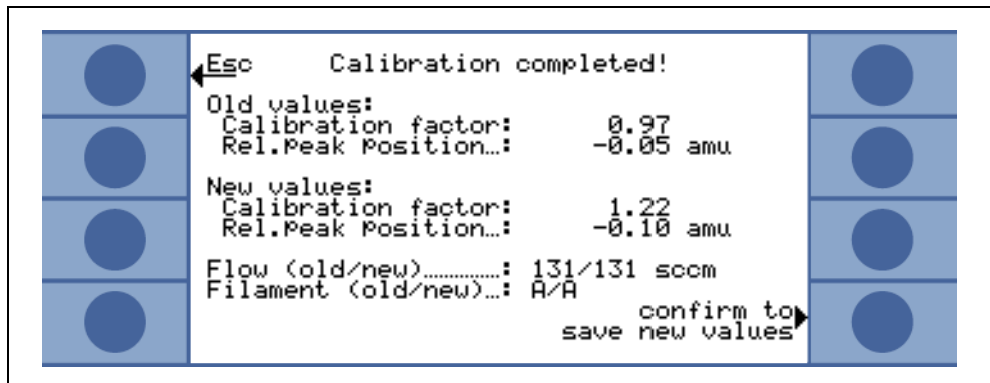

Fig. 3-22 Results of external calibration

In the opening info page the name of the gas, the currently selected trigger value and the measurement mode will be displayed.

This info is followed by the value for the lower display limit and the status of the internal calibration. In addition, the currently selected mass position, the calibration factor for the chosen gas, the date of the last calibration and type of the last calibration are listed.

Gases with mass positions between 40 and 105 amu may be calibrated via the built-in ECO-Check reference leak.

If a gas may be calibrated with the ECO-Check reference leak the line item „Internal cal“ will show “enabled”. If “disabled” is stated the selected gas is not set up to be calibrated internally but must be calibrated via an external test leak.

If the chosen gas can not be calibrated with the ECO-Check reference leak (because its mass position is below 40 amu or above 105 amu) this line will state “impossible”.

For details on how to perform an internal calibration see Section [3.5.2](#).

3.6 Shutdown

To shut down the Ecotec E3000, set the ON / OFF main switch (*Connection of the mains cord* [Fig. 3-1/6](#)) to the „0“ position regardless of the operating mode the Ecotec E3000 is currently running in. Nothing else is required.

It will take some minutes for the turbo molecular pump to arrive at standstill. During this time the Ecotec E3000 should be moved as little as possible.

The parameters entered are saved by Ecotec E3000. After switching on, the Ecotec E3000 will revert to the same status it was in when it was switched off before.

4 Equipment Settings

4.1 Menu Structure

By pressing the MENU button the main menu page opens. The following options will be displayed:

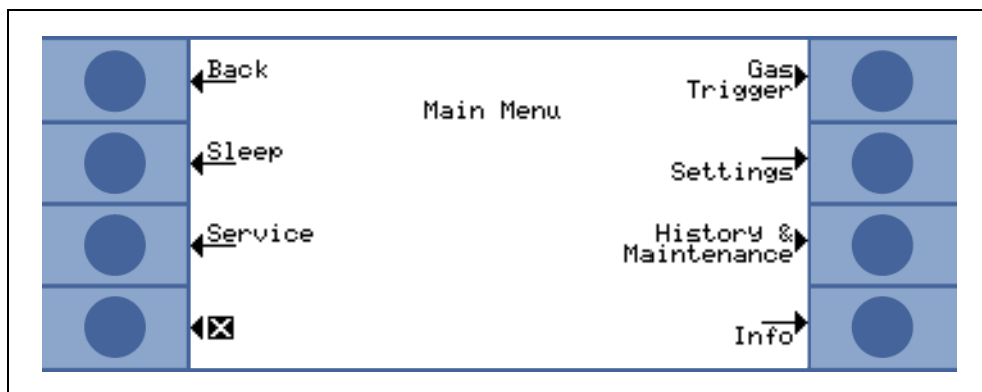

Fig. 4-1 Main menu screen

In the subsequent sub-menus the following frequently used functions will occur:

- ↑↓ The “up” and “down” keys allow scrolling through listed menu items. The currently selected menu item is highlighted by inverted colours. The “up” and “down” keys are also used for changing numerical values to a new setting.
- ? Help function – by pressing this key additional information on how to use this page can be displayed.
- Esc** Going back to the previous page while omitting any changes.
- Back** Going back to the next higher level in the menu structure.
- OK** Accepting a selected item from a list or accepting newly entered values.
- X** Exit all menus and return to main screen. If the menu button is pressed later on again, the software will jump to the menu page that has been exited by the **X** button. By pressing the back key the display will go back one level and finally all the way back to the measurement display page.

The menu structure of the main menu is illustrated on the following page for quick reference.

Main menu	2 Start / Sleep			
	3 Service			
	5 Gas Trigger	5 Gas 1	Name	8 Edit
		6 Gas 2	Mode (Gas)	
		7 Gas 3	Trigger&Unit	
		8 Gas 4	Search&Limit	
			Internal cal.	
			Mass	
			Cal. Factor	
			Last cal.	
			Cal. Mode	
			2 User gas	
			Name	
			Mass	
			Factor	
			Molecule mass	
	6 Settings	2 Vakuu & access	2 Zero	
			3 Zero time	
			5 Flow limits	upper limit
				lower limit
			6 Sensitivity check	
			7 Calibration	
			8 Change menu-PIN	
			3 Audio	2 Beep sound
		3 Audio intern		
		5 Audio Sniffer		
		6 Alarm type		
		5 Setup I-Guide	7 Volume	
2 I-Guide ON/OFF				
Meas. 1...10			3 Edit:	
			Name	
			Gas A	
		Gas B		
		Glob. Trigger A		
		Glob. Trigger B		
		No. of points		
	Measuring time			
	Wait time			
6 Miscellaneous	4 Button ON/OFF			
	2 Language			
	3 Time & date			
	4 Sniffer light			
	5 Pressure unit			
	6 Leak rate filter			
	7 Alarm delay			
	8 Wake up			
7 Display	2 Contrast			
	3 Peak hold			
	6 Gas select			
	7 User mode			
8 Interfaces	2 Control location			
	3 Recorder outputs			
	5 Setup PLC	5 Define PLC inputs		
		6 Define PLC outputs		
	6 RS232 protocol			
	7 Baud rate & End sign			
7 History & Maintenance	8 ECO-Check (1)			
	2 Error history			
	3 Calibration history			
	4 Select filament (1)			
	5 Maintenance interval			
	6 Maintenance history			
	7 Sniffer tip filter (2)			
	7 Confirm maintenance (1)			
8 Replace ECO-Check (1)				
8 Info	1/9 General data			
	2/9 Turbo molecular pump data			
	3/9 Transpector data			
	4/9 ECO Check data			
	5/9 Sniffer line data			
	6/9 I/O-Port data			
	7/9 Analog data			
	8/9 Analog data (2)			
	9/9 Info RS232			
		CAL-->	External Calibration Adjust IGS (2)	

(1) only in user mode "Advanced"

(2) only in user mode "Standard"

4.2 Sleep Mode

When pressing the SLEEP button in the main menu the Ecotec E3000 will go into sleep mode. The sensor will be shut off and all pumps will be powered down. However, the Sleep mode menu is still accessible.

The SLEEP button will then be replaced by a START button.

By pressing the START button the Ecotec E3000 will be brought back up into measurement mode.

Notice: The sleep mode does not allow the electrical components to hold their operating temperature. Therefore, accurate measurements are only possible again after 20 minutes warm-up time after restarting.

Notice: During Start-up and when in measurement mode, the Ecotec E3000 may be put to sleep by keeping the lower left button of the main display pressed and now pressing the lower right button.

4.3 The Service Menu

The service menu is password protected. When entering the service menu a PIN is required to be entered. The service menu should only be used by trained service personnel.

The PIN for entering the service menu will be distributed during service training. Please refer to the service documentation for the submenus and functions of the service menu.

4.4 Selecting gases and setting gas triggers

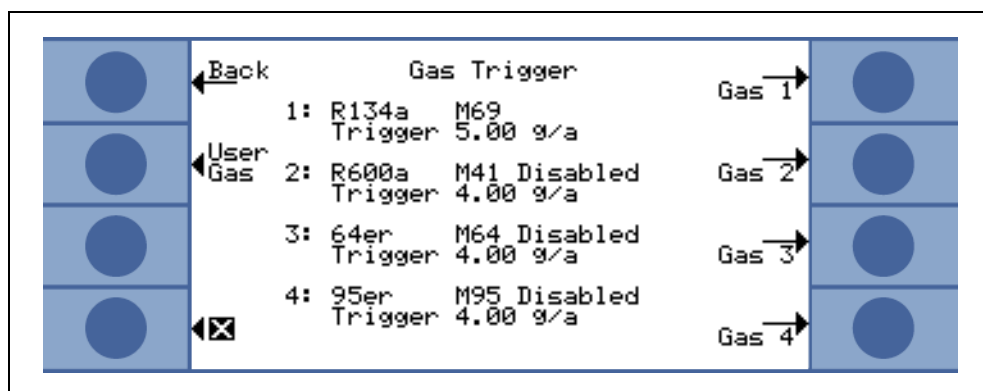

Fig. 4-2 Setting-up gases and trigger values

The Ecotec E3000 can detect up to four gases simultaneously. In the GAS TRIGGER menu the chosen gases are displayed with their currently chosen mass position and their current trigger value. If a gas is currently disabled for measurement this is also stated following the mass position.

4.4.1 Editing gas parameters

When pressing one of the “GAS1” to “GAS4” buttons an info page regarding the corresponding gas will open.

Changes to the current settings can be made by scrolling to the line item to be changed by use of the “up” and “down” keys and selecting the highlighted line item by pressing the “EDIT” key.

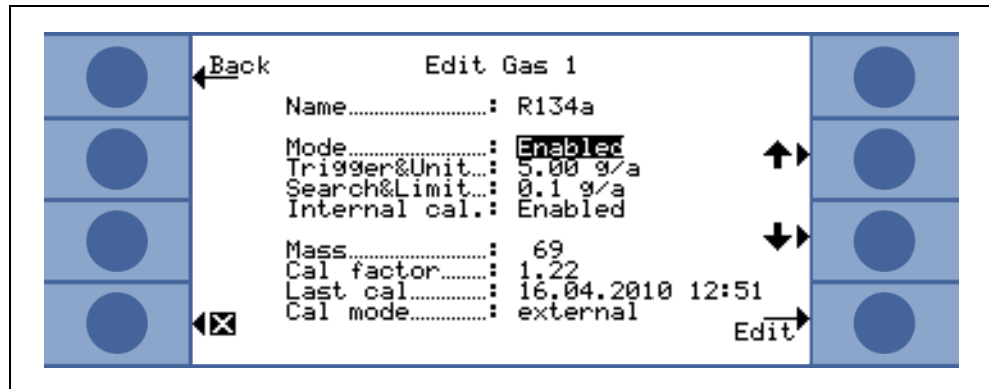

Fig. 4-3 Editing Gas 1

In the opening info page the name of the gas, the currently selected trigger value and the measurement mode will be displayed. This info is followed by the value for the lower display limit and search level and the status of the internal calibration. In addition, the currently selected mass position, the calibration factor for the chosen gas, the date of the last calibration and type of the last calibration are listed.

Gases with mass positions between 40 and 105 amu may be calibrated via the built-in ECO-Check reference leak. If a gas may be calibrated with the ECO-Check reference leak the line item „Internal cal“ will show “enabled”. If “disabled” is stated the selected gas is not set up to be calibrated internally but must be calibrated via an external test leak.

If the chosen gas can not be calibrated with the ECO-Check reference leak (because its mass position is below 40 amu or above 105 amu) this line will state “impossible”. For details on how to perform an internal calibration see Section 3.5.2.

4.4.2 Removing / adding a working gas

A selected gas can be removed from the main display by setting the MODE in the GAS EDIT menu to “disabled”. If you want a gas to be included in the list of measured gases again, please set the Mode back to “enabled”.

When choosing the “NAME” line of the info page and pressing “EDIT” the gas library will open and a new gas can be selected from the list of pre-programmed gases. You can scroll through the list by the “up” and “down” keys. For faster access also scrolling through the columns of the list is possible by the “left” and “right” keys. The currently highlighted gas is selected by pressing the “OK” button. The menu can be exited without changes by the use of “ESC” button.

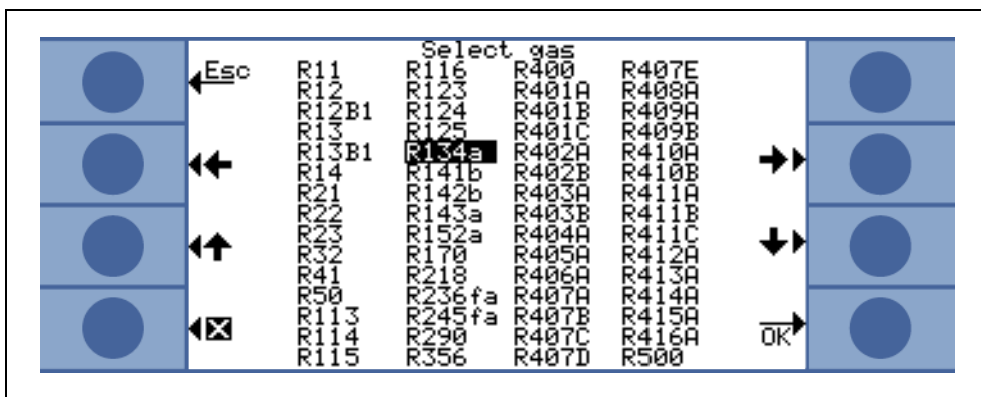

Fig. 4-4 The gas library

Six open positions for user-programmable gases can be found at the bottom of the list.

Working with gas equivalents
(for helium and hydrogen only)

When working with helium or hydrogen as a tracer gas you may also display the detected leak rate in a GAS EQUIVALENT leak rate, e.g. as R134a EQUIVALENT. For setting up a gas EQUIVALENT leak rate first select helium or hydrogen as the GAS TYPE (from the gas library), then go to the MODE line item and press EDIT. In the opening submenu you now have the choice of selecting ENABLE, DISABLE or EQUIVALENT NAME. By pressing EQUIVALENT NAME, the gas library will open again and you may select the appropriate gas EQUIVALENT NAME.

Notice: If a gas equivalent has been selected, the gas type will be displayed as the tracer gas followed by the equivalent in parenthesis in all menus.

Example: He (R134a)

In the EDIT GAS submenu you can now enter the TRIGGER value in the refrigerant equivalent value.

In the measurement screen the gas type will now be displayed as refrigerant equivalent leak rate.

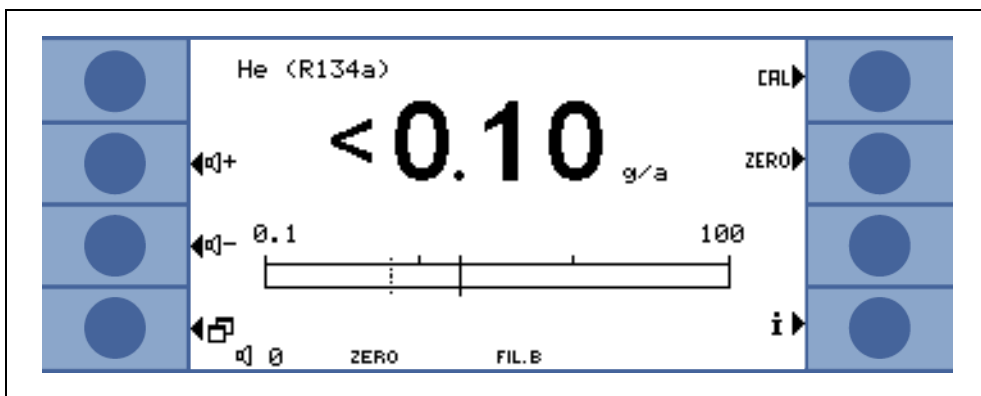

Fig. 4-5 Example of measurement screen when working with helium in refrigerant equivalent leak rates

If you are working with diluted helium or hydrogen as your tracer and / or your helium / hydrogen testing pressure is different from your gas equivalent fill pressure later on, you may also enter gas EQUIVALENT SETTINGS. The gas EQUIVALENT SETTINGS menu button will only be available after an EQUIVALENT NAME has been selected.

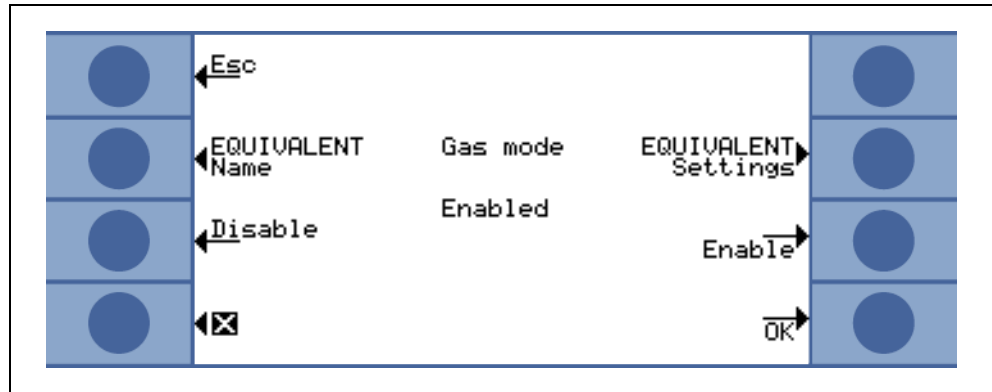

Fig. 4-6 Entering the EQUIVALENT SETTINGS submenu

In the EQUIVALENT SETTINGS submenu the HELIUM (or HYDROGEN) fill pressure, the fill pressure for the EQUIVALENT refrigerant later on and the CONCENTRATION of helium (hydrogen) used can be entered.

In the lower right corner the CORRECTION FACTOR (from helium / hydrogen to refrigerant) will be displayed.

If a set of parameters is entered that exceeds the boundaries of the Ecotec E3000 the CORRECTION FACTOR will be displayed in inverted colours. In this case, adjust the parameters until the CORRECTION FACTOR is displayed in normal colours again.

Press OK if all parameters are as desired.

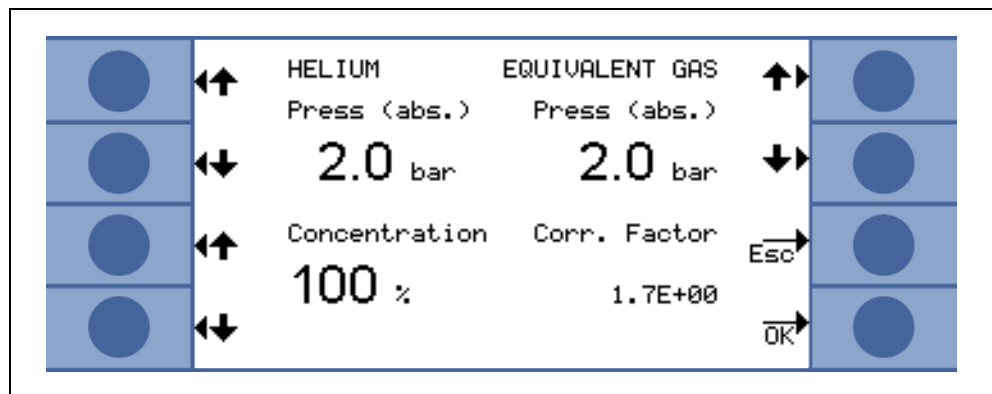

Fig. 4-7 Setting up GAS EQUIVALENT parameters

Notice: This menu should also be used when working with diluted helium / hydrogen, even when not working with refrigerant equivalent leak rates.

Notice: This menu should be used at any time when the helium / hydrogen fill pressure in pre-testing differs from the refrigerant fill pressure later on to display the correct leak rate value, even if the leak rate is still displayed as a helium / hydrogen leak rate.

4.4.3 Selecting trigger values and units of measurement

In the "EDIT GAS" info page the TRIGGER / UNIT sub-menu page will open by selecting the "TRIGGER" line item. You can change the trigger level setting by the use of the left "up" and "down" keys. The correct settings must be confirmed by the "OK" button. You can leave the sub-menu without making any changes by using the "ESC" key.

The ranges the trigger can be set to is listed in the following table.

Unit	Lower trigger limit	Upper trigger limit
g/a	0.1	1,000.0
oz/yr	0.004	100.00
ppm	1	999999
mbar l/s	2×10^{-7}	9.9×10^{-2}
Pa m ³ /s	2×10^{-8}	9.9×10^{-3}
atm cc/s	2×10^{-7}	9.9×10^{-2}
Torr l/s	2×10^{-7}	9.9×10^{-2}

Default value: 4.0

The leak rate unit can be changed by the use of the right "UP" and "DOWN" keys. Available leak rate units include mbar l / s, Pa m³ / s, Torr l / s, atm cc / s, g/a, oz/yr, ppm.

Default unit: g/a

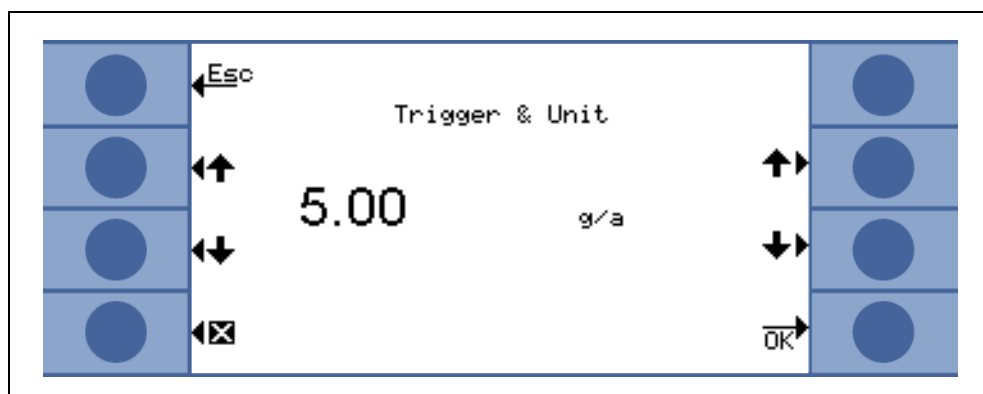

Fig. 4-8 Setting-up trigger level + unit of measurement

Pos.	Description	Pos.	Description
1	Increasing the trigger value	3	Changing the unit of measurement
2	Decreasing the trigger value	4	Changing the unit of measurement

4.4.4 Selecting the search level and the lower display limit

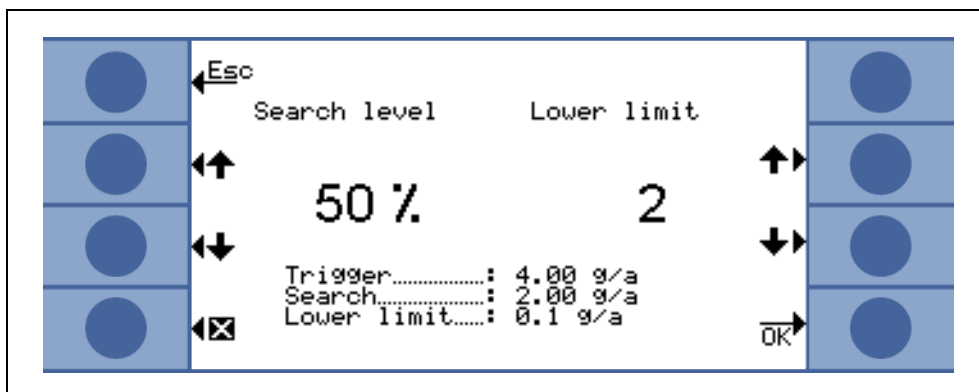

Fig. 4-9 Editing the search level and the lower display limit

The SEARCH LEVEL as well as the LOWER DISPLAY LIMIT can be edited by going to the SEARCH & LIMIT line item in the EDIT GAS submenu and pressing EDIT.

The SEARCH LEVEL is an additional warning level which can be entered as a percentage of the trigger level.

A warning signal will be issued for leaks that are below the trigger level but above search level in order not to miss small leaks.

The SEARCH LEVEL may be set to values between 5 and 100 % with the two UP and DOWN buttons on the left side of the display. The absolute value of the search level is displayed at the bottom of the menu page.

Default value: 90%

For each gas the lower display limit may be edited with two UP and DOWN buttons on the right side of the display. The absolute value of the lower display LIMIT is displayed at the bottom of the menu page. Available factors are 1, 2, 5, 10, 20, 50, 100.

4.4.5 Enabling / disabling internal calibration

To enable or disable the internal calibration go to the INTERNAL CAL line item in the EDIT GAS menu page and press enter.

In the opening menu page enabled or disabled can be selected.

If an internal calibration of a chosen gas is not allowed (as the corresponding mass position is outside the 40 to 105 amu range) the INTERNAL CAL line item in the EDIT GAS menu page will state "impossible" and this function will not be available.

4.4.6 Selecting an alternative mass position

When choosing a gas from the gas library a default mass position for the gas to be detected will be chosen automatically.

In cases of cross sensitivity with other substances in your leak testing environment it may be advisable to choose an alternative mass position for detecting the required gas.

A list of all available gases with their default and alternative mass positions is available in Section 9 (gas library).

The selected mass position can be changed by scrolling to the "MASS" line item in the "EDIT GAS" sub-menu and pressing the "EDIT" key.

In the following display page the available different positions for the selected gas can be scrolled with the "up" and "down" keys.

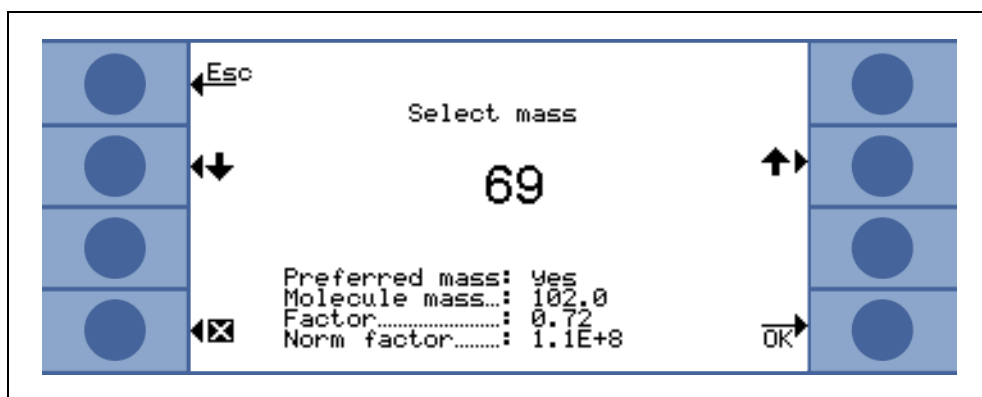

Fig. 4-10 Selecting an alternative mass position

Below the selected mass it is indicated whether or not this is the preferred mass.

In addition, the mol mass of the chosen gas is stated followed by the size of the peak relative to the largest peak for this gas.

The norm factor indicates the sensitivity for the chosen gas at its chosen mass position.

4.4.7 Activating the Interfering Gas Suppression (IGS)

The IGS Mode offers a mode in which interferences between R600a as the refrigerant and Cyclopentane, Isopentane as well as any mixtures of the two will be suppressed.

In this mode, the Ecotec E3000 will automatically differentiate between these three gases and should compensate properly for levels of foaming agents not exceeding 50 g/a with an error of less than 1%.

To enable the IGS mode, choose R600a as the refrigerant and go to the mass menu line. Press enter and toggle through the available masses for R600a until IGS is displayed in the mass line item as illustrated in Fig. 4-11.

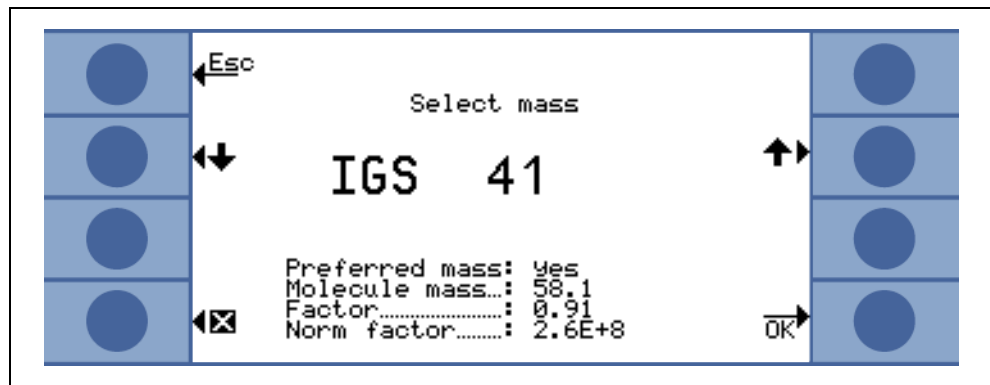

Fig. 4-11 Selecting the IGS mode for R600a

Notice: If the IGS mode is enabled, only one additional gas can be added to the list of gases to be detected. If the IGS mode for R600a is enabled with more than two gases being activated at this time, other gases (starting with the highest gas number of 1 to 4) will be disabled automatically so that only two gases are left activated.

Notice: For R600a in IGS mode and R134a as the second gas please chose mass position 83 for R134a as otherwise there will be interference between the foaming agent and R134a.

Notice: The IGS function should require almost no maintenance. However, if you should notice repeating false alarms when using the IGS mode, an adjustment of the IGS function may be required as described in Chapter 8.2.

4.4.8 Setting up a user-definable gas

For setting-up a user-definable gas please go to the GAS/TRIGGER submenu and press the USER GAS button.

In the opening sub-menu a list of five user definable gases will be displayed. For each gas a user library position number, a user-definable name, a mass position, normalization factor and the molecular mass is listed.

Please go to the gas you would like to set-up and press the EDIT button. In the EDIT USER GAS submenu please go to the appropriate line item you want to modify by the use of the up and down buttons and press the EDIT key.

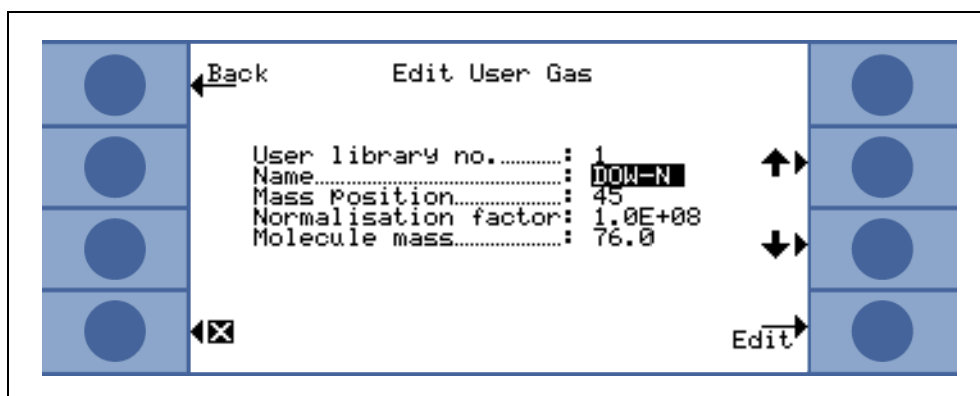

Fig. 4-12 Setting up a user-definable gas

Name

The user gas name is a free text name. When selecting the name line item and pressing edit a 6 digit name can be entered via the alpha-numerical entry keys.

Default value: User 1, User 2, User 3, User 4, User 5

Mass position

The mass position determines the peak position at which the user-definable will be detected. The Ecotec E3000 can determine masses 2 to 200 amu.

Default value: 69

Normalization factor

The normalization factor is a factor that is used to transform the internal sensor current into a leak rate signal. When setting-up a user-definable gas, please try to calibrate the Ecotec E3000 afterwards with an external test leak. If the calibration is successful, do not change the normalization factor. If the calibration process is not successful and the error message "Calibration factor too high" is displayed, please decrease the normalization factor by one decade, e.g. from 1.0E+08 to 1.0E+07. If the error message "Calibration factor too low" is displayed, please increase the normalization factor by one decade, e.g. from 1.0E+08 to 1.0E+09. Repeat this process until the Ecotec E3000 is successfully calibrated.

Molecular mass

For the molecular mass please enter the molecular mass of the gas you want to detect (usually available from data sheet for the gas).

4.5 Settings Sub-menu

In the settings sub-menu several settings which are important for the leak testing procedure can be edited.

4.5.1 Vacuum & Access Menu

In the VACUUM & ACCESS sub-menu setting monitoring functions like the ZERO function, the flow limits setting and the sensitivity check can be edited.

Zero

When pressing the ZERO button the ZERO function will be enabled or disabled. When the ZERO function is enabled the currently detected background level of refrigerant is set to ZERO and only increased levels of refrigerant are displayed. The ZERO level is adjusted automatically on decreasing backgrounds.

If the use of the ZERO function is allowed, the leak rate which is currently being displayed is saved as the "ZERO level" after having operated the ZERO button, i.e. the lower display limit will be displayed (for example, 0.05 g/a). Only values above this ZERO level are indicated so that resolution of the displayed measurement signal is improved.

Notice: It is not possible to reduce the detection limit of the Ecotec E3000 by pressing the ZERO button, only resolution is improved.

Should the background which has been suppressed using the ZERO button change, the ZERO level is updated automatically. This avoids a condition were a leak is not detected because the ZERO level mode has been activated.

The ZERO function may be controlled by the left sniffer button and / or the ZERO button on the main display. The ZERO function may be enabled or disabled for both buttons separately.

Default value:

Sniffer probe: enabled

Main unit: enabled

Zero time

The ZERO function is automatically updated when the background decreases so that negative values will never be displayed, thus avoiding unintended missing of leaks.

The ZERO TIME is the time the leak rate has to be negative in order for the Ecotec E3000 to update the background level.

The ZERO TIME can be set to values between 1.0 and 9.9 s.

Default value: 5.0 s

Flow limits

In this submenu the minimum and maximum gas flow through the capillary is entered.

If the actual gas flow drops below this limit (e.g. if the capillary becomes partially blocked) or exceeds this limit (e.g. if the sniffer line is damaged so that ambient air is sucked in) an alarm is issued.

The closer the LOWER FLOW LIMIT is set to the actual gas flow (160 sccm) the more sensitive the Ecotec E3000 will respond to beginning clogging of the filters and the sniffer line itself.

The closer the UPPER FLOW LIMIT is set to the actual gas flow the more sensitive the Ecotec E3000 will respond to damages to the sniffer line.

The LOWER FLOW LIMIT can be set to values between 0 and 160 sccm.

Default value is 100.

The UPPER FLOW LIMIT can be varied between 160 and 999 with a factory default value of 250.

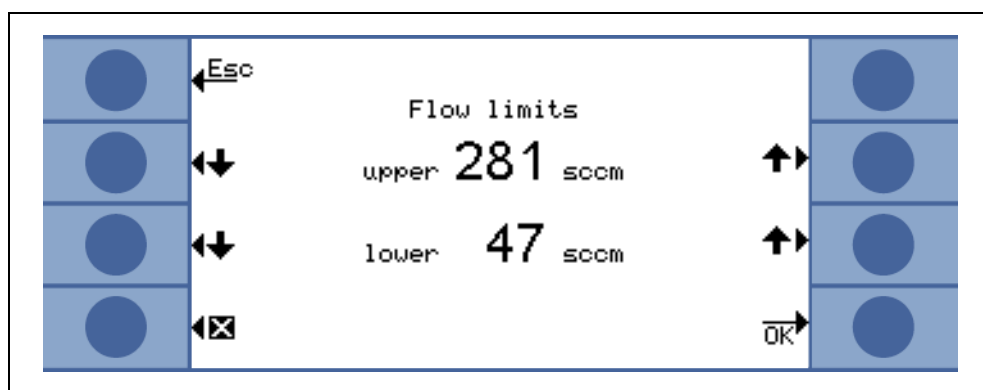

Fig. 4-13 Changing the flow limits of the sniffer line

Notice: The flow through the sniffer line depends on the atmospheric pressure. If operated at high altitude the flow through the sniffer line may drop significantly (approx. 20% per 1000 m [3000ft] altitude). In this case, please adjust the flow limits accordingly.

Sensitivity check

SENSITIVITY CHECK is a monitoring function which will help to ensure that the sensitivity of the Ecotec E3000 will always be sufficient.

In the SENSITIVITY CHECK submenu the sensitivity check can be enabled or disabled. With this setting the entire gas flow from the tip of the sniffer into the sensor is monitored and at the same the software checks the Ecotec E3000 to determine if it in turn determines the correct signal amplitude.

Running of this function ensures that the Ecotec E3000 will not become insensitive without this being noticed by the user.

If sensitivity changes, E30 will be displayed. In this case, please recalibrate the Ecotec E3000 to restore sensitivity (see Section 3.5). The error message will be repeated every 15 seconds until a re-calibration is started.

Notice: It is highly recommended to always keep this function enabled. This function should only be disabled when operating in an Argon-free environment as the Argon signal is used for monitoring.

Default value: enabled.

Cal

In the CALibration submenu an internal calibration can be ENABLED or DISABLED. If the function is set to DISABLED, only a proof function with the built-in ECO-Check reference leak will be possible.

Default value: ENABLED

Change menu PIN

Any changes to the current settings may be password protected. The menu PIN can be changed in the “change menu PIN” submenu.



Fig. 4-14 Setting-up a Menu-PIN for parameter protection

If a new PIN is entered the Ecotec E3000 software will ask to repeat the new PIN to prevent entering errors. Afterwards the menu PIN will be changed to the new value.

Notice: The operator needs to go back up through the main menu for this change to become effective immediately. Otherwise, the new PIN will be activated after 5 minutes.

A menu PIN of “0000” means no password protection, all menus can be freely accessed.

Default setting: 0000

4.5.2 Audio Functions

In the AUDIO sub-menu all settings regarding the different audio alarms of the Ecotec E3000 can be edited.

Beep sound

Beep sounds are sounds that are issued as confirmation of certain functions, e.g. completion of a calibration process. This acknowledgement sounds can be enabled or disabled in the beep sound submenu.

Default value: enabled.

Audio intern

The internal loudspeaker of the main unit can be switched on and off. This will not effect the headphones outlet.

Default value: enabled.

Audio sniffer

The alarm of the loudspeaker in the probe handle can be set to react to exceeding the TRIGGER LEVEL or exceeding the SEARCH LEVEL. It can also be DISABLED.

Default value: TRIGGER LEVEL.

Alarm type

Different types of audio alarm of the main unit speaker can be selected. Options are SETPOINT, PINPOINT, and TRIGGER ALARM

Default value: Trigger Alarm

SETPOINT The frequency of the tone will change when the trigger level is exceeded. Below the trigger level the loudspeaker will remain off.

TRIGGER ALARM /An acoustic alarm with a continuous low tone will sound as soon as the search level is exceeded. An acoustic alarm which consists of two tones sounds as soon as the trigger level is exceeded. Below the search level the loudspeaker will remain off.

If the Ecotec E3000 is set to TRIGGER ALARM as the alarm type an additional button will be shown on the lower right side called TONE 1,2,3. With this button different alarm sounds can be selected for the trigger alarm to clearly distinguish between nearby other Ecotec E3000 leak detectors.

PINPOINT The external loudspeaker is always on. Within the leak rate range of +/- one decade of the trigger level the frequency will change depending on the leak rate. Outside this range the tone will be constantly low or high. This setting is recommended if also leaks which are still below the trigger level need to be pinpointed or if the expected leak rates are within the range of the trigger level.

Default value: Trigger Alarm

Volume

The MINIMUM VOLUME and the currently selected VOLUME for the loudspeaker in the main unit can be edited.

The MINIMUM VOLUME is the lowest level the volume can be set to from the main display and should prevent unintentional turning off of the main unit audio alarms. Both values will also be valid for the headphones outlet.

Both volumes (minimum and current) can be chosen between 0 and 15.

Default value for minimum volume: 2

Default value for the current volume: 2

4.5.3 Display Settings

In the DISPLAY SETTINGS submenu the contrast of the display can be changed, the peak hold function, the gas select mode and the user mode can be edited.

Contrast

In the CONTRAST submenu the contrast of the main unit display can be adjusted. Values between 0 and 99 can be entered. Also the display can be switched to inverted colours.

Default value: not inverted, Level 50

Notice: If by accident the display contrast has been set too high or too low so that it cannot be read off anymore, this can be fixed as follows: Shut off the Ecotec E3000 and switch it back on.

During run-up press menu buttons 3 and 7 constantly until the contrast is back to normal.

This setting is not saved to the EEPROM but needs to be confirmed manually through the contrast menu.

Otherwise the Ecotec E3000 will go back to the out of range setting after the next start-up.

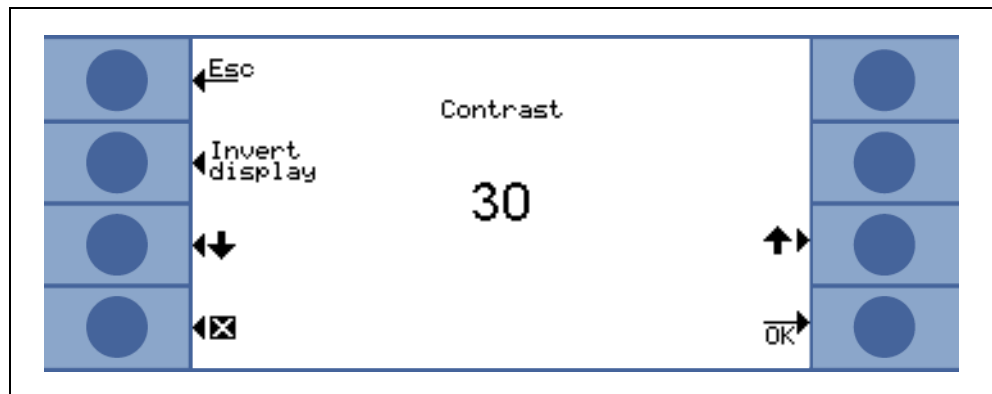

Fig. 4-15 Setting-up the contrast of the main display

Peak hold

The PEAK HOLD function can be enabled or disabled in this submenu.

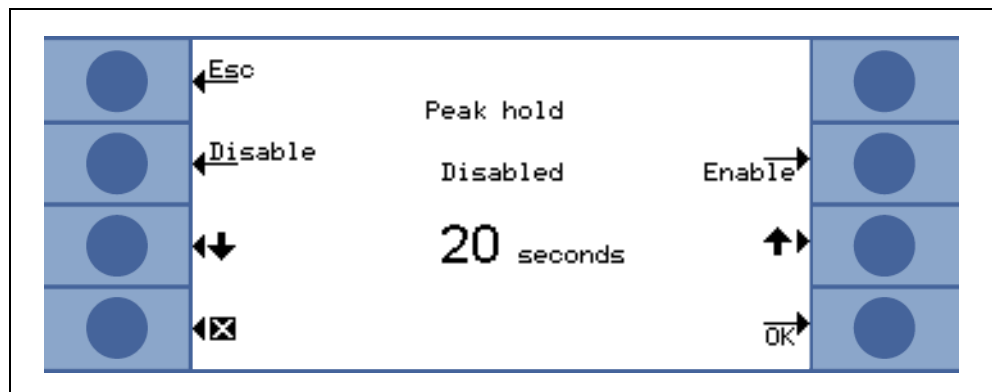

Fig. 4-16 Setting-up the peak hold function

If the PEAK HOLD function is enable the maximum leak rate will be displayed for a preset time in addition to the currently measured value in the main display. The time setting will have no effect if this function is disabled.

Default: disable 5 s.

Gas select

In this submenu the display option for the probe display can be selected. In AUTO mode always the gas with the currently highest leak rate will be indicated on the probe display.

In "MANUAL" mode the gas displayed on the probe display can be manually selected by the right probe button. Repeated use of the right probe button will scroll through the currently active gases.

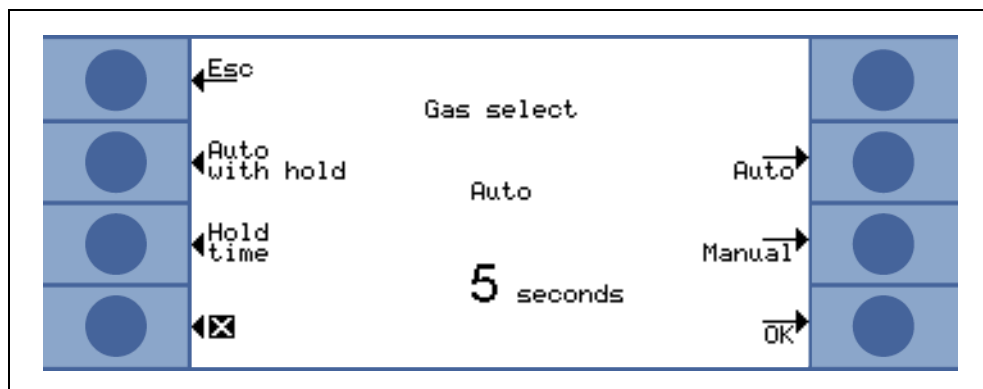

Fig. 4-17 Selecting the "Gas select" Mode

In the "AUTO WITH HOLD" mode also the gas with the currently highest leak rate will be indicated on the probe display. However, this can be overruled by the use of the right probe button.

The Ecotec E3000 will automatically switch back to the automatically selected highest leak rate after the pre-set hold time.

Default mode: auto

The hold time can be selected in steps of 5 secs between 5 and 30 s.

Default value: 5 s

User mode

In this submenu of display settings either the NORMAL or the ADVANCED mode can be selected. In the NORMAL mode only the most relevant information for normal operation will be displayed whereas in the ADVANCED mode additional information for advanced users will become available.

4.5.4 Setting-up / editing an I•Guide Program

When selecting the SETUP PROGRAM button a submenu page will open showing the list of 10 pre-programmable I•Guide programs and their current status (enabled / disabled).

If a program is enabled it will be offered in the list of programs to select from when operating in the I•Guide mode. To change the status of a program use the ENABLE / DISABLE button on the left side of the display.

I•Guide cycle counter

The reset counter button on the right side of the display allows to reset the I•Guide cycle counter manually. The I•Guide cycle counter is not saved on power off and therefore is also automatically reset on each power on / off of the Ecotec E3000.

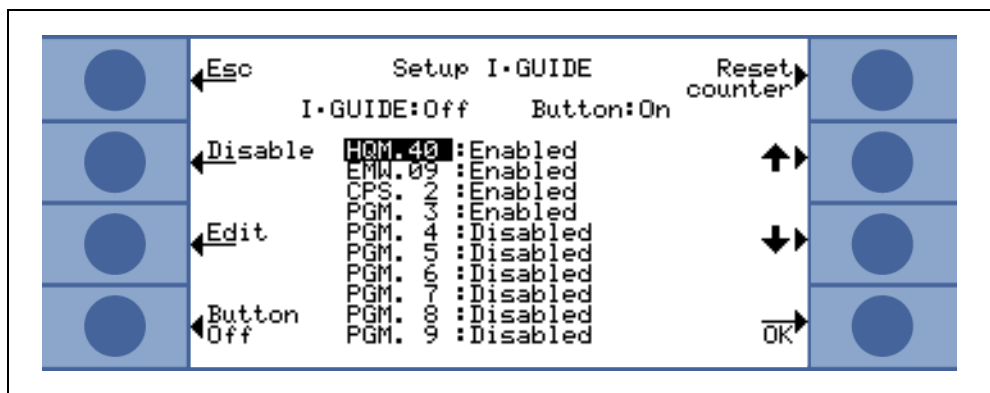

Fig. 4-18 Setting-up the I•Guide Mode

Button

The button function allows to disable the use of the right sniffer probe button which is used for navigating through an I•Guide program cycle. The disabling of the right sniffer probe button is mainly needed for robotic application (where the navigation is controlled via RS232 instead of the sniffer probe button).

Editing an I•Guide program

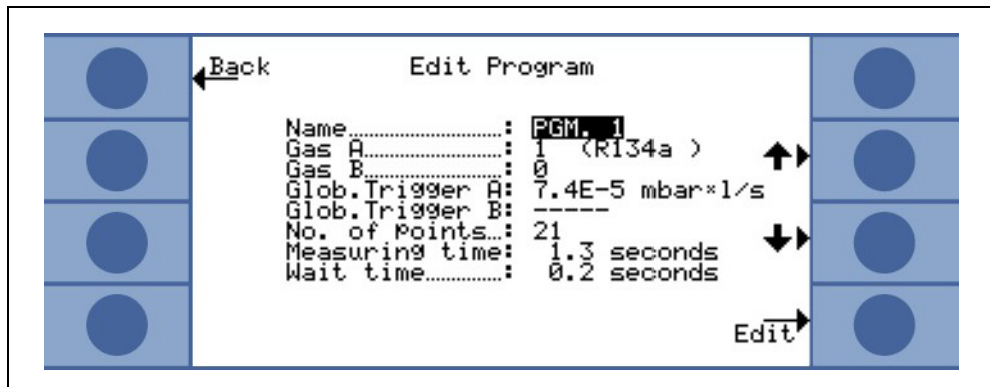

Fig. 4-19 Editing an I•Guide program (one gas selected)

To edit the parameters of a program select the program by scrolling to the corresponding menu line and open the selected program by pressing the "EDIT" button.

In the opening EDIT PROGRAM sub-menu the name of the program and the gas type(s) selected for this program are stated.

One or two gases from the max of four gases which may be setup in the EDIT GAS submenu may be selected.

If only one gas is selected, the other gas will be set to 0.

If two gases are to be used, these must be different gas types (reflected by different gas numbers).

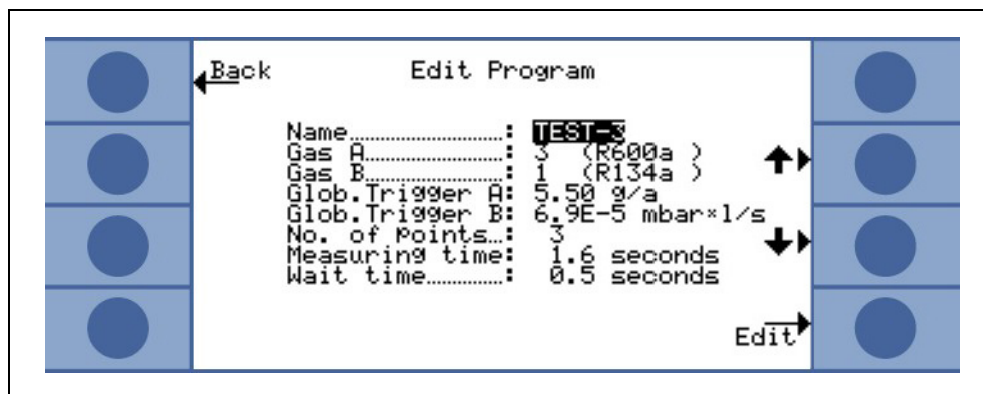

Fig. 4-20 Editing an I•Guide program (two gases selected)

For each of the two gases a summarized global trigger value corresponding to the allowable leak rate for the complete unit under test is stored. If only one gas is selected, the GLOBAL TRIGGER B line item is left blank.

In addition, the number of locations to be leak tested, the minimum measuring time for each location as well as the wait time between two leak tests allowed for moving the sniffer to the next location is stated.

Each parameter can be edited by scrolling to the appropriate line item and selecting the highlighted item by pressing the EDIT button. (If only one gas is selected the GLOBAL TRIGGER B line item will be skipped on scrolling.)

Notice: The I•Guide mode can also be used as a timer signal only. If the number of points is set to 0, the Ecotec E3000 will prompt for the next location to be tested continuously without using the global leak rate function.

Each parameter can be edited by scrolling to the appropriate line item and selecting the highlighted item by pressing the EDIT button.

Name

Each program can be named with a free text, descriptive name up to 6 characters. The name can be edited by highlighting the NAME line and pressing EDIT.

An alphanumerical entry screen will open. Press OK after entering the desired name description.

Gas A / B

For editing the gas type go to the "GAS A" or "GAS B" line item and press "EDIT". Only gases that are listed in the "GAS/TRIGGER" submenu (Gas1 to Gas4) are available for selection. The gas type is stated in plain text in parenthesis. The list of maximum four available gases can be scrolled with the up and down buttons.

Notice: The I•Guide Mode refers to the gases selected in the "GAS/TRIGGER" submenu. If you change a gas in the "GAS" submenu the gas selected for the I•Guide program will automatically change as well.

Global trigger A / B

In the GLOBAL TRIGGER A/B submenu the maximum allowable leak rate for the complete unit under test can be edited. The same ranges as for a single trigger value are allowed. The unit of measurement for the global trigger will be the same as selected for this gas type in the edit gas submenu. If GAS B is not selected (GAS B = 0), the GLOBAL TRIGGER B is not accessible.

Default value: 10 g/a or 0.357 oz/yr (or the equivalent in any other unit of measurement)

No. of points

The number of potential leak locations to be checked can be varied between 0 and 99 and can be edited with the up and down keys.

Default value: 4

Notice: The I•Guide mode can also be used as a timer signal only. If the number of points is set to 0, the Ecotec E3000 will prompt for the next location to be tested continuously without using the global leak rate function.

Notice: The I•Guide mode can also be used to summarize leak rates on demand. If the number of points is set to 99, a results screen with summarized global leak rate will be displayed after the right button has been pressed for 2 s continuously (or after the 98th point automatically).

Measuring time

The MEASURING TIME during which the sniffer tip needs to be hold to the correct location can be programmed to values between 1.0 and 25.0 s. The MEASURING TIME should not be less than the response time of the Ecotec E3000.

We recommend to use the following minimum measuring times:

sniffer line length	Refrigerants	He	H ₂ /Forming gas
3 m	1.0 s	2.2 s	2.7 s
5 m	1.3 s	2.5 s	3.0 s
10 m	2.1 s	3.3 s	3.8 s
15 m	3.3 s	4.5 s	5.0 s

Please use the up and down buttons for editing this parameter.

Default value: 1.0 s

Wait time

The WAIT TIME between two leak checks allowed to move the sniffer to the next potentially leaking location can be varied between 0.1 s and 25.0s in steps of 0.1s . Please use the up and down buttons for editing this parameter.

Default value: 3.0 s

4.5.5 **Miscellaneous Settings**

Language

Different languages can be chosen in which the software can be operated. The current selection includes English, German, Spanish, French, Italian, Portuguese, Japanese (Katakana) and (simplified) Chinese (Mandarine).

Default value: English

Notice: If the Ecotec E3000 has been set to a language that you do not understand, turn off the power and press the second button from the top of the display on both sides simultaneously during run-up.

This will reset the Ecotec E3000 to English as the menu language. This setting is not saved automatically. Please go to the LANGUAGE submenu afterwards and select the appropriate language.

Time & date

In this submenu the internal clock of the Ecotec E3000 can be set. On the first page the date needs to be entered in the format DD.MM.YYYY.

The lower right button (→) opens the second page on which the time in the format HH.MM is entered.

Sniffer light

The intensity of the sniffer light can be varied to the desired level. The intensity can be selected between 1 and 6.

Also the light can be switched on and off via the DISABLE / ENABLE buttons. Any new setting must be confirmed with the OK button.

Default value: on, level 4.

Pressure unit

The pressure unit of all displayed values of the Ecotec E3000 can be set to Pa, Torr, atm or mbar.

Default value: mbar

Leak rate filter

For all normal operation the I•Filter should be selected. I•Filter is an intelligent filtering algorithm that yields the best results with respect to noise level and stability of leak rate values specifically developed for use in the Ecotec E3000 leak detector.

Only in cases where the older Ecotec II model is replaced by an Ecotec E3000 and the Ecotec E3000 is used in a fixed testing system it may be required to stick with the "AUTO" or "LOW" filter that was used in the Ecotec II.

Default: I•Filter

Alarm delay

Under conditions with very unstable background conditions it may be favourable to not issue an alarm immediately but only release an audio alarm if the trigger level has been exceeded for an extended time.

This ALARM DELAY can be entered in 1/10 of a second. Values between 0 and 9.9 sec will be accepted.

Default value: 0.0 sec (i.e. disabled).

Wake up

If you are working in one- or two-shift operation, you may use this function to automatically wake up the Ecotec E3000 from SLEEP mode in the morning to allow for proper warm-up time (please allow for approx. 30 min).

You have to program a time (in hours and minutes, 24 hours) and the Ecotec E3000 will wake up automatically at the pre-programmed time.

A different wake-up time may be programmed for each weekday. If no time is entered, the Ecotec E3000 will not wake-up automatically at all.

Default value: disabled for all weekdays

4.6 Interfaces

In the INTERFACES submenu the CONTROL LOCATION, the RECORDER OUTPUTS, the RS232 PROTOCOL, the PLC INPUTS, the PLC OUTPUTS and the BAUD RATE & END SIGN can be edited.

4.6.1 Control location

The CONTROL LOCATION can be "LOCAL", "RS232" or "LOCAL AND RS232".

In LOCAL mode the RS232 interface can only be used to read data, but not for control purposes.

In RS232 mode, the Ecotec E3000 is controlled solely via the interface and the display can only be used for viewing data.

In LOCAL AND RS232 mode the Ecotec E3000 can be controlled via the interface but also by input from the main display.

Default setting: local and RS232

Notice: Even with the control location set to RS232 some parameter may still be able to be changed through the main units software menus. Please lock these by the menu PIN to prevent unintended changes.

4.6.2 Recorder outputs

For the recorder output the "RECORDER OUTPUT SCALE" and the "RECORDER OUTPUT GAS" can be selected.

The RECORDER OUTPUT SCALE can either be linear or logarithmic. The output signal is provided through channel 1 (pin 1 of the I/O port).

Which of the 4 gases is indicated here is defined through the menu line RECORDER OUTPUT GAS.

Recorder output scale

LIN The voltage range spans from 0 V to 10 V.
The leak rate which is output is normalized with respect to the trigger level for the corresponding gas. The trigger level will correspond to an output of 1 V. Higher and smaller leak rates may be output as a voltage deviating by a corresponding factor with reference to the trigger level.

Example:

The trigger level of the corresponding gas has been set to 3 g/a.

leak rate = 0.3 g/a → $U_{\text{analog}} = 0.1\text{V}$

leak rate = 3 g/a → $U_{\text{analog}} = 1.0\text{V}$

leak rate = 10 g/a → $U_{\text{analog}} = 3.3\text{V}$

Voltages over 1V indicate that the trigger level has been exceeded.

LOG The voltage range is 0 - 10 V. Beginning at 1V, each leak rate decade is spread over 2 volts, i.e.:

- 1...3V: 1st decade
- 3...5V: 2nd decade
- 5...7V: 3rd decade
- 7...9V: 4th decade

Thus a leak rate range of 4 decades will be output by way of an analogue signal. The four decades are set through the value and the unit of measurement for the trigger level.

The software of the Ecotec E3000 will set the output voltage in such a manner that the trigger level itself will always be set within the second decade (i.e. within the range of 3 to 5 Volts).

Examples:

Trigger level	Output voltage (1 to 9V) will correspond to
3 g/a	0.1 to 100 g/a
0.2 oz/yr	0.01 to 10 oz/yr
5×10^{-4} mbar l/s	1×10^{-5} to 1×10^{-1} mbar l/s

The following table has been provided to clarify the way in which the output voltage represents the leak rate.

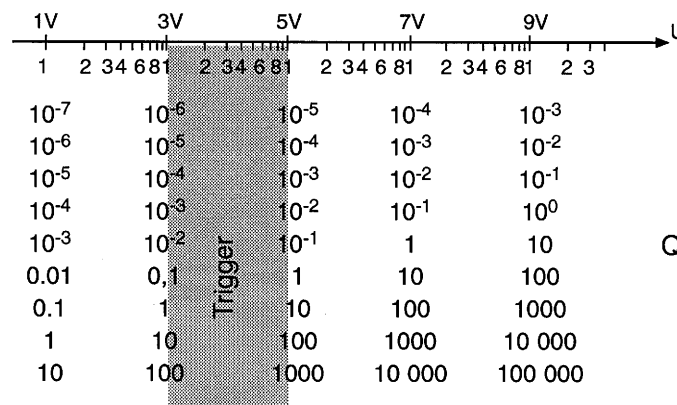

Further examples:

For a trigger level of 2 g/a a leak rate of 8 g/a is represented by an output voltage of 4.81 V:

$$U = 3 + 2 \cdot \log 8$$

(The factor of 2 is used since one decade is spread over 2 Volts. The summand of 3 is used because the trigger level will always be within the range of 3 to 5 V).

Trigger	Leak rate	Output voltage
0.1 oz/yr	1.5 oz/yr	→ 5.35V
3 g/a	20 g/a	→ 5.60V
	50 g/a	→ 6.39V
5 x 10 ⁻⁴ mbar l/s	8 x 10 ⁻⁵ mbar l/s	→ 2.806V
	6 x 10 ⁻³ mbar l/s	→ 6.556V

Default setting: logarithmic

Recorder output gas

Here one gas from the four gases is defined which will be output as the analog signal through channel 1. This is selected through the PLUS/MINUS keys.

Selecting one of the numbers 1 ... 4 outputs the corresponding gas 1 ... 4 on the display as the analog signal.

Channel 2 (pin 14 of the I/O port) indicates the gas number by way of a voltage, i.e. a voltage between 1 V ... 4 V will be present accordingly.

When selecting AUTO the leak rate which has the highest value with reference to the corresponding trigger level is output as the analog signal.

Correspondingly the voltage in channel 2 will differ accordingly.

In the modes "ERROR", "NOT READY TO MEASURE" and "SLEEP" a voltage of U = 10 V will be output through channels 1 and 2.

Default setting: AUTO

4.6.3 RS232 Protocol

The RS232 protocol can be set to "ASCII", "DIAGNOSTICS", "PRINTER AUTO" or "PRINTER MANUAL".

The ASCII PROTOCOL is a protocol similar to the SCPI, a standard protocol widely used for measuring equipment.

For details on this protocol please refer to the Interface Description (kins22e1).

Diagnostics

The DIAGNOSTICS protocol is a binary protocol used for analysis in quality control and trouble shooting during manufacturing and service.

Default setting: ASCII

Printer Manual

The PRINTER MANUAL protocol allows to send leak rates on pressing the right sniffer probe button. One line will be send for each currently enabled gas.

Notice: When in any of the two printer modes, no ASCII commands must be sent to the Ecotec E3000 as this will interrupt the printer mode.

<i>Format</i>				
Date	Time	Gas name	Leak rate	Unit
<i>Example</i>				
03.05.2005	12:31	R134a	2.34	g/a
03.05.2005	12:31	R600a	<0.1	g/a

When set to I·Guide mode the PRINTER MANUAL mode is without function.

Printer Auto

In PRINTER AUTO the leak rate will be sent any time the set trigger level is exceeded. At the time the signal drops below the trigger level the maximum detected leak rate will be sent only for the gas(es) that exceeded the trigger.

<i>Format</i>				
Date	Time	Gas name	Leak rate	Unit
<i>Example</i>				
03.05.2005	12:31	R134a	2.34	g/a

When set to I·Guide mode the leak rate results will be sent after each test point together with the test point number.

After the test cycle has been completed, the summarized global leak rate will be sent.

Example:

Point no.	Date	Time	Leak rate	Unit
Point 01			0.1	g/a
Point 02			0.1	g/a

Point no.	Date	Time	Leak rate	Unit
Point 03			12.2	g/a
Point 04			0.1	g/a
Global	13.04.2007	11:57:03	12.5	ga

4.6.4 Baud rate & end sign

The BAUD RATE can be set to values between 1200 and 19200. Default setting: 9600.
 The END SIGN can be set to Carriage Return (CR), Line Feed (LF) or to CR+LF.
 Default setting: CR+LF.

4.6.5 Select PLC Inputs

In the SELECT PLC INPUTS submenu the user can select which pin on the I/O port (suitable for PLC input) represents which command. The default setting is as follows:

Pin	Command	Pin	Command
7	Sleep	13	Gas b
8	Not used	20	Zero
9	Gas a	25	Gas select

To change these settings select the appropriate pin with the UP and DOWN arrows on the left side of the display and afterwards select the desired command from the list of commands with the UP and DOWN buttons on the right side of the display. Press OK to save your settings. A screen with all selected settings will be displayed for your reference. Confirm with OK again.

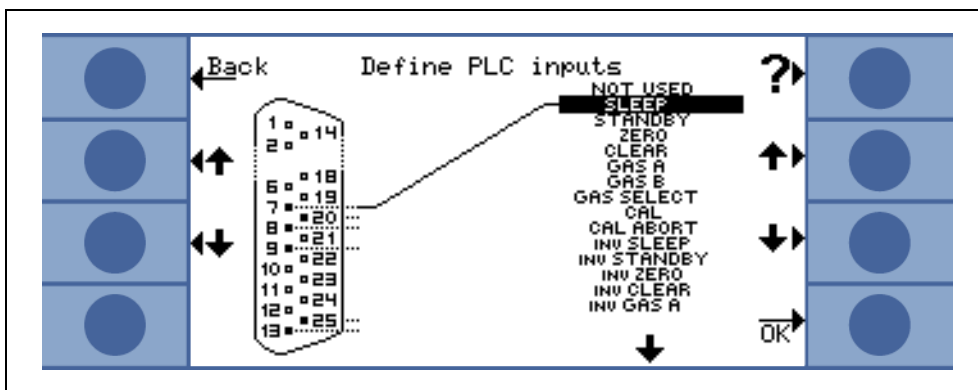

Fig. 4-21 Defining PLC-Inputs from list of possible commands

4.6.6 Select PLC Outputs

In the SELECT PLC OUTPUTs submenu the user can select which pin on the I/O port (suitable for PLC output) represents which command. There are four PLC outputs and two relays outputs available. The default setting is as follows:

PLC outputs

Pin	Command	Pin	Command
4	Ready	16	Leak
5	not used	17	Error

Relays outputs

Pin	Type of contact	Relay Output (default)
10	Currentless closed (NC)	Leak
22	Common	
23	Currentless opend (NO)	
24	Currentless closed (NC)	Ready
11	Common	
12	Currentless opend (NO)	

To change these settings select the appropriate pin with the UP and DOWN arrows on the left side of the display and afterwards select the desired command from the list of commands with the UP and DOWN buttons on the right side of the display. Press OK to save your settings. A screen with all selected settings will be displayed for your reference. Confirm with OK again.

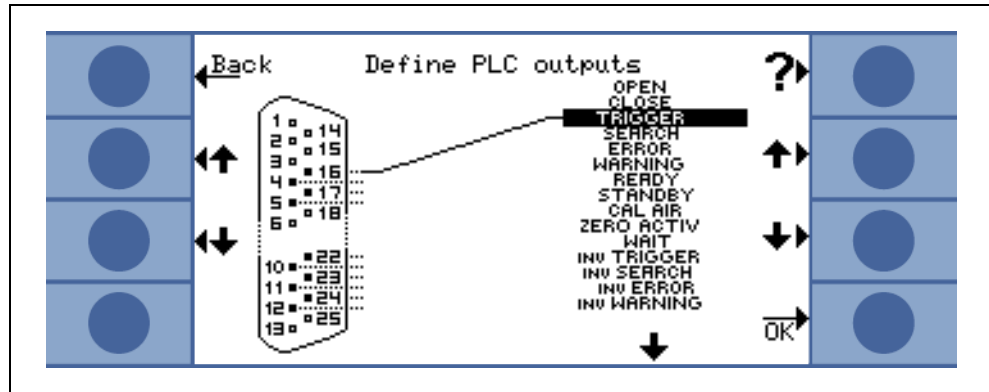

Fig. 4-22 Defining PLC outputs

4.6.7 ECO-Check (only available in *ADVANCED Mode*)

In this submenu the ECO-Check reference leak can be disabled completely so that for Ecotec E3000 leak detectors without an ECO-Check onboard the Ecotec E3000 does not check for the electrical connection with the reference leak anymore and no error message is issued.

Default value: Enable

4.7 The Info Menu

The INFO MENU lists all internal data that may be useful for any trouble-shooting of the Ecotec E3000. The info menu consists of 8 pages. On each page the upper left button "BACK" allows to leave the info menu, the lower left button allows to go back one page whereas the lower right button allows to go to the next page. The page number is displayed in the upper right corner.

Menu item	Format	Description
Page 1: General Data		
Foreline pressure	mbar	Pressure at inlet to mass spectrometer
Flow	sccm	Flow through sniffer line
Total pressure	mbar	Pressure in mass spectrometer
Time since power on	Min	
Operation hours	h	
Serial number	9000 XXX XXXX	
Software version	x.xx.xx	
Circuit temperature	°C / °F	Temperature of main board
TSP temperature	°C / °F	Temperature of mass spectrometer
Test leak temperature	°C / °F	Temperature of ECO-Check reference leak
Page 2: Turbo molecular pump data		
State	On/off	
Current error code		
Rotation speed	Hz	
Current	A	
Voltage	V	
Power	W	
Operation hours TMP	H	Operation hours of TMP
Operation hours TC	H	Operation hours of frequency converter for TMP

Menu item	Format	Description
Run-up time	S	
Software version	xxxxxx	
Page 3: Transpector data		
Configuration		
Box version	x.xx	
Control SW version	x.xx	
Measure SW version	x.xx	
Filament des./act.	A / B	Desired filament / active filament
Power on time	H	
Emission on time A	H	
Emission on time B	H	
TSP temperature	°C / °F	Temperature of mass spectrometer
Argon Position	+ / - x.xx	
Page 4: ECO-Check data		
Gas	Rxxx	Gas type of internal leak
Leak rate nom / at T	g/a / g/a	
Version / Checksum	x.x / Hex Code	Software Version with Checksum
Serial no.	9000 XXX XXXX	
Serial no. reservoir	9000 XXX XXXX	
Date of bottling	DD.MM.YYYY	
Expiry date	DD.MM.YYYY	
Gain / Offset		
Test leak temperature	°C / °F	
State		
Page 5: Sniffer data		

Menu item	Format	Description
Type	SL3000 / system	
Software version	x.x	
Length	3 m / 5 m / 10 m / 15 m	
Serial no.	9000 XXX XXXX	
Switch left		
Switch right		
Backlight	Green / red	
Bar graph		
Flow at calibration	sccm	
Page 6: I/O Port data		
Recorder A	V	
Recorder B	V	
Sleep	low / high	
Zero	low / high	
Gas a/b/select	low / low / low high / high / high	
Input reserved	low / high	
Leak/Ready/Error	low / low / low high / high / high	
Relais Leak	low / high	
Relais Ready	low / high	
Output reserved	low / high	
Page 7: Analog data		
AIN3 Sniffer length	V	
AIN4 +5V II Leak	V	
AIN5 +24V III ext	V	
AIN6 +5V I Sniffer	V	
AIN8 -15V MC50	V	

Menu item	Format	Description
AIN9 +15V MC50	V	
AIN10 +24V MC50	V	
AIN11 +24V I TSP	V	
AIN12 +24V II TMP	V	
Page 8: Analog data		
AIN0	V	
AIN0 offset	V	
Foreline pressure	mbar	
AIN1	V	
Flow	sccm	
AIN2	V	
Page 9: RS232 Info		
Ecotec E3000 → sniffer	ASCII string	Command sent from main unit to sniffer
Sniffer → Ecotec E3000	ASCII string	Command sent from sniffer to main unit
Host → Ecotec E3000	ASCII string	Command sent from host to Ecotec E3000
Ecotec E3000 → Host	ASCII string	Command sent from Ecotec E3000 to host

4.8 History & Maintenance

In the HISTORY & MAINTENANCE menu page historical data that has been collected during the operation of the Ecotec E3000 can be viewed. This includes error lists, a listing of the calibration history and a service list.

The available functions depend on the current user mode, in „STANDARD“ the following menu is to be seen:

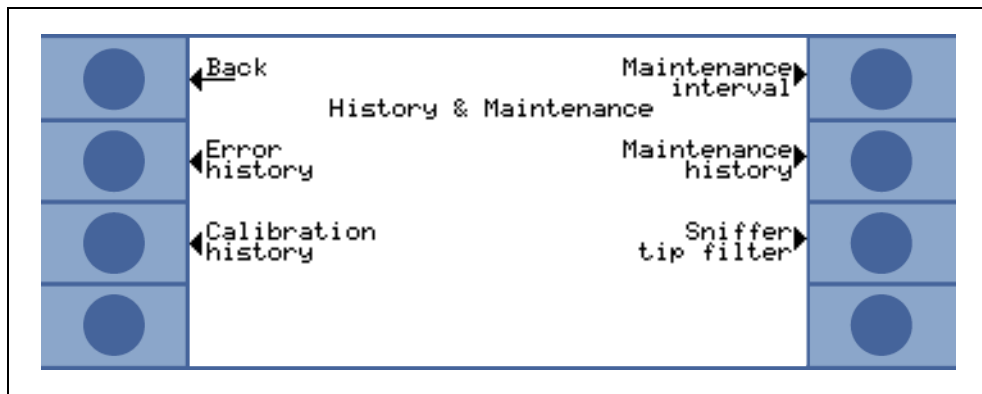

Fig. 4-23 The HISTORY & MAINTENANCE menu page (user mode „STANDARD“)

The menu page changes in user mode „ADVANCED“:

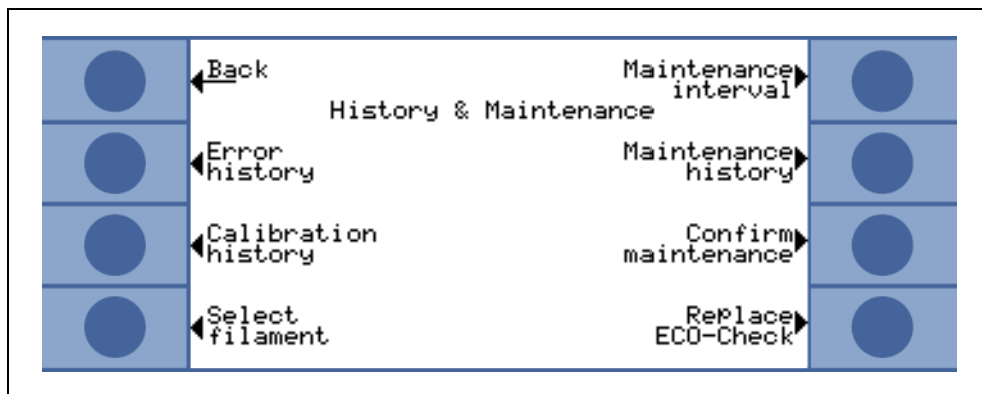

Fig. 4-24 The HISTORY & MAINTENANCE menu page (user mode „ADVANCED“)

View error list

In the ERROR LIST all errors (and warnings) that have occurred during the operation of the Ecotec E3000 are summarized.
 In the list the DATE and TIME when the error occurred is stated followed by error or warning number (E X being errors and W X being warnings) with a short description of the error or warning.

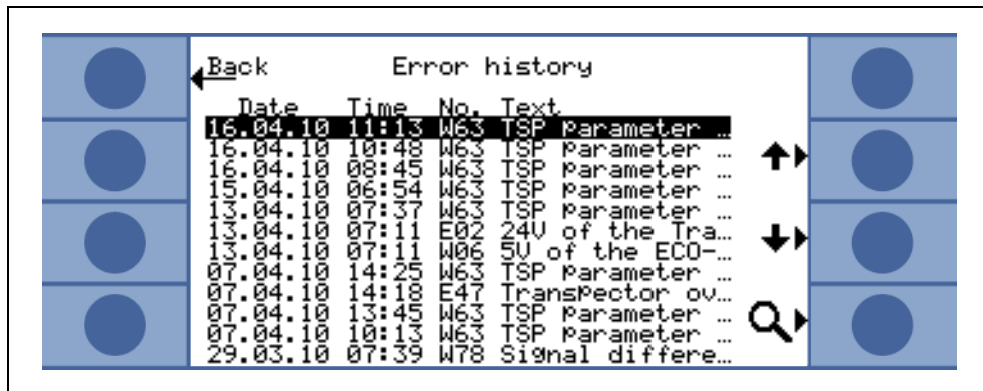

Fig. 4-25 Example of an Ecotec E3000 ERROR HISTORY LIST

The full error message or warning may be displayed when scrolling to the appropriate line item and pressing the magnifying glass button.

Calibration history

In this listing all calibrations that were conducted during the operation of the Ecotec E3000 are collected.
 The DATE & TIME the calibration was performed, the TYPE of calibration (internal or external), which GAS number (in gas of external calibration) as well as the calibration factor are listed.
 Each line may be viewed by pressing the VIEW (magnifying glass icon) button.

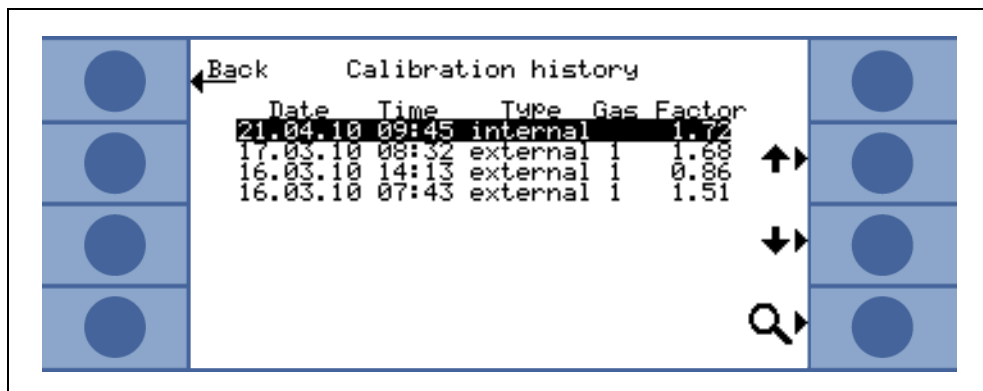

Fig. 4-26 Example of an Ecotec E3000 CAL IB RATION HISTORY

If you view an external calibration the following information will be displayed:

- The calibration mode (internal or external)
- The gas that was calibrated (gas number, mass position, gas name in case of external calibration / gas numbers) in case of internal calibration)

- The date and time of calibration
- The number of operation hours at time of calibration
- The calibration factor
- The peak position (as deviation from mass position)
- The flow through the sniffer line at the time of calibration
- The filament that was in use at the time of calibration (A/B)
- The size of the test leak used (external test leak for external calibration and ECO-check for internal calibration)
- The argon current at the time of calibration
- The current for the gas to be calibrated with test leak and background signal (only in ADVANCED mode)

Maintenance interval

In the MAINTENANCE INTERVAL sub-menu the number of operating hours for the main Ecotec E3000 in total, the operating hours of the turbo molecular pump and of the Transpector are listed.

Also all necessary maintenance tasks are displayed and the number of operating hours / days until they are due for maintenance the next time are stated.

When the number of operating hours have expired a warning will be issued as a reminder to perform the appropriate task.

The reminders are issued for the TMP, the fore pump (diaphragm pump) and the air filter of the main unit.

Please also refer to Section 4.1 (Error Messages and Warnings)!

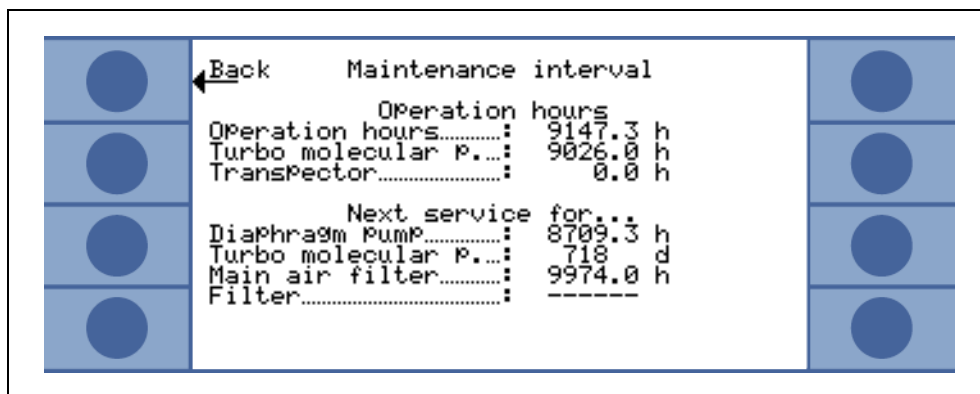

Fig. 4-27 Example of a MAINTENANCE INTERVAL menu page

Maintenance history

In the MAINTENANCE HISTORY list all maintenance tasks performed are listed. The date and the time the maintenance tasks were performed, the number of operation hours the unit had worked at the time when the maintenance task was performed and the type of maintenance that was conducted are listed. Details about each maintenance task may be view when highlighting the appropriate line item and press the VIEW button.

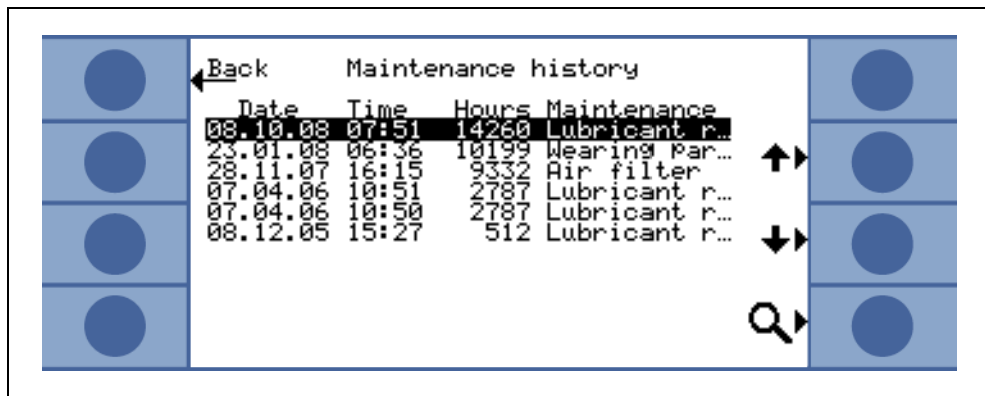

Fig. 4-28 Example of a MAINTENANCE HISTORY list

Confirm maintenance
(in ADVANCED user mode only)

In this submenu maintenance tasks can be confirmed and the date and the number of operation hours at which the maintenance task was performed is saved in the software.

Maintenance must be confirmed for the lubricant reservoir, the air filter in the main unit and sniffer tip filter.

The maintenance intervals for the lubricant reservoir and main unit air filter are fix and a reminder for the different maintenance tasks will be issued by the software after the appropriate maintenance interval has expired.

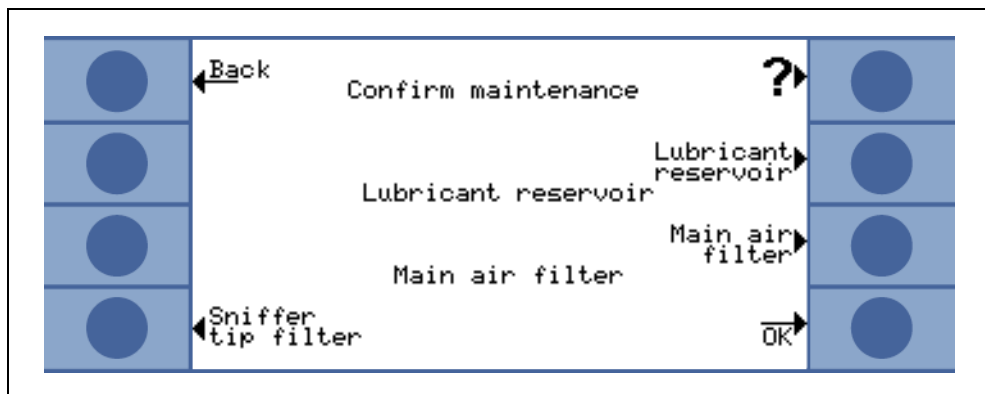

Fig. 4-29 Confirming maintenance work performed

If in ADVANCED user mode the SNIFFER TIP FILTER submenu is part of the CONFIRM MAINTENANCE submenu. For details on this feature see the paragraph above.

Notice: Maintenance of the diaphragm pump can only be confirmed in the (password protected) service menu by trained personnel.

Replace ECO-Check
(in ADVANCED user mode only)

When replacing the gas reservoir of the ECO-Check reference leak, the new serial number of the replacement gas reservoir as well as a code containing the calibration data of the new reservoir needs to be entered in this submenu. For details on how to replace the gas reservoir of the ECO-Check reference leak please refer to Section 8.8.

Notice: This menu item will only be available as long as the ECO-Check is enabled in the SETTINGS / INTERFACE / ECO-CHECK submenu.

Sniffer tip filter
(in STANDARD user mode only)

The maintenance interval for the sniffer tip filter depends on the operating environment and may be set to values between 10 and 999 hours. If set to 0 the reminder message for the sniffer tip filter will be disabled.

Default value: 100 hours

For details on how to perform the maintenance tasks see Chapter 8, Maintenance.



Fig. 4-30 Setting the maintenance interval for the sniffer tip filter and confirming its replacement

Select Filament

In this submenu you can manually select which Transpector™ filament to use.

Default: A

4.9 Monitoring Sensitivity

It is highly recommended to always keep the SENSITIVITY CHECK function enabled. This function should only be disabled when operating in argon-free environment as the argon signal is used for monitoring.

For details on this function see Section 4.5.1 (“Sensitivity Check”)

If sensitivity changes, ERROR CODE E30 will be displayed. In this case, please recalibrate the Ecotec E3000 to restore sensitivity (see Section 3.5).

The error code will be displayed every 15 seconds until a recalibration is started.

5 Ecotec E3000 Messages

During leak detection operations the LCD display will indicate information which supports the operator in running the Ecotec E3000. Besides measurement data, also current equipment conditions, operating hints as well as warnings and error messages can be displayed.

5.1 Error Messages and Warnings

The Ecotec E3000 is equipped with comprehensive self-diagnostic functions. When a faulty condition is sensed by the control board, this condition is indicated to the operator via the LCD display as far as possible.

Errors

Errors are events which force an interruption of the measurements in progress and which the Ecotec E3000 is not capable of rectifying on its own. Errors are indicated in plain text together with an error number.

The Ecotec E3000 remains in the error status. After the fault cause has been removed the error can be acknowledged by pressing the **RESTART** button. The Ecotec E3000 then returns to the measurement mode.

Warnings

Warnings are issued if an abnormal condition is detected that may cause increased inaccuracies of measurements but will not interrupt measuring completely.

Notice: In case of enquiries please keep the serial number and the software version number of the Ecotec E3000 at hand.

The following abbreviations are used in the listing + error messages below:

TMP	turbo molecular pump
TC	TMP controller
TSP	Transpector NV-RAM: non-volatile RAM

In the following table all possible error messages and the recommendations stated in the display in case of this error are listed. If no recommendation is given, please call your nearest INFICON service representative (see Section 1.2.1).

Error no.	Plain text message	Possible reason	Recommendation
E1	24V of the MC50 too low	Fuse F1 on the motherboard has blown	Replace fuse F1 on motherboard*
E2	24V of sensor heating too low	Fuse F2 on the motherboard has blown	Replace fuse F2 on motherboard*
E3	24V II too low	Fuse F3 on the motherboard blown	Replace fuse F3 on motherboard*
W4	24V of the OPTION socket too low	Fuse F4 on the motherboard has blown	Replace fuse F4 on motherboard*
W5	5V of the sniffer is too low	Fuse F5 on the motherboard has blown	Replace fuse F5 on motherboard*
W6	5V of the internal Leak too low	ECO-Check electronics defective	Replace ECO-Check reference leak or call nearest INFICON service representative!
E7	-15V of the MC50 is too low	Motherboard defective	Call nearest INFICON service representative!
E8	15V of the MC50 is too low	Motherboard defective	Call nearest INFICON service representative!
W12	TMP frequency not reached during start-up!		Frequency converter faulty Turbo molecular pump faulty If W12 is issued in a high humidity environment or after extended shutdown times, please shut off the Ecotec E3000 and turn it back on. If W12 occurs again, please let the Ecotec E3000 sit in idle (with the pumps running) for about 30 min.
W14	Filter service interval expired!	Time since last filter change longer than set interval	Please replace sniffer tip filter! (see Section 8.6)
W16	TMP service interval expired!	More than three years since last TMP maintenance	Please replace lubricant reservoir! (see Section 8.4)
W17	Fore pump service interval expired!	> 10,000 operating hours since last fore pump service	Replace membrane of diaphragm pump!*
W18	Air filter service interval expired!	> 10,000 operating hours since last main air filter service	Clean or replace main air filter! See Section 7.2
E20	Temperature at electronic unit is too high (>60°)	Ambient temperature too high	Cool down environment, place Ecotec E3000 in cooler area.
		Ventilation failure	Check if fans on both side of main unit are running (check for air flow through inlets on both side of main unit housing)
		Air filter dirty	Clean or replace main air filter See Section 7.2
E22	TMP frequency too low!	Frequency converter faulty Turbo molecular pump faulty	Call nearest INFICON service representative!
E23	TMP frequency too high!	Frequency converter faulty Turbo molecular pump faulty	Call nearest INFICON service representative!
W24	24V for the ext. control unit too low	<u>For Ecotec E3000RC only:</u> Fuse on the RC-driver board blown	Replace fuse on RC-driver board!*

Error no.	Plain text message	Possible reason	Recommendation
E25	Remove sniffer from CAL port	Sniffer inserted in calibration port during start-up or sniffer needs to be removed during internal calibration process	Remove sniffer from calibration port of ECO-Check!
		Light barrier of ECO-Check dirty	Blow out with fresh air and / or clean with cotton swab!
W28	Real time clock reset! Please enter date and time!	CPU-board has been replaced	Please enter date and time! See Section 4.4.5
		Battery on CPU-board faulty	Replace CPU-board*
E30	Sensitivity too low	Argon signal too low	Check if fresh air is provided to sniffer line Please recalibrate the Ecotec E3000
W31	Factor K1 out of range!	Interfering gases other than cyclopentane or isopentane (e.g. alcohols) detected	Recalibrate IGS! (see Section 8.2)
W34	Flow has changed!	Flow has changed by more than 30% since last calibration (warning will disappear if change drops below 20% again).	Recalibrate the Ecotec E3000 (See Section 3.5) or replace sniffer line filters!
W35	Flow through capillary is too low	Actual flow is lower than lower flow limits (In LOW FLOW mode) Filter in sniffer line blocked Capillary blocked Filter in main unit blocked Lower flow limit setting too high	Replace sniffer tip filter See Section 8.6 Replace filters of sniffer line and recalibrate! (felt filter, capillary filter and / or filter pad in SL3000XL sniffer line and recalibrate) See Section 8.6 or Replace probe cable* Replace internal filter* Decrease lower flow limit See Section 4.4.1
E36	Capillary broken (>2 s)	Actual flow is higher than upper flow limits for more than 2 s Capillary broken or leaky Upper pressure limit setting too low	Replace sniffer line and recalibrate! Or: Replace probe cable* and recalibrate! Increase upper flow limit (see Section 4.5.1) Press OK to restart the Ecotec E3000
E37	Capillary broken (>10 s)	Actual flow is higher than upper flow limits for more than 10 s, emission will be switched off to protect filaments Capillary broken or leaky Upper pressure limit setting too low	Replace sniffer line and recalibrate! Or: Replace probe cable* and recalibrate! Increase upper flow limit (see Section 4.5.1)

Error no.	Plain text message	Possible reason	Recommendation
E38	Capillary broken (>60 s)	Actual flow is higher than upper flow limits for more than 60 s, pumps will be switched off to protect filaments Capillary broken or leaky Upper pressure limit setting too low	Replace sniffer line and recalibrate! Or: Replace probe cable* and recalibrate! Increase upper flow limit (see Section 4.5.1) Press OK to restart the Ecotec E3000
E39	No emission!	Start emission failed on both filaments during start-up!	After extended shutdown times this error may occur during the first 10 min after power on Please acknowledge the error and startup again automatically. If problem persists, call nearest INFICON service representative.
E40	No emission!	Emission failed during operation	After extended shutdown times this error may occur during the first 10 min after power on. Please acknowledge the error and startup again automatically. If problem persists, call nearest INFICON service representative.
E41	No communication with Transpector!	Software cannot establish communication with Transpector	Check cable connection between Transpector and CPU-board!* Call nearest INFICON service representative!
E42	Transpector temperature > 70°C or < 0°C!	Air filter dirty Ambient temperature too high Ambient temperature too low	Replace main air filter (see Section 8.3.) Check ambient temperature
E43	Transpector limit exceeded!	Refer to Transpector internal data	Call nearest INFICON service representative!
E44	Transpector communication error!	Refer to Transpector internal data	Call nearest INFICON service representative!
E45	Transpector hardware error!	Refer to Transpector internal data	Call nearest INFICON service representative!
E46	Transpector hardware warning!	Refer to Transpector internal data	Call nearest INFICON service representative!
E47	Transpector over-pressure!	After extended shutdown times this error may occur during the first 10 min after power on. This may also occur if sniffer line has been disconnected for extended times!	Please acknowledge the error and the Ecotec E3000 will startup again automatically. Reconnect sniffer line and acknowledge error, Ecotec E3000 will startup again automatically.
E48	Transpector no emission!	After extended shutdown times this error may occur during the first 10 min after power on. This may also occur if sniffer line has been disconnected for extended times!	Please acknowledge the error and the Ecotec E3000 will startup again automatically. Reconnect sniffer line and acknowledge error, Ecotec 3000 will startup again automatically.

Error no.	Plain text message	Possible reason	Recommendation
W49	No emission with first filament!	Start emission failed with first filament !	Switch to 4.8
E50	Unkown TC-Error	Failure of the turbo electronic drive	Call nearest INFICON service representative!
E51	No communication with turbo controller	Software cannot establish communication with controller of TMP	Call nearest INFICON service representative!
W59	EEPROM parameter queue overflow!	May occur if software "update" to older version is performed	Restart the Ecotec 3000, if problem persists, call nearest INFICON service representative!
W60	All EEPROM parameter lost! Please check your settings!	New EEPROM has been installed, EEPROM on motherboard is virgin	All settings in software menu are reset to default! Please enter your settings again!
		If message comes up repeatedly during start-up, EEPROM on motherboard is faulty	Replace EEPROM*
W61	EEPROM parameter initialized!	Software update performed and new parameters have been introduced Newly introduced parameters are listed below warning	Acknowledge warning
		If message comes up repeatedly during start-up, EEPROM on motherboard is faulty	Replace EEPROM*
W62	EEPROM parameter lost!	Parameter has been modified during software update and reset to default value Affected parameters are listed below warning	Check setting of modified parameters in corresponding software menu and set to desired value!
		If message comes up repeatedly during start-up, EEPROM on motherboard is faulty	Replace EEPROM*
W63	TSP parameter mismatch!	TSP replaced or SW updated Non volatile memory of TSP faulty EEPROM on motherboard faulty	Please check data and restore!*
W64	There are outstanding warnings!	Acknowledged but still valid warnings will be repeated every 2 hrs or on each new power on	Please double-check the warnings!
W66	ECO-Check virgin!	New ECO-Check reference leak installed in main unit	Please enter serial number and code. See Section 4.7 , Replace ECO-Check
W67	ECO-Check will be expired at DD.MM.YYYY	Warning for pending expiration will be issued starting three months before actual expiration	Please order new ECO-Check gas reservoir! (cat. no. 521-010)
W68	ECO-Check expired!	ECO-Check has been used for more than 1 year or has been manufactured more than 2 years ago.	Please replace ECO-Check gas reservoir! See Section 8.8
W70	All EEPROM parameter of ECO-Check lost!	EEPROM in ECO-Check is empty or faulty	Replace ECO-Check!

Error no.	Plain text message	Possible reason	Recommendation
W71	No communication with ECO-Check!	No or defective electrical connection between ECO-Check and main unit	Check connection of ECO-Check with main unit If problem persists, call nearest INFICON service representative!
		ECO-Check not installed in main unit	Install ECO-Check!
		No ECO-Check available	Disable ECO-Check in software menu
W72	No communication with sniffer!	No or defective electrical connection between sniffer line and main unit	Check connection of sniffer line with main unit (disconnect and reconnect, if possible, try different sniffer line). If problem persists, call nearest INFICON service
E73	Wrong sniffer line!	SL3000XL (for Ecotec E3000XL) connected accidentally!	Connect correct sniffer line!
W77	Calibration factor has changed!	<u>During proof function only:</u> Calibration detected to have changed by more than 15% since last calibration	Please recalibrate the Ecotec E3000!
W78	Signal difference between calibrated leak and air too small!	Calibrated leak too small / empty during calibration or proof	Check leak rate of test leak or use leak with higher leak rate
		Background too high during calibration	Check helium background by disabling the ZERO function (keep ZERO button pressed for more than 2 sec), provide fresh air to clean up background
		Not enough time expired for air signal to stabilized (acknowledged too early)	Repeat calibration, allow sufficient time for air signal to stabilize!
W79	Factor out of range!	Invalid factor determined during IGS calibration	Repeat IGS calibration! (see Section 8.2) If problem persists, call nearest INFICON service representative!
W80	Switched to other filament!	Ecotec E3000 was switched to other filament without recalibration	Please recalibrate the Ecotec E3000!
W81	Calibration factor too low!	Calibration factor determined to be < 0.1 during internal calibration or > 0.01 during external calibration	
		Leak rate of test leak is incorrect (especially during external calibration)	Check correct setting of test leak value! (see Section 3.5.3)
W82	Calibration factor too high!	Calibration factor during calibration determined to be > 10 or > 99.9 during external calibration	
		Leak rate of test leak is incorrect (especially during external calibration)	Check correct setting of test leak value! (see Section 3.5.3)
		Test leak not sniffed properly / not long enough	Repeat calibration, sniff test leak properly and for sufficient time
E83	Baseline Transpector not found	Severe Transpector problem	Call nearest INFICON service representative!

Error no.	Plain text message	Possible reason	Recommendation
E84	Test leak signal too small	Issued during calibration Test leak faulty Sensor sensitivity too low Insufficient gas flow to sensor, flow divider clogged	Recalibrate with different test leak Call nearest INFICON service representative! Replace flow divider*
W85	Problem with peakfind	<u>Only during calibration:</u> Problem with peak finding of Transpector	Perform proof function (see Section 3.5.1)! If proof is okay, acknowledge, but schedule service visit! If proof function is not okay, call nearest INFICON service representative!
W86	Internal Calibration not possible	Not in measure mode when calibration is attempted	Wait until Ecotec E3000 enters measurement mode
W87	Not supported gas in ECO-Check!	Occurs only during internal calibration or proof function EEPROM in ECO-Check not programmed	Replace complete ECO-Check
E90	E001: TMP excess rotation speed	Rotation speed of TMP too high	Call nearest INFICON service representative!
E91	E002: Power pack unit error	Power pack output voltage faulty	Call nearest INFICON service representative!
E92	E006: Start-up time error	Free running of the turbo pump restricted Fore-vacuum pressure too high	Call nearest INFICON service representative!
E93	E008: Connection TC and pump	Connection between TC and pump faulty	Call nearest INFICON service representative!
E94	E015: Error in TC controller	Reset the controller with mains ON/ OFF with the pump at standstill (f=0Hz)*	Call nearest INFICON service representative!
E95	E021: Incorrect pump identification resistance	Incorrect pump identification resistance	Call nearest INFICON service representative!
E96	E025: Error in temperature monitoring TC	Reset the controller with mains ON/ OFF with the pump at standstill (f=0Hz)	Call nearest INFICON service representative!
E97	E026: Error of the temperature sensor inside the TC	Reset the controller with mains ON/ OFF with the pump at standstill (f=0Hz)	Call nearest INFICON service representative!
E98	E037: Error in the motor stages or control	Error in the motor stages or control	Call nearest INFICON service representative!
E99	F007: Mains power failure Operations voltage has failed	Mains power failure operations voltage has failed	Call nearest INFICON service representative!

* only to be performed by INFICON-authorized service personnel

6 Detecting Specific Gases

6.1 R134a / Cyclopentane

When detecting R134a in presence of cyclopentane (foaming agent) R134a should be detected on the alternative mass position 83 to avoid false alarms due to cross sensitivity with the cyclopentane.

Please refer to section 4.4.6 for how to select an alternative mass position.

6.2 R134a / R245fa

When detecting R134a in presence of R245fa (foaming agent) R134a should be detected on the alternative mass position 83 to avoid false alarms due to cross sensitivity with the R245fa.

Please refer to section 4.4.6 for how to select an alternative mass position.

6.3 R600a / Cyclopentane / Isopentane

When detecting R600a in the presence of cyclopentane and / or isopentane (foaming agent), R600a should be set to "IGS" as the mass position.

Please refer to Section 4.4.7 for how to activate the IGS mode.

6.4 Helium

When detecting helium the response time of the Ecotec E3000 will be longer than for refrigerants. Please allow for the following minimum measuring times when detecting helium:

Sniffer line	Min. measuring time
3 m	2.2 s
5 m	2.5 s
10 m	3.3 s
15 m	4.5 s

The smallest detectable leak rate for helium will be $1 * 10^{-6}$ mbarl/s (higher than for refrigerants).

When detecting helium, a PRO-Check reference leak (cat. no. 521-001) may be connected to the Ecotec E3000 remotely and used for internal calibration of helium.

When working with helium (diluted), the leak rate may also be displayed as gas equivalent leak rate. See Section 4.4.3 for details.

6.5 Hydrogen / Forming gas

When detecting hydrogen (as contained in forming gas) the response time of the Ecotec E3000 will be longer than for refrigerants.

Please allow for the following minimum measuring times when detecting hydrogen / forming gas.

When working with hydrogen (forming gas), the leak rate may also be displayed as gas equivalent leak rate. See Section 4.4.3 for details.

Sniffer line	Min. measuring time
3 m	2.7 s
5 m	3.0 s
10 m	3.8 s
15 m	5.0 s

When detecting hydrogen the warm-up time before the first calibration should be extended to 1 hour.

The smallest detectable leak rate for hydrogen will be $1 \cdot 10^{-6}$ mbarl/s (higher than for refrigerants).

When detecting hydrogen / forming gas, a ECO-Check reference leak (cat. no. 521-001) may be connected to the Ecotec E3000 remotely and used for internal calibration of hydrogen (forming gas).

6.6 Methan

Notice: The setting for methane is commonly used for the detection of leaks of natural gas which mainly consists of methane.

Methane cannot be calibrated with the built-in ECO-Check reference leak as methane can only be detected on mass 15 (which is outside the range of 40 to 105 which is allowed for internal calibration).

A test leak with a leak rate of > 14 g/a is required for external calibration of the Ecotec E3000.

An external test leak "TL4-6 for methane" is available from INFICON as part no. 12249 for this purpose.

7 Equipment Connections

The Ecotec E3000 is equipped with three electrical control connectors. The electrical connections (head phone, I/O port and RS232) are located on the rear of the Ecotec E3000 directly next to the socket for the mains cable.

Technical Handbook

7.1 I/O Port (Control Inputs and Outputs)

Warning

For all contacts of the I/O Port a maximum voltage of 60 V DC or 25 V AC must not be exceeded or reached to ground or ground equipment conductors. According to the type of in- or outputs lower voltages had to be accepted. For this, please refer to the information given in the responding chapters.

Through this connection some functions of the Ecotec E3000 can be controlled externally or measurement data or the status of the Ecotec E3000 may be communicated to external equipment.

Through relay change over contacts the trigger levels as well as the operating mode (Ready) of the Ecotec E3000 may be monitored.

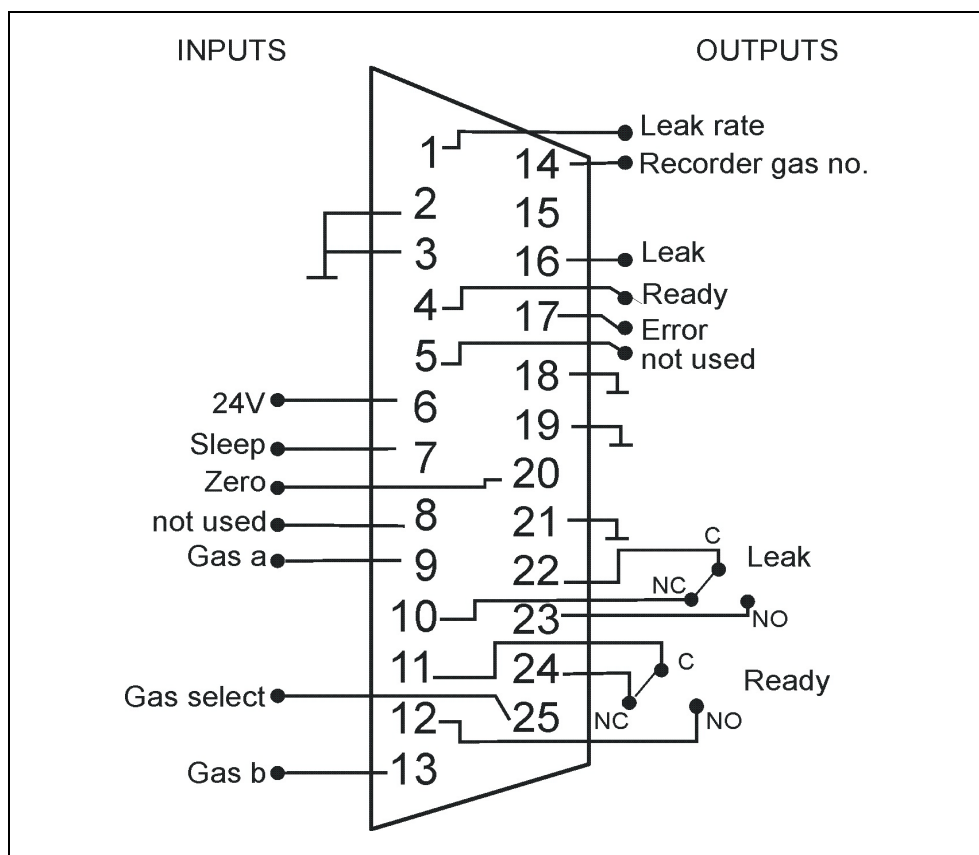

Fig. 7-1 Default Pin Assignment

(1206)

kina22e chapter 7.fm

7.1.1 Ground connectors

Pin 2, 3, 18, 19 and 21 are ground connectors of the control voltages.

7.1.2 24V Output

Pin 6 is a +24 V common output for supplying the PLC inputs and outputs, internally protected with fuse F4.

7.1.3 PLC Inputs

These inputs can be used to control the Ecotec E3000 via a programmable logic control (PLC).



Caution
Permissible maximum input voltage 28 V.

Technical data

24V nominal input
Low level: 0 ...7 V
High level: 13 ... 28 V

Pin assignment (default)

Pin	Default Command
7	Sleep
8	Not used
9	Gas a
13	Gas b
20	Zero
25	Gas select

All PLC inputs can be defined by the user from a list of commands. The commands can be selected in the SETTINGS / INTERFACES / SELECT PLC INPUTS submenu. For details on this submenu please refer to Section .

Sleep

Change from LOW to HIGH to activate SLEEP function.
Change from HIGH to LOW to deactivate SLEEP function (wake up).

Gas select, gas a, gas b

Through the control inputs GAS (pin 9, 13 and 25 of the 25 way Sub-D connector) it is possible to select a gas loaded in the active gas memory (one gas out of four). The Ecotec E3000 will then operate in the single gas mode.

With an edge triggered signal from LOW to HIGH at Pin 25, the selected gas at Pin 13 and 9 becomes valid.

Pin 25	Pin 13	Pin 9	Function
0	x	x	Gas selecting disabled
1	0	0	1 st gas is selected
1	0	1	2 nd gas is selected
1	1	0	3 rd gas is selected
1	1	1	4 th gas is selected

7.1.4 PLC Outputs

These outputs can be used to monitor the Ecotec E3000 via a programmable logic control (PLC).

PLC Outputs are designed as an „Open Collector Output“ or a relay output. Please refer to the example given below for an open collector output „Error“.

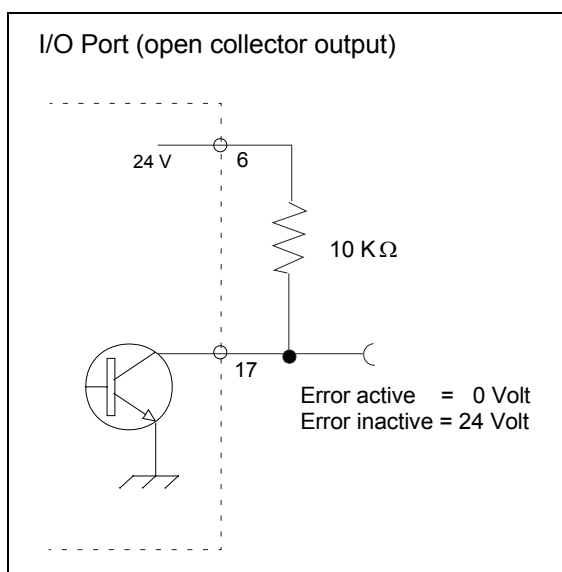

Fig. 7-2 Circuit for open collector output "Error"

Technical data



Caution

Permissible max. voltage and current for open collector outputs are: 28 V; 50 mA.

Open collector output
Active = low

Pin assignment (default)

Pin	Default Command
4	Ready
5	not used
16	Leak
17	Error

All PLC outputs can be defined by the user from a list of commands. The commands can be selected in the SETTINGS / INTERFACES / SELECT PLC OUTPUTS submenu. For details on this submenu please refer to Section 4.6.6.

Ready

Signal is LOW as long as the Ecotec E3000 is ready for measurements.

Leak

Signal is LOW if the preset trigger level is exceeded

Error

Signal is LOW if a warning or error message is active.

7.1.4.1 Relay outputs

Technical data



Caution
Maximum load rating is 60 V DC / 25 V AC and 1 A per relay (resistive load).

Relay
Active = Normally open contact (NO) closed

Pin assignment (default)

Pin	Type of contact	Relay Output (default)
10	Currentless closed (NC)	Leak
22	Common	
23	Currentless open(NO)	
24	Currentless closed (NC)	Ready
11	Common	
12	Currentless open (NO)	

All PLC outputs can be defined by the user from a list of commands. The commands can be selected in the **SETTINGS / INTERFACES / SELECT PLC OUTPUTS** submenu. For details on this submenu please refer to Section [4.6.6](#).

Leak

If the preset trigger level is exceeded, relay contact NO will close and the relay contact NC will open respectively.

Ready

As long as the Ecotec E3000 is ready for measurements, the relay contact NO is closed and the relay contact NC is open respectively..

7.1.4.2 Recorder Outputs

Technical data

Analogue output
0 ... 10 V
max. 1mA

Pin assignment

Pin	Command
1	Leak rate, in linear or logarithmic scale
14	Selected gas number

For details please refer to section [4.6.2 \(Recorder outputs\)](#).

7.1.5 How to perform a calibration

An external calibration may be performed via the PLC inputs and outputs. For this purpose, one of the inputs needs to be configured to "CAL", another needs to be set to "CAL AIR" (for how to select PLC inputs see section 4.6.4). The external calibration is always performed for the enabled gas with the highest gas no. The test leak rate used is the test leak rate which has been used for the last external calibration performed.

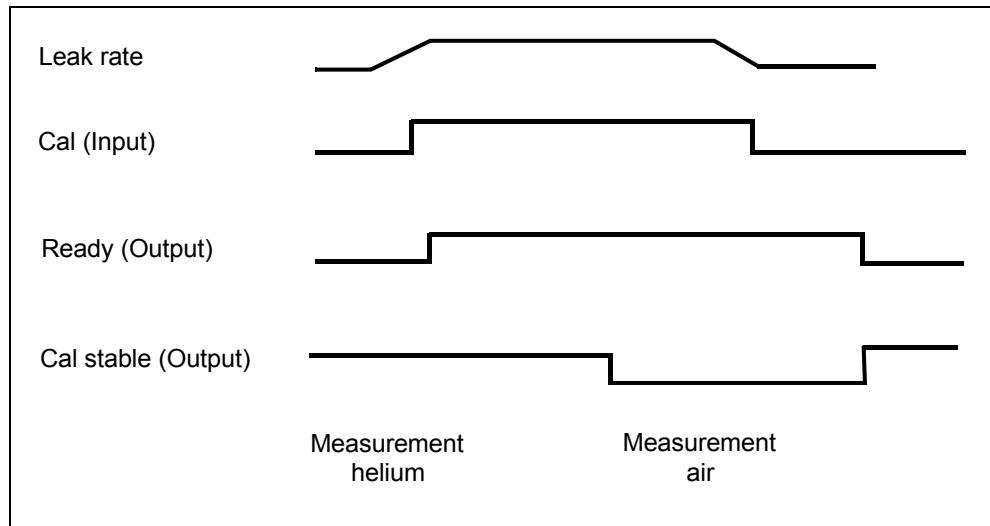

Fig. 7-3

A calibration process is started by setting the CALIBRATION input to HIGH after the sniffer probe tip has been placed in front of a test leak. The READY signal will go to HIGH after the calibration process has started.

Notice: If a calibration is started within the first 20 min after power on a warning is issued. The ERROR output signal will go to LOW and the READY signal will go to HIGH (not ready). In this case, a calibration will not be started until the CLEAR ERROR input signal is set to HIGH (calibration will be started afterwards). Alternatively the calibration may be aborted by setting the CALIBRATION ABORT input signal to HIGH.

When the calibration process has been started the Ecotec E3000 sets the CALIBRATION STABLE output signal to LOW after the signal had enough time to stabilize. The sniffer probe tip then needs to be moved away from the test leak and the CALIBRATION input needs to be set back to LOW afterwards.

The CALIBRATION STABLE output signal stays LOW and is set back to HIGH when the background signal also had enough time to stabilize. At this time the calibration will be completed, the results of the calibration process will be shown on the main display for 3 seconds. After that the main display will go back into measurement mode. The READY output signal will go back to LOW at that time.

In case of an error during calibration, the READY output signal will remain HIGH until the error is erased by the CLEAR ERROR input signal. If ABORT is sent during a calibration before the last edge of the CALIBRATION signal, the calibration process will be aborted.

7.2 *RS232 interface*

The RS232 interface can be used for external control of the Ecotec E3000 but also for simple export of data describing testing results.

For how to set-up the RS232 interface please refer to Section [4.6](#).

For a detailed description of the RS232 interface and its commands please refer to the “Ecotec E3000 Interface Description” (kins26e1)

8 Maintenance



Warning

For all maintenance on the Ecotec E3000, the main power must be disconnected first.

8.1 Maintenance schedule

Required tools

- 2 screw drivers, size 2
- 1 ring spanner wrench, 19 mm (delivered with Ecotec E3000)
- 8 mm hexagonal screw driver (delivered with Ecotec E3000).

Required maintenance	Sub Assembly	Material Description	Part no.	Operation hours		Repair level
				2000	24.000	
Check sinter filter and replace if necessary	Sniffer tip	Sinter Filter for Sniffertip SL3xx, SL3000-x (5 pcs.)	200 03 500	X		I
Replace if W35 „Flow too Low“	Sniffer tip	Felt for Capillary Filter SL3xx, SL3000-x (50pcs.)	200 001 116			I
Check internal filter and replace if necessary	Main Unit	Internal Filter (6 pcs.)	200 03 679		X	II
Turbo pump SplitFlow 50	Main Unit	Operating Fluid Reservoir	200 003 801		1, 2	II
		Bearings				III
Replace diaphragm	Diaphragm Pump MVP015	Wearing parts kit for diaphragm pump	200 03 504		X	III
Clean or replace the air filter at the bottom of the chassis	Main Unit	Air Filter ECOTEC E3000 (104x15 mm, 5 pcs.)	200 001 552		X	I
Replace filament (only on failure)	Main Unit	Spare Cathode for Transpector	200 001 545			III
Replace gas reservoir after 2 years	ECO-Check	Replacement gas reservoir	531-010		1, 3	

Key for Maintenance Schedule:

- I Repair level I Customer
- II Repair level II Customer with technical training from INFICON
- III Repair level III INFICON service engineer

1 To be replaced every 3 years.

2 Date printed on package is latest installation date.

3 Maximum shelf life: 1 year.

8.2 Adjusting the IGS function

(only in ADVANCED user mode)

If you are using the IGS function for suppressing false alarms from Cyclopentane or Isopentane as foaming agent in combination with R600a as the refrigerant, this function may need an adjustment (calibration) for the two interfering gases Cyclopentane and Isopentane if you observe an increasing number of false alarms.

For performing this specific adjustment procedure, the "Calibration kit for IGS Mode" (cat.-No. 531-003) is needed. The kit consists of two simply gas leaks for Cyclopentane and Isopentane.

Notice: For performing the adjustment routine, the IGS mode needs to be enabled. For details on how to enable the IGS mode see Section 3.6.3.7.

To start the adjustment routine, in measurement mode press the CAL button on the right side of the display (like starting an external calibration).

In the opening submenu, you will find an "adjust IGS" button on the left side of the display.

The Ecotec E3000 will ask to sniff air first and will then ask for the two interfering gases to be provided to the sniffer tip. If no gas is provided to the sniffer line, the message "no gas" will be displayed.

Notice: The Ecotec E3000 should detect which gas is currently provided to the sniffer line automatically. In cases, where the wrong gas is detected the gas type will start to blink. In this case, please verify that you are really providing the correct gas.

A results screen will be displayed at the end of the adjustment routine. Please confirm the results with "ok".

8.3 Exchanging the air filter



Caution

The air filter should be checked for contamination at least every 6 months and should be definitely exchanged after 2 years.



Warning

Before exchanging the filter, the Ecotec E3000 must be disconnected from power.

To exchange the air filter, place the Ecotec E3000 on its front-side or position it on the edge of a sturdy bench.

If placing it on the edge of a bench, please pay attention to its center of gravity. If placing it on its front-side, please remove the sniffer line and the built-in ECO-Check first.

Notice: To prevent scratching of the front-cover, it is recommended to use a soft base.

- 1 The fastener for the air filter is on the bottom of the Ecotec E3000.



Fig. 8-1 Fastener for the air filter on the bottom of the Ecotec E3000

- 2 Screw out the fastener screw.
- 3 Extract the air filter.



Fig. 8-2 Dismounting of the air filter

- 4 Depending on the contamination the air filter should be cleaned or replaced as necessary.
- 5 Slide in new (cleaned) air filter until fully in contact with dead stop.

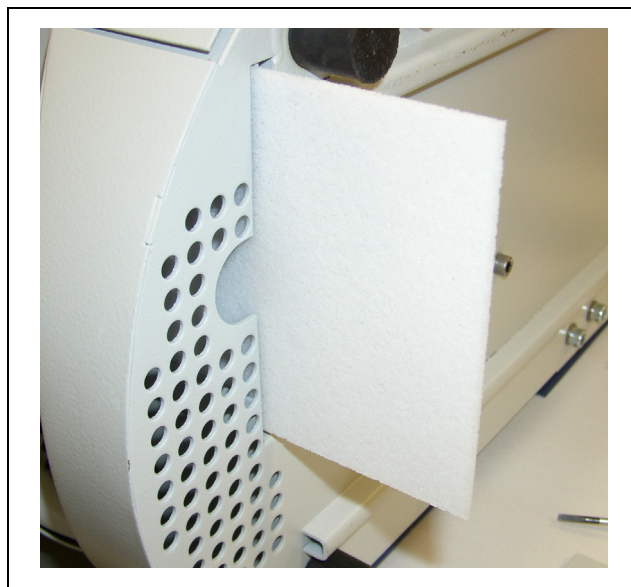

Fig. 8-3 Inserting the air filter

- 6 Close air filter fastener.
- 7 From the main menu go to HISTORY & MAINTENANCE / CONFIRM MAINTENANCE and confirm with the appropriate button on the right side of the display that the air filter has been replaced / cleaned. The actual date and time as well as the actual number of operating hours will be saved and a reminder to perform this maintenance task again will be issued after another 10,000 operating hours.

Notice: The Ecotec E3000 must be set to ADVANCED mode for confirming maintenance tasks.

8.4 Replacing the Operation Fluid Reservoir

Under normal operating conditions the operation fluid reservoir needs to be exchanged at least once a year. Under extreme stress or dirty environment, please contact your INFICON Service representative for special recommendations.

Notice: The operation fluid reservoir has a limited shelf life. Please order only when needed.



Warning

Before exchanging the operation fluid reservoir the Ecotec E3000 must be disconnected from power.



Caution

The operation fluid reservoir may contain toxic substances from the pumped media. Please dispose of operation fluid reservoir as required by local regulations. A Safety Data sheet for the operation fluid is available on request.

- 1 Switch off the Ecotec E3000 and wait at least 5 minutes until the turbo molecular pump has reached atmospheric pressure and has cooled down.
- 2 To exchange the operation fluid reservoir, place the Ecotec E3000 on its front-side or position it on the edge of a sturdy bench.
If placing it on the edge of a bench, please pay attention to its center of gravity. If placing it on its front-side, please remove the sniffer line and the built-in ECO-Check first.
To prevent scratching of the front-cover, it is recommended to use a soft base.
- 3 Open bottom lid with 19 mm ring spanner wrench and lift out operation fluid reservoir using two small screw drivers (see [Fig. 8-6](#)).

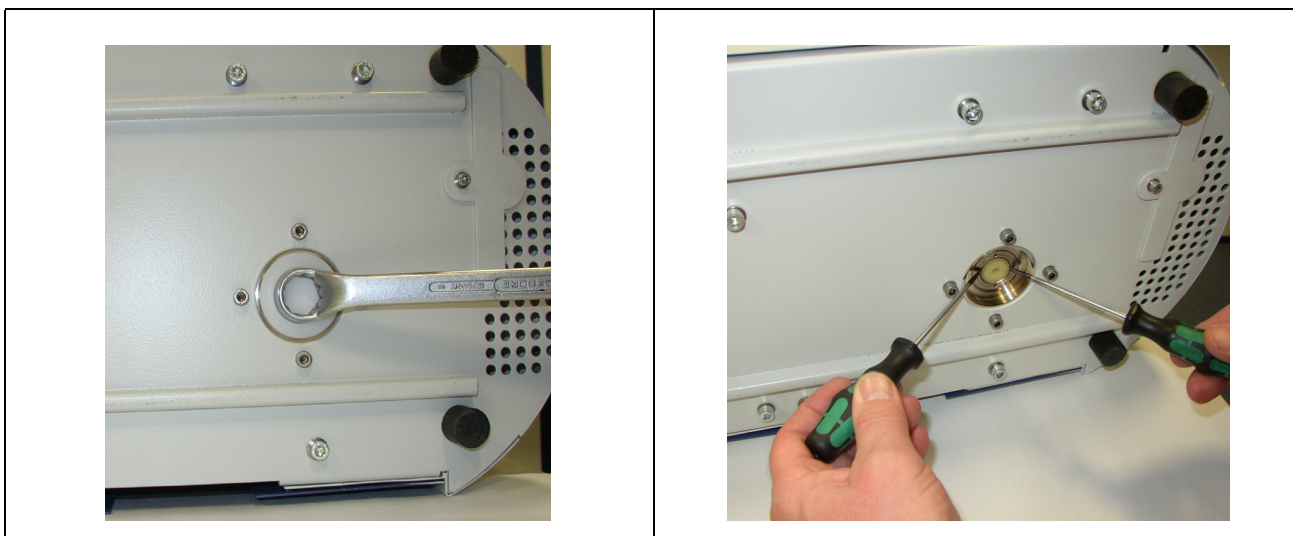

Fig. 8-4 Screw out the end cover

Lift out the operation fluid reservoir

4 Using tweezers, pull out Porex rods (8 pieces)

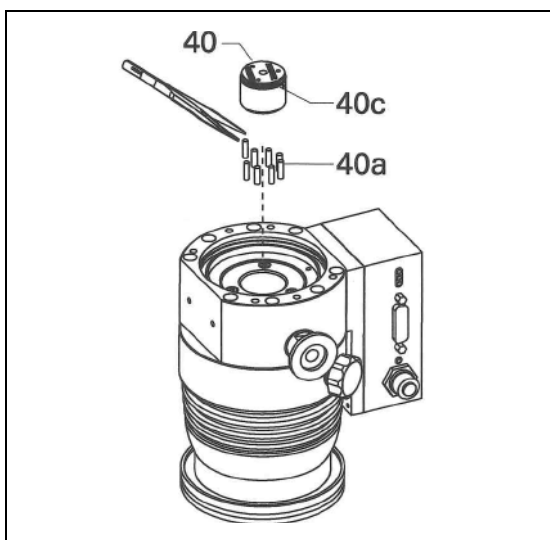

Fig. 8-5 Removing the operation fluid reservoir

Fig. 8-5	
Pos.	Description
40	Operation Fluid Reservoir
40a	Porex rod

5 Using tweezers, insert Porex rods (8 pieces)

- 6 Insert new operation fluid reservoir into the pump up to the O-Ring (see Fig. 8-6).

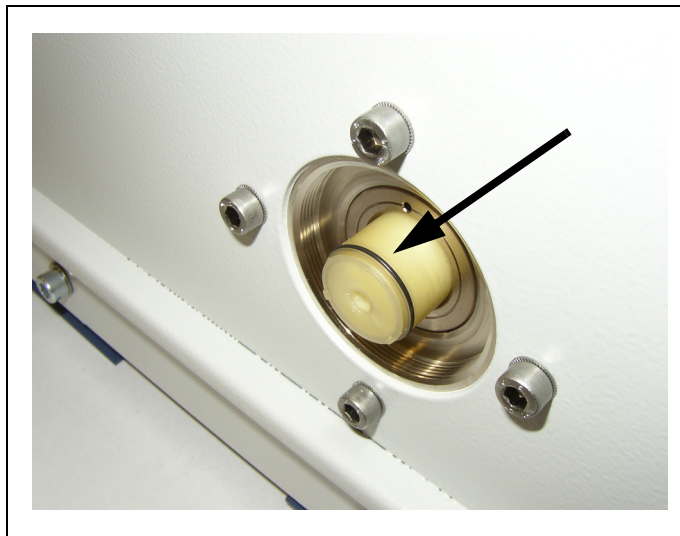

Fig. 8-6 O-Ring of operation fluid reservoir



Caution

Do not completely push in the operation fluid reservoir. The operation fluid reservoir is correctly positioned by the cover after screwing it in.

- 7 Re-assemble bottom lid. Make sure that the O-ring remains in the correct position, as otherwise large leaks can occur.

Notice: The bottom lid will align the operation fluid reservoir to the correct axial position.

- 8 From the main menu go to HISTORY & MAINTENANCE / CONFIRM MAINTENANCE and confirm with the appropriate button on the right side of the display that the operation fluid reservoir has been replaced / cleaned. The actual date and time as well as the actual number of operating hours will be saved and a reminder for maintenance will be issued again after 3 years.

Notice: The Ecotec E3000 must be set to ADVANCED mode for confirming maintenance tasks.

8.5 Exchanging the mains fuses



Warning

Before exchanging the fuses you must disconnect the mains cord.
Only fuses of the specified type and rating are to be used as replacements.

Use a screw driver to fold out the lid of the mains socket from the right (the mains switch is not affected by this).

The fuses can be removed by pulling out the drawers which are marked by the arrows. On re-inserting these, make sure that the arrows point upwards.

The two fuses must be replaced by two fuses of the same rating. The required mains fuses are available as cat.-no. 200 000 914.

After having exchanged the fuse(s) firmly reclose the lid of the mains socket.

Re-connect the mains cord to the Ecotec E3000 and switch on the Ecotec E3000.

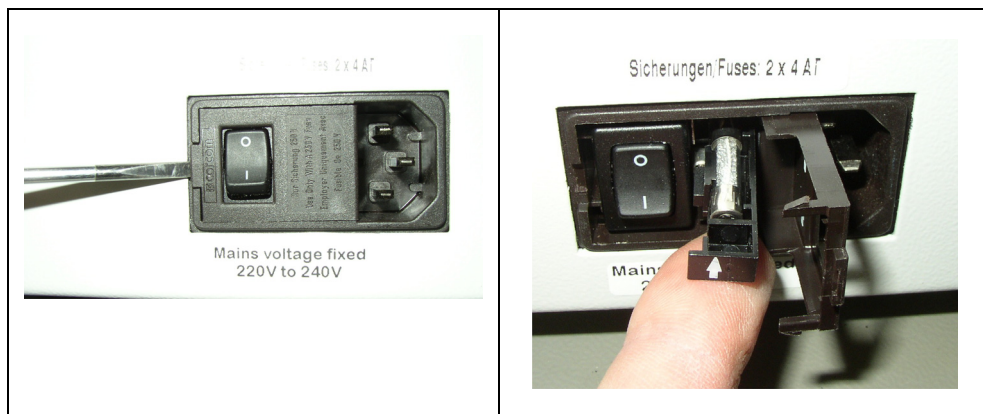

Fig. 8-7 Replacing the mains fuse

8.6 Replacing filters in the sniffer line

If the sniffer probe is clogged, a warning “Flow through capillary too low” (warning 35) will be issued.

Clogging of the sniffer probe may be due to:

- Clogging of capillary filter: see Section 8.6.1
- Clogging of sinter filter: see Section 8.6.3
- Clogging of sniffer probe capillary
- Damage of sniffer tip
- Clogging / damage of sniffer line

8.6.1 Replacing the felt discs of the capillary filter



Caution

The Ecotec E3000 must be recalibrated after any maintenance of the sniffer tip!

- 1 Switch off the Ecotec E3000.

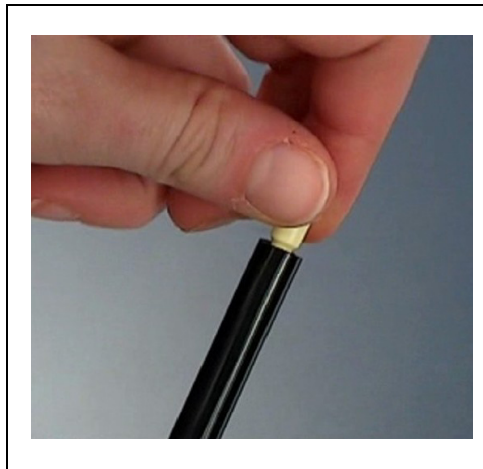

Fig. 8-8 Screwing off capillary filter

- 2 Unscrew capillary filter, push out old filter pads from the back side.

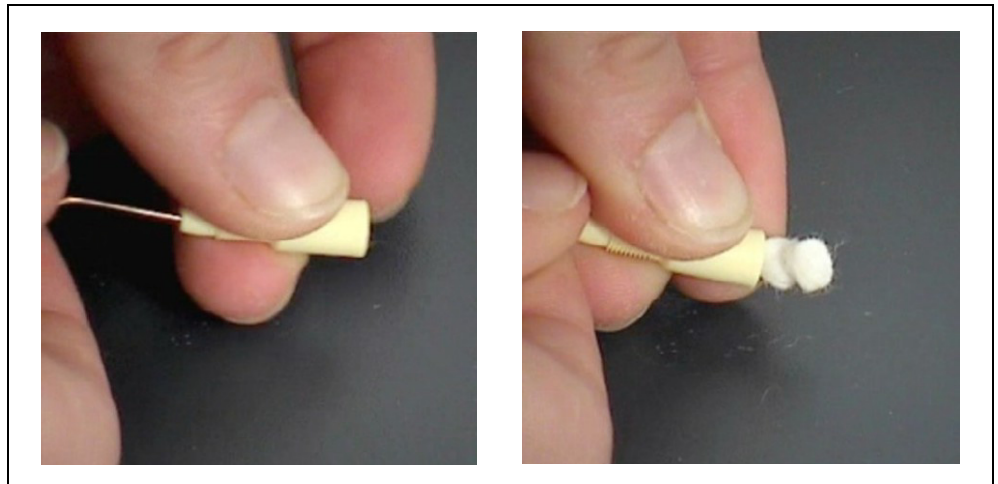

Fig. 8-9 Pushing out filter pads



Fig. 8-10 old and new filter pads

3 Push in new filter pads.

Notice: The metal grid is not included with the spare filter pads. Please clean the metal grid carefully and use it again.

4 Switch on the Ecotec E3000.

5 Hold finger against the capillary filter:
You should be able to feel the flow.

6 If warning "Flow through capillary too low" remains, replace the sinter filter (see Section 8.3)

7 From the main menu go to HISTORY & MAINTENANCE / CONFIRM MAINTENANCE / SNIFFER TIP FILTER and confirm with the ok button on the right side of the display that the sniffer tip filter has been replaced. The actual date and time as well as the actual number of operating hours will be saved and a reminder for maintenance will be issued again after the preset number of hours. For details see Chapter 4.7.

Notice: The Ecotec E3000 must be set to ADVANCED mode for confirming maintenance tasks.

8.6.2 Replacing the felt discs (with water protection tip)

- 1** Switch off Ecotec E3000!
- 2** Screw off water protection tip!
- 3** Push out filter pads and metal grid from the back side.
- 4** Re-install metal grid at the bottom of water protection tip.
- 5** Push in two new filter pads (all the way to the bottom of the water protection tip).
- 6** Switch on Ecotec E3000

Notice: If the flow has changed by more than 30%, a re-calibration of the Ecotec E3000 will be required and a corresponding warning will be issued by the software.

- 7** From the main menu go to HISTORY & MAINTENANCE / CONFIRM MAINTENANCE / SNIFFER TIP FILTER and confirm with the ok button on the right side of the display that the sniffer tip filter has been replaced.
The actual date and time as well as the actual number of operating hours will be saved and a reminder for maintenance will be issued again after the preset number of hours. For details see Chapter 4.7.
- 8** Please recalibrate the Ecotec E3000 for most accurate display of leak rate.

8.6.3 Checking / replacing the sinter filter

Notice: If the flow has changed by more than 30%, a re-calibration of the Ecotec E3000 will be required and a corresponding warning will be issued by the software.

- 1** Switch off the Ecotec E3000.
- 2** Remove the two Phillips screws and take off the sniffer tip.

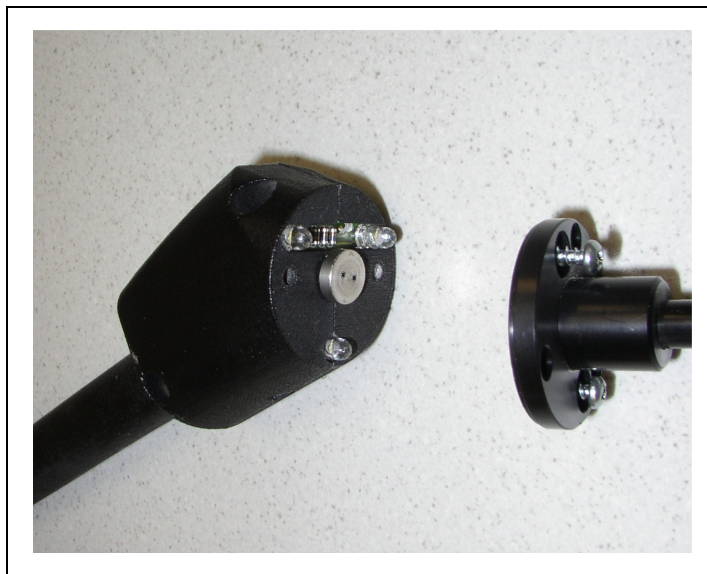

Fig. 8-11 Taking off the sniffer tip

- 3 Remove the sinter filter with the o-ring.



Fig. 8-12 Sinter filter

- 4 Visually check the filter for contamination.
- 5 Install a new sinter filter with o-ring at the bottom of the filter tip.
- 6 Reinstall the sniffer tip.
- 7 Switch on the Ecotec E3000.
- 8 Hold finger against the capillary filter:
You should be able to feel the resulting vacuum.
- 9 If the warning "Flow through capillary too low" remains after releasing the finger from the capillary filter, replace the sniffer tip first.
If this does not cure the problem, the capillary in the sniffer line is clogged and the complete sniffer line needs to be replaced.
- 10 Please recalibrate the Ecotec E3000 for most accurate display of leak rate.

8.7 Switching the capillary filter

At the top of the sniffer tip two different capillary filters can be mounted.

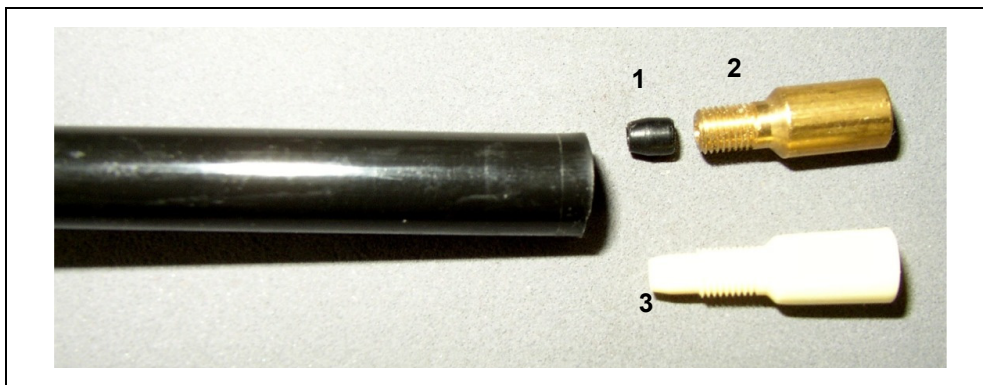

Fig. 8-13

Pos.	Description	Pos.	Description
1	Taper Gasket (can be black or white)	3	Plastic capillary filter
2	Metal capillary filter		

8.7.1 Switching from metal to plastic capillary filter

When you switch from the metal capillary filter to the plastic capillary filter you need to remove the taper gasket. The plastic capillary filter will not fit with the taper gasket installed.

- 1 Remove the two Philips screws in the flange of the sniffer tip and remove sniffer tip.
- 2 Take a small pin or needle (about 0.5 mm) and push the steel capillary out off the tip from the top.



Fig. 8-14 Pushing out the steel capillary

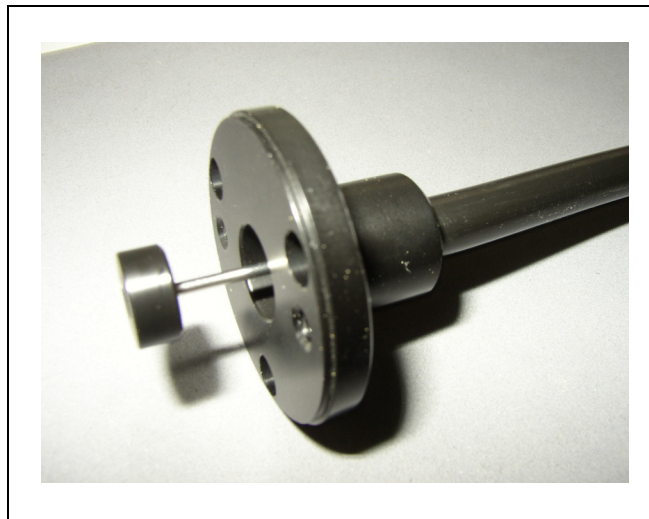

Fig. 8-15 Capillary sticking out of sniffer tip flange

The capillary may be removed in that way for the following sniffer tips:

cat. no.		length	
122 09	FT600	600 mm	flexible
122 13	ST312	120 mm	rigid
122 14	FT312	120 mm	flexible
122 15	ST385	385 mm	rigid
122 16	FT385	385 mm	flexible
122 18	FT200	200 mm	rigid
122 66	FT250	250 mm	flexible
122 72	ST500	500 mm	45° angled

- 3 Take out the steel capillary and remove the taper gasket at the top of the sniffer tip.

Notice: The capillary can be cleaned with compressed air or a thin steel wire.

- 4 Reinsert the steel capillary and reinstall the sniffer tip.
- 5 Screw the plastic capillary filter onto the sniffer tip.
- 6 Please recalibrate the Ecotec E3000 for most accurate display of leak rate.

8.7.2 Switching from plastic to metal capillary filter

- 1 Unscrew the plastic capillary filter.
- 2 Insert taper gasket (Fig. [Fig. 8-14/1](#))

Notice: When you switch from the plastic capillary filter to the metal capillary filter, do not forget to re-install the taper gasket as otherwise the sniffer line will be leaky.

- 3 Screw in metal capillary filter at the end of the sniffer tip.
- 4 Please recalibrate the Ecotec E3000 for most accurate display of leak rate.

8.8 Replacing the gas reservoir of the ECO-Check

Notice: Please take off the lid from the new gas reservoir 48 hours before installation. Due to accumulation of gas in the membrane during storage, the leak rate will be higher than certified right after opening. Do not use the new gas reservoir for calibration during this time.

- 1 Pull out the ECO-Check. The ECO-Check reference leak is fixed with magnetic holders and can be pulled out easily.

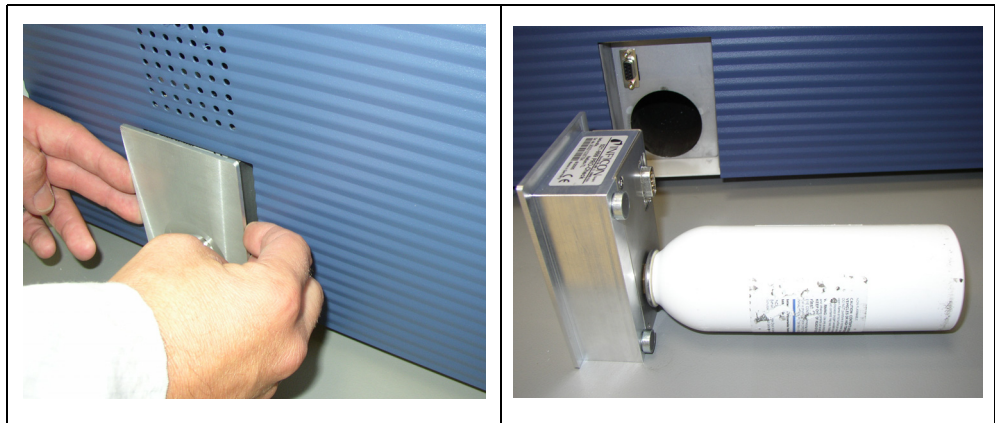

Fig. 8-16 Removing the ECO-Check reference leak from the main unit and dismantled

- 2 Screw off the gas reservoir counter clockwise, use hex nut key if necessary.



Caution

Inside of the holder is a glass tube and one O-ring which protects the photocell against dirt (Fig. 8-18,1). Pay attention to not loose or break this glass tube.

Notice: If the glass tube is dirty, please clean it carefully.

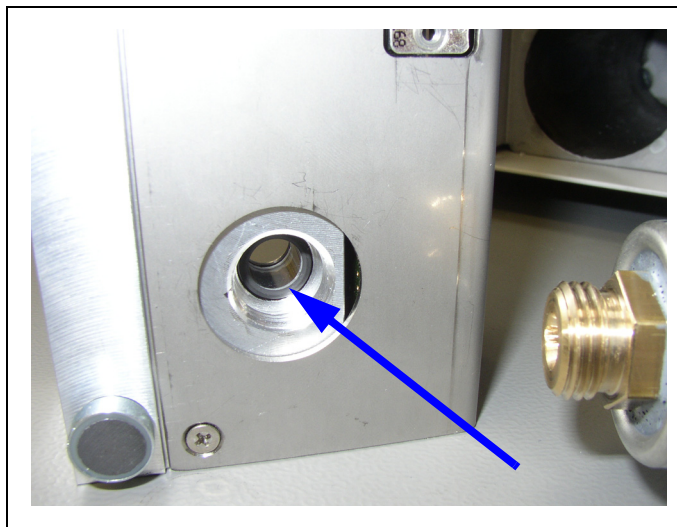

Fig. 8-17 O-Ring

- 3 Screw in the new gas reservoir.



Fig. 8-18 Installing the gas reservoir

Notice: Screw in the new reservoir with hex nut key only!

4 Re-install the ECO-Check in the Ecotec E3000.

Notice: The ECO-Check does not fit in the Ecotec E3000 completely. There is a little gap between the front panel of the Ecotec E3000 and the ECO-Check.

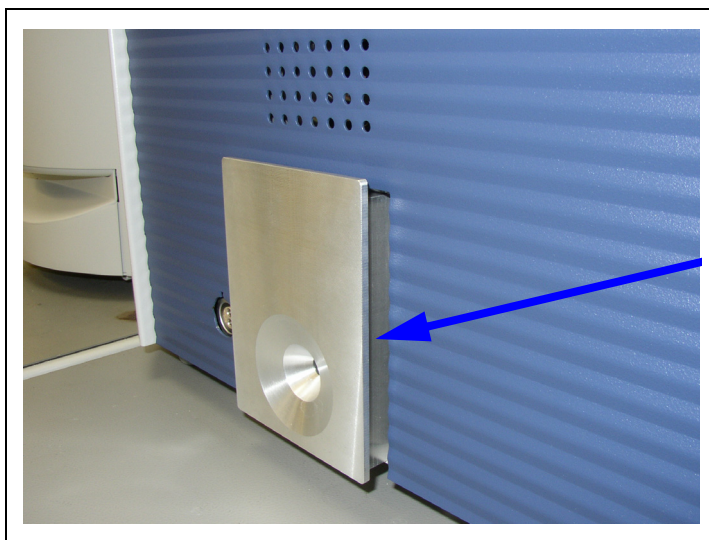

Fig. 8-19 Gap between ECO-Check and front panel

On the certificate which is delivered with the replacement gas reservoir you will find a new serial number and a 12-digit-code containing the new leak rate and other leak specific information. In the software menu please go to HISTORY & MAINTENANCE / REPLACE ECO-CHECK. In the opening sub-menu phase enter the new serial number in the first line and the 12-digit-code in the second line and press okay.

Notice: The Ecotec E3000 must be set to ADVANCED user mode for confirming maintenance tasks. (Go to SETTINGS / DISPLAY / USERMODE)

Notice: The ECO-Check reference leak must be installed in the Ecotec E3000 when pressing OK.

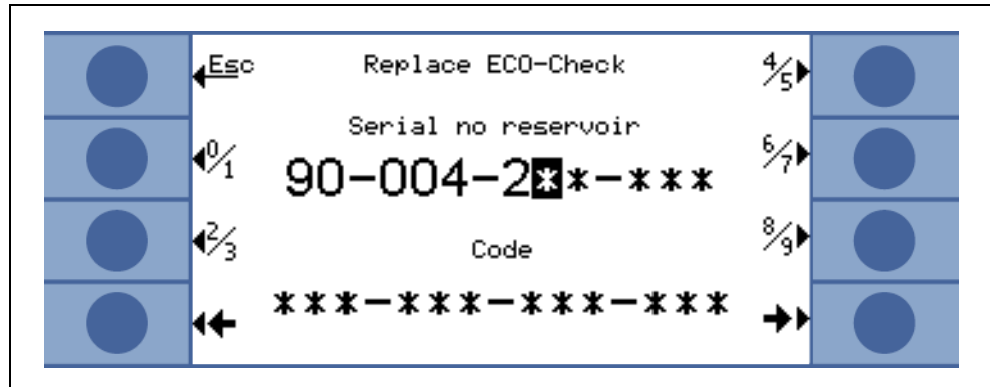

Fig. 8-20 Entry screen for replacing the ECO-Check

Notice: Entering the new leak relevant codes is important as otherwise an accurate calibration with the internal test leak and traceability of the calibration cannot be guaranteed.

Notice: The empty container is not reusable and should be disposed off according to national law.

9 Annex

9.1 The gas library

The operating software of the Ecotec E3000 contains a list of about 100 gases which are relevant to the refrigerating industry.

These gases are stored in a ROM (read only memory) and from the list contained in this memory gases and trigger levels may be selected through the corresponding sub-menus.

For each gas a mass number (measurement position), a molecular mass, a normalization factor and a resolution is stored.

The data contained in the ROM can not be changed. In addition, the program provides 40 unoccupied memory locations (user library RAM memory). Here the user may save the data of gases the parameters of which he has defined himself (see User Library). He may also select any gases defined earlier.

The library of the Ecotec E3000 contains the following gases by default:

Notice: For each gas the default mass position is highlighted in bold.

<i>Gas designation (max. 5 digits)</i>	<i>Other Designations</i>	<i>Meas. mass (xxx.x amu)</i>	<i>Molecule mass (xx.x amu)</i>	<i>Normalisation factor (Base value x.xEx)</i>
R11	CCl ₃ F	101.0	137.4	7.0E7
		103.0	137.4	7.0E7
R12	CCl ₂ F ₂	85.0	120.9	5.9E7
		87.0	120.9	5.9E7
		50.0	120.9	5.9E7
R12B1	Halon 1211	85	165.4	5.6E-7
		87	165.4	5.6E-7
R13	CBIF ₃	69.0	104.5	7.0E7
		85.0	104.5	3.5E8
R13B1		69	149.0	3.5E7
		129	149.0	3.5E7
		131	149.0	3.5E7
		148	149.0	3.5E7
		150	149.0	3.5E7

Gas designation (max. 5 digits)	Other Designations	Meas. mass (xxx.x amu)	Molecule mass (xx.x amu)	Normalisation factor (Base value x.xEx)
R14	CF ₄	69.0	88.0	7.0E7
		50.0	88.0	7.0E8
R21	CHCl ₂ F	67.0	102.9	7.0E7
		69.0	102.9	3.5E8
R22	CHClF ₂	51.0	86.5	7.6E7
		67.0	86.5	7.6E7
R23	CHF ₃	69.0	70.0	2.4E8
		51.0	70.0	2.4E8
		50.0	70.0	2.4E8
R32	CH ₂ F ₂	51.0	52.0	7.0E7
		52.0	52.0	7.0E8
R41	CH ₃ F	34.0	34.0	7.0E7
		33.0	34.0	7.0E7
R50	CH ₄ Methane	15.0	16.0	7.0E7
R113	CClF ₂ CCl ₂ F	101.0	187.4	7.0E7
		151.0	187.4	7.0E7
R114	CClF ₂ CClF ₂	85.0	170.9	7.0E7
		135.0	170.9	7.0E7
R115	CClF ₂ CF ₃	85.0	154.5	7.0E7
		119.0	154.5	7.0E7
R116	C ₂ F ₆	69.0	138.0	7.0E7
		119.0	138.0	7.0E7
R123	CHClFCF ₃	83.0	152.9	7.0E7
		85.0	152.9	7.0E7
R124	CHClFCF ₃	67.0	136.5	7.0E7
		51.0	136.5	7.0E7

Gas designation (max. 5 digits)	Other Designations	Meas. mass (xxx.x amu)	Molecule mass (xx.x amu)	Normalisation factor (Base value x.xEx)
R125	CHF ₂ CF ₃	51.0	120.0	7.0E7
		101.0	120.0	7.0E7
R134a	CF ₃ CH ₂ F	69.0	102.0	1.1E8
		83.0	102.0	1.1E8
		51.0	102.0	1.1E8
R141b	CCl ₂ FCH ₃	81.0	117.0	7.0E7
		67.0	117.0	7.0E7
R142b	CClF ₂ CH ₃	65.0	100.5	7.0E7
		85.0	100.5	7.0E8
R143a	CF ₃ CH ₃	69.0	84.0	7.0E7
		65.0	84.0	3.5E8
R152a	CHF ₂ CH ₃	51.0	66.1	8.7E7
		65.0	66.1	8.7E7
R170	Ethane C ₂ H ₆	26.0	30.1	7.0E7
R218	C ₃ F ₈	69.0	188.0	7.0E7
		169.0	188.0	3.5E8
R236fa		64	152.0	3.9E7
		69	152.0	3.9E7
		113	152.0	3.9E7
		133	152.0	3.9E7
R245fa	CF ₃ CH ₂ CF ₂ H	51.0	134	6.5E7
		64.0	134	6.5E7
		69.0	134	6.5E7
		95.0	134	6.5E7
		115.0	134	6.5E7

Gas designation (max. 5 digits)	Other Designations	Meas. mass (xxx.x amu)	Molecule mass (xx.x amu)	Normalisation factor (Base value x.xEx)
R290	Propane C ₃ H ₈	41.0	44.1	7.0E7
		39.0	44.1	7.0E7
		42.0	44.1	3.5E8
R356	Blend of CF ₃ (CH ₂) ₂ x CF ₃	77.0	166.1	7.0E7
		69.0	166.1	7.0E7
R400	Blend of 50%R12 50%R114	85.0	141.6	7.0E7
		135.0	141.6	3.5E8
R401A	Blend of 53% R22 13% R152a 34% R124	51.0	94.4	7.0E7
		67.0	94.4	7.0E7
		101.0	94.4	3.5E8
R401B	Blend of 61% R22 11% R152a 28% R124	51.0	92.8	7.0E7
		67.0	92.8	7.0E7
R401C	Blend of 33% R22 15% R152a 52% R124	51.0	101.0	7.0E7
		67.0	101.0	7.0E7
R402A	Blend of 38% R22 60% R125 2% R290	51.0	101.6	7.0E7
		101.0	101.6	3.5E8
R402B	Blend of 60% R22 38% R125 2% R290	51.0	94.7	7.0E7
		101.0	94.7	3.5E8
R403A	Blend of 75% R22 20% R218 5% R290	51.0	92.0	7.0E7
		69.0	92.0	3.5E8
R403B	Blend of 56% R22 39% R218 5% R290	51.0	103.3	7.0E7
		69.0	103.3	7.0E7

Gas designation (max. 5 digits)	Other Designations	Meas. mass (xxx.x amu)	Molecule mass (xx.x amu)	Normalisation factor (Base value x.xEx)
R404A	Blend of 44% R125 52% R143a 4% R134a	69.0	97.6	9.3E7
		51.0	97.6	9.3E7
		101.0	97.6	9.3E7
R405A	Blend of 45% R22 7% R152a 5.5% 142b 42.5% RC318	51.0	111.9	7.0E7
		100.0	111.9	7.0E7
R406A	Blend of 55% R22 4% R600a 41% R142b	51.0	89.9	7.0E7
		65.0	89.9	7.0E7
R407A	Blend of 20% R32 40% R125 40% R134a	51.0	90.1	7.0E7
		69.0	90.1	7.0E7
R407B	Blend of 10% R32 70% R125 20% R134a	51.0	102.9	7.0E7
		101.0	102.9	7.0E7
R407C	Blend of 23% R32 25% R125 52% R134a	51.0	86.2	1.9E8
		69.0	86.2	1.9E8
R407D	Blend of 15% R32 15% R125 70% R134a	83.0	86.2	4.7E8
		69.0	91.0	7.0E7
R407E	Blend of 25% R32 15% R125 60% R134a	83.0	91.0	7.0E7
		51.0	83.8	7.0E7
		69.0	83.8	7.0E7
R408A	Blend of 7% R125 46% R143a 47% R22	51.0	87.0	7.0E7
		69.0	87.0	7.0E7
R409A	Blend of 60% R22 25% R124 15% R142b	51.0	97.4	7.0E7
		67.0	97.4	7.0E7

Gas designation (max. 5 digits)	Other Designations	Meas. mass (xxx.x amu)	Molecule mass (xx.x amu)	Normalisation factor (Base value x.xEx)
R409B	Blend of 65% R22 25% R124 10% R142b	51.0	96.7	7.0E7
		67.0	96.7	7.0E7
R410A	Blend of 50% R32 50% R125	51.0	72.6	1.2E8
		101.0	72.6	1.2E8
		69.0	72.6	1.2E8
R410B	Blend of 45% R32 55% R125	51.0	75.6	7.0E7
		101.0	75.6	3.5E8
R411A	Blend of 1.5% R1270 87.5% R22 11% R152a	51.0	82.4	7.0E7
		67.0	82.4	7.0E8
R411B	Blend of 3% R1270 94% R22 3% R152a	51.0	83.1	7.0E7
		67.0	83.1	7.0E8
R411C	Blend of 3% R1270 95.5% R22 1.5% R152a	51.0	83.4	7.0E7
		67.0	83.4	7.0E8
R412A	Blend of 70% R22 5% R218 25% R142b	51.0	92.2	7.0E7
		65.0	92.2	3.5E8
R413A	Blend of 9% R218 88% R134a 3% R600	69.0	104.0	7.0E7
		83.0	104.0	7.0E7
R414A	Blend of 51% R22 28.5% R124 4% R600a 16.5% R142b	51.0	96.9	7.0E7
		67.0	96.9	7.0E7
R414B	Blend of 50% R22 39% R124 1.5% R600a 9.5% R142b	51.0	101.6	7.0E7
		67.0	101.6	7.0E7
R415A	Blend of 82% R22 18% R152a	51.0	81.7	7.0E7
		67.0	81.7	7.0E8

Gas designation (max. 5 digits)	Other Designations	Meas. mass (xxx.x amu)	Molecule mass (xx.x amu)	Normalisation factor (Base value x.xEx)
R416A	Blend of 59% R134a 39.5% R124 1.5% R600	69.0	111.9	7.0E7
		67.0	111.9	7.0E7
R500	Blend of 74% R12 26% R152a	85.0	99.3	7.0E7
		51.0	99.3	3.5E8
R501	Blend of 75% R22 25% R12	51.0	93.1	7.0E7
		85.0	93.1	3.5E8
R502	Blend of 49% R22 51% R115	85.0	111.6	7.0E7
		51.0	111.6	7.0E7
		119.0	111.6	7.0E7
R503	Blend of 40% R23 60% R13	69.0	87.3	7.0E7
		51.0	87.3	3.5E8
R504	Blend of 48% R32 52% R115	85.0	79.3	7.0E7
		51.0	79.3	7.0E7
R505	Blend of 78% R12 22% R31	85.0	103.5	7.0E7
		87.0	103.5	3.5E
R506	Blend of 55% R31 45% R114	68.0	93.7	7.0E7
		85.0	93.7	7.0E7
R507A	Blend of 50% R125 50% R143a	69.0	98.9	7.0E7
		51.0	98.9	7.0E7
R508A	Blend of 39% R23 61% R116	69.0	100.1	7.0E7
		51.0	100.1	3.5E8
R508B	Blend of 46% R23 54% R116	69.0	95.4	7.0E7
		51.0	95.4	3.5E8
R509A	Blend of 44% R22 56% R218	69.0	124.0	7.0E7
		51.0	124.0	7.0E7

Gas designation (max. 5 digits)	Other Designations	Meas. mass (xxx.x amu)	Molecule mass (xx.x amu)	Normalisation factor (Base value x.xEx)
R600	C ₄ H ₁₀ Butane	41.0	58.1	7.0E7
		42.0	58.1	7.0E7
R600a	C ₄ H ₁₀ Iso-Butane	41.0	58.1	2.0E8
		42.0	58.1	2.0E8
		58.0	58.1	2.0E8
R601	C ₅ H ₁₂ Pentane	41.0	72.2	7.0E7
		42.0	72.2	7.0E7
R601a	C ₅ H ₁₂ Iso-Pentane	41.0	72.2	7.0E7
		42.0	72.2	7.0E7
R601b	C ₅ H ₁₂ Neopentane	57.0	72.2	7.0E7
R601c	C ₅ H ₁₂ Cyclopentane	41.0	70.1	7.0E7
R1234	HFO-1234yf	69	114	1,6E8
		64	114	1,6E8
		95	114	1,6E8
		114	114	1,6E8
H2	Hydrogen	2.0	2.0	1.8E6
He	Helium	4.0	4.0	2.4E7
NH3	R717	17.0	17.0	7.0E7
H2O	R718	18.0	18.0	7.0E7
Ne	Neon	20.0	20.2	7.0E7
N2	Nitrogen	28.0	28.0	7.0E7
O2	Oxygen	32.0	32.0	7.0E7
Ar	Argon	40.0	40.0	7.0E7
CO2	R744	44.0	44.0	7.7E6
Kr	Krypton	84.0	83.8	7.0E7

Gas designation (max. 5 digits)	Other Designations	Meas. mass (xxx.x amu)	Molecule mass (xx.x amu)	Normalisation factor (Base value x.xEx)
Xe	Xenon	132.0	131.3	7.0E7
SF6		127.0	146.1	9.1E7
HT135	Galden HT135	100	610	1.2E7
		117	497	7.0E7
		119	497	7.0E7
		69	497	7.0E7
		135	497	7.0E7
ZT130	Galden ZT130	100	497	7.0E7
		69	610	1.2E7
		119	610	1.2E7
		169	610	1.2E7
		131	610	1.2E7

9.2 Declaration of Conformity



EC Declaration of Conformity

We – INFICON GmbH - herewith declare that the products defined below meet the basic requirements regarding safety and health of the relevant EC directives by design, type and the versions which are brought in to circulation by us.

In case of any products changes made without our approval, this declaration will be void.

The products meet the requirements of the following directives:

- *Directive on Low Voltage (2006/95/EC)*
- *Directive on Electromagnetic Compatibility (2004/108/EC)*
- *Directive on Machinery (2006/42/EC)*

Designation of the product:

Multi-Gas Leak Detector

Models:

**Ecotec E3000
Ecotec E3000RC**

Applied harmonized standards:

- **EN 61010 - 1 : 2001**
- **EN 61000-6-4 : 2002 Part EN 55011 Class B**
- **EN 61000-6-3 : 2002 Part EN 61000-3-2**
- **EN 61000-6-2 : 2005 Parts EN 61000-4-2
EN 61000-4-3
EN 61000-4-4
EN 61000-4-5
EN 61000-4-6
EN 61000-4-11**
- **DIN EN ISO 12100-1 / DIN EN ISO 12100-2**

Catalogue numbers:

**530-001
530-002
530-103
530-104
530-105
530-106**

During influence of strong electromagnetic interferences a temporary disturbance of the E3000 could occur.

Cologne, December 16, 2009



Dr. Döbler, Manager

ecotec e3000.16.12.2009.engl.doc

Cologne, December 16, 2009



Finke, Research and Development

INFICON GmbH
Bonner Strasse 498
D-50968 Cologne
Tel.: +49 (0)221 347-40
Fax: +49 (0)221 347-41429
www.inficon.com
E-mail: leakdetection@inficon.com

Appendix

A				
accessories		1-1, 1-9	flow limit	4-13
advanced mode		4-17	fuse	1-7, 1-18, 6-2, 8-8
air filter		8-3	G	
alarm		3-6, 4-14–4-15	gas flow	2-1
alarm delay		4-22	gas library	4-4, 4-9
ambient temperature		1-8	global trigger	4-19–4-20
audio volume		3-2–3-3	H	
autozero		1-12	history	4-34
B			I	
background		1-12, 2-4, 4-12	I/O Port	1-18–1-19, 7-1
basic menu		1-12	I/O port	4-23, 4-25, 4-32
C			I•Guide	3-8–3-9, 4-18
calibrated leak		1-9–1-10, 3-14	I•Guide mode	1-12
calibration		3-2, 3-4, 3-14, 3-16, 4-8, 4-34	installation	1-13
calibration factor		3-16, 3-19, 4-4, 4-35, 6-6	interface	2-3, 4-23
calibration history		4-35	internal calibration	3-16, 3-19, 4-4, 4-8
capillary filter		8-9	L	
connector		2-7	language	4-21
D			leak rate	4-23, 4-26
dimensions		1-8	lemo connector	1-13
E			loudspeaker	4-15
ECO-Check		1-7, 1-9, 1-13, 2-6, 3-14–3-16, 3-19, 4-4	M	
electrical connections		1-18	maintenance	8-1
electrical connectors		7-1	menu	1-11
error		3-12, 4-34, 6-1	menu button	3-4
error list		4-35	O	
error messages		6-1	output	4-23, 4-25, 7-1
error no.		6-2	P	
external calibration		3-17	PIN	4-3, 4-14
F			proof function	3-15
filter		8-9	R	
flow		1-8, 4-13, 4-30, 4-33, 6-3, 8-9, 8-12	recorder	4-32

recorder output 4-23
 right probe button 2-5, 3-5, 3-9, 3-11–3-12, 3-15–3-16, 4-17, 4-26
 RS232 interface 1-18–1-19, 4-23, 7-7
 RS232 protocol 4-26

S

self-test 3-14
 sensitivity check 4-13, 4-39
 sinter filter 8-10
 sleep 4-3, 4-25
 sniffer 4-31
 sniffer light 4-21
 sniffer line 1-13, 1-15, 2-4, 4-13, 4-30, 8-9
 sniffer probe 1-1, 2-4, 3-5, 8-9
 sniffer tip 0-7, 1-9, 3-6, 3-10, 3-15–3-16, 3-18
 sniffer tips 1-9

T

TMP 4-30, 6-1–6-2

transportation lock 1-13
 trigger 4-26
 turbo molecular pump 1-11, 2-1, 4-30, 6-1–6-2, 8-5
 turbo molecular pump (TMP) 2-2

U

User mode 4-17

V

verification 3-14

W

wake up 4-22
 warning 3-12, 6-1
 weight 1-8

Z

zero 1-12, 2-4, 3-3–3-7, 4-12, 4-32
 zero button 2-4, 3-4–3-6, 3-10, 4-12
 zero time 4-12



INFICON GmbH, Bonner Strasse 498, D-50968 Cologne, Germany
Phone: +49 (0)221 347-40 Fax: +49 (0)221 347-41429 E-mail: leakdetection@inficon.com

UNITED STATES TAIWAN JAPAN KOREA SINGAPORE GERMANY FRANCE UNITED KINGDOM HONG KONG
Visit our website for contact information and other sales offices worldwide. www.inficon.com

Dokument: kina22e1-p (1206)