

Performance, Reliability, and Versatility

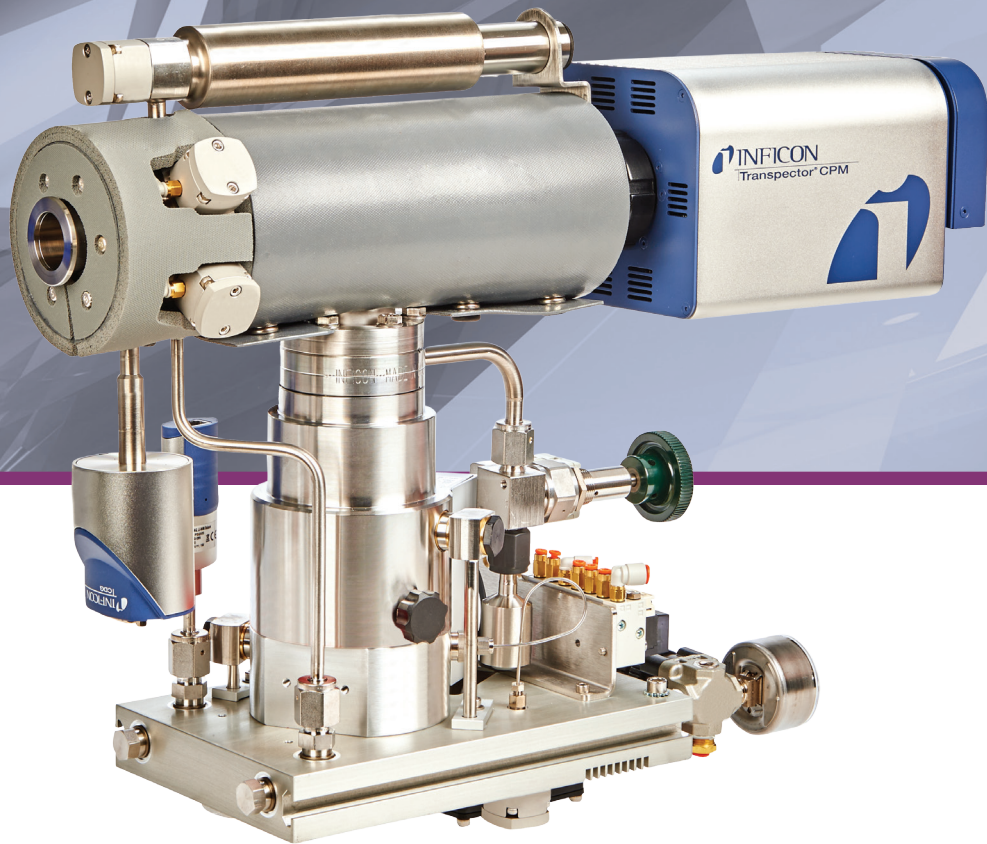

Transpector[®] CPM

Fast, Field-ready Process Monitoring System

Precision measurement for modern semiconductor processes

INFICON Transpector CPM has been the market-leading Residual Gas Analyzer (RGA) process monitoring system in the semiconductor industry for over a decade. Now Transpector CPM provides industry-leading measurement speed and sensitivity through a field-proven pumping and inlet system integrated with a new sensor and electronics. Transpector CPM is the ideal RGA process monitor for new and established semiconductor processes such as ALD, CVD, PVD, and etch.

TRANSPECTOR CPM IS FAST AND FIELD READY

INFICON understands that modern semiconductor processes are more demanding than ever. Designed to provide premier trace gas analysis for semiconductor applications, Transpector CPM is the choice instrument for monitoring advanced processes such as ALD and HDP CVD. Atomic layer processes require depositing extremely thin and uniform

films. Process optimization requires precise control over precursor chemical doses. With a measurement speed of 555 data points per second and industry-leading sensitivity, the enhanced Transpector CPM can meet the challenges of atomic layer deposition processes.

In addition to being the fastest RGA process monitor available, Transpector CPM also delivers maximum uptime due to a long life closed ion source and field-replaceable electron multiplier. To counter the extremely corrosive gases found in applications such as etch and CVD, the Transpector CPM HexBlock™ inlet is machined from a single piece of chemically resistant 316 stainless steel, and the turbo pump and foreline pump have been designed to maximize resistance to corrosion. Transpector CPM remains the most reliable and versatile RGA process monitor on the market.

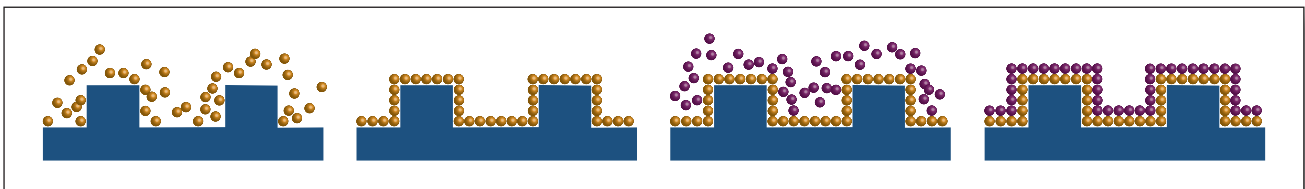

Transpector CPM has improved speed (555 data points per second) and industry-leading sensitivity to effectively monitor the challenges of ALD applications.

FEATURES AT A GLANCE

- ALD-ready with measurement speed of 1.8 ms per point (555 data points per second)
- Field-proven durability and reliability in the most demanding CVD and etch applications
- Application integration—Transpector CPM becomes a powerful process monitoring and diagnostics tool when integrated with FabGuard software and supported by INFICON world-class applications experts
- Compact size—allows for easy integration into production semiconductor equipment
- HexBlock with up to three pressure inlets and reduced surface area to minimize surface reactions and response times
- Corrosion resistant Capacitance Diaphragm Gauge (CDG)—CDG allows user to monitor the process pressure and automatically protect the system from pressure excursions
- Automated calibration—ensures long-term data stability and accuracy for sensor to sensor and tool to tool chamber matching



FAST DATA COLLECTION

Redesigned electronics enable shorter RF settling times for data collection speed up to 1.8 milliseconds per data point (approximately 555 data points per second). With this fast data speed, Transpector CPM is ideal for challenging semiconductor applications such as ALD and HDP CVD.

AUTOMATED CALIBRATION

Automated calibration can be easily performed with FabGuard software using an integrated calibration reference gas mixture.

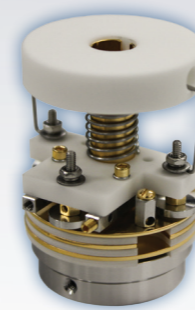

LONG-LIFE ION SOURCE

Transpector CPM includes a robust, field-replaceable closed ion source that will keep maintenance costs low over the lifetime of the instrument.

PROCESS CHARACTERIZATION AND MONITORING FOR:

- Advanced Processes including Atomic Layer Deposition (ALD)
- Etch processes including: metal, dielectric, silicon etch and high density plasma etch
- CVD Processes including: high k dielectrics, HDP-CVD, LP-CVD, SA-CVD, CVD low k, PE-CVD
- Diffusion and Epitaxy processes
- 300 mm wafer degas
- Ion implantation

SIMPLIFIED CABLE BOX DESIGN

Improved cable box design protects and organizes Transpector CPM cables.

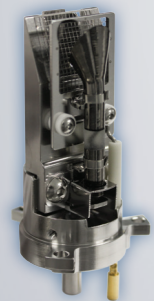

INNOVATIVE ELECTRON MULTIPLIER

A new low-noise, high-gain continuous dynode electron multiplier can be replaced in the field, resulting in decreased maintenance downtime and increased tool uptime.

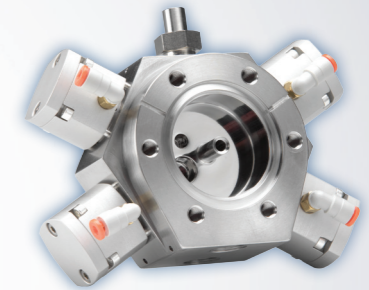

FIELD-PROVEN INLET SYSTEM

The Transpector CPM pumping and inlet system includes the INFICON field-proven HexBlock inlet—adaptable enough to sample up to three different process pressures, yet robust enough to withstand the most challenging corrosive applications.

PROCESS GAUGE

Upgraded corrosion resistant CDG process pressure gauge for longer life in aggressive applications.

FORELINE GAUGE

New Pirani foreline pressure gauge for simpler pumping system diagnostics.

FABGUARD DATA COLLECTION AND ANALYSIS

When integrated with the INFICON FabGuard software suite, Transpector CPM becomes a powerful process monitoring and diagnostics tool which can be used for:

- Advanced process control (end point detection)
- Statistical process control (SPC)
- Run-by-run and real-time fault detection and classification

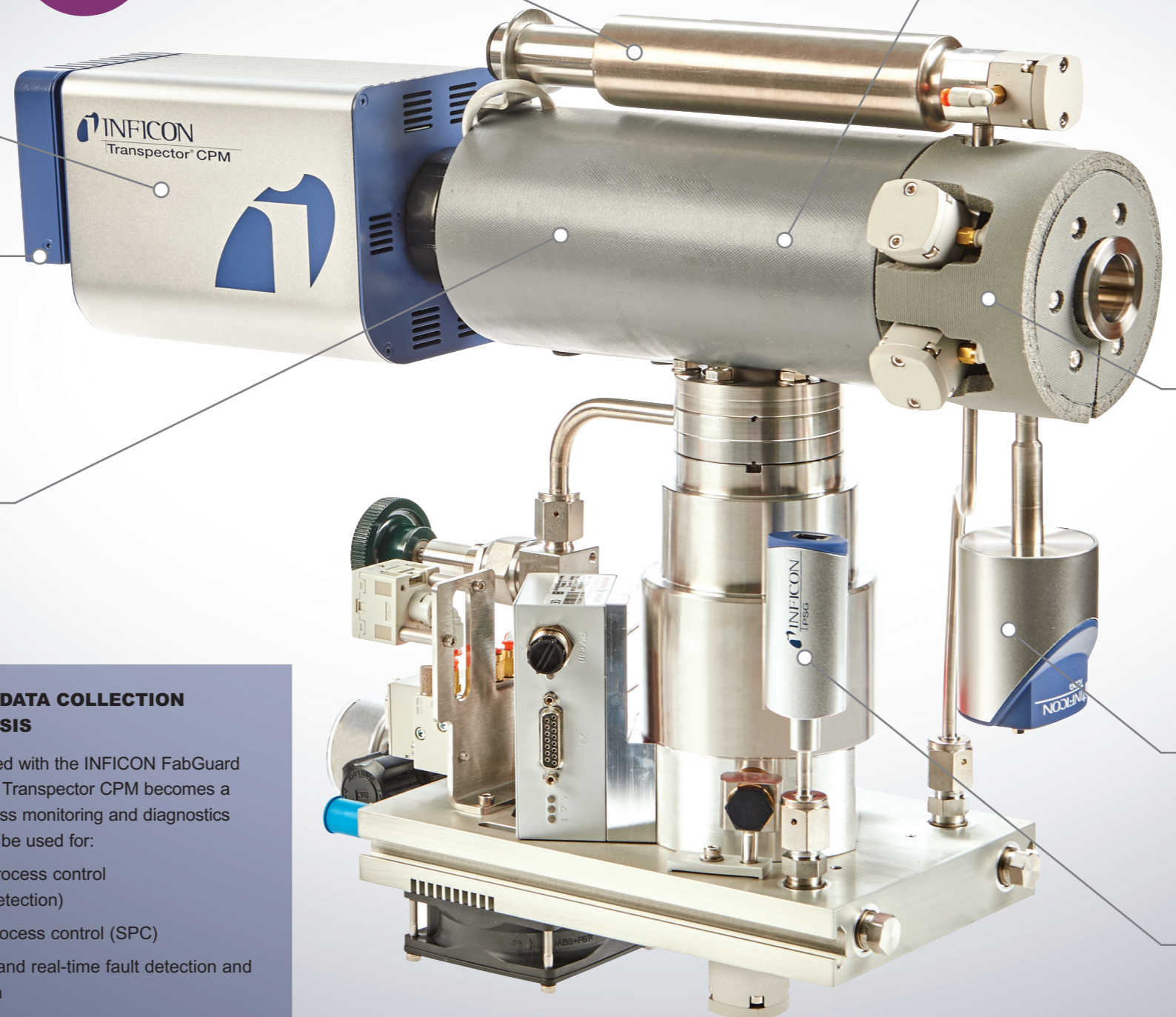



We have a global network of experts to provide fast and local applications and product support.

Transpector CPM has provided proven return on investment to our semiconductor partners for over a decade.

INDUSTRY-LEADING MEASUREMENT TECHNOLOGY

- Innovative sensor design for industry-leading sensitivity and stability leads to more accurate process control decisions in your fab.
- Modern electronic control with decreased RF settling times enables superior measurement speeds crucial for ALD analysis.
- Patented low noise, high gain electron multiplier means more measurement from your investment.

EASE OF MAINTENANCE

- Long lifetime components for longer mean time between maintenance.
- Field-replaceable electron multiplier, ion source, and gauges allow you to schedule maintenance at your convenience, taking repair delays out of the uptime equation.
- Field-serviceable diaphragm pump.

ROBUST AND ADAPTIVE ARCHITECTURE

- Configurable HexBlock inlet allows for sampling up to three different process pressures, enabling you to adjust according to the ever-changing semiconductor process landscape.
- Wide pressure measurement range from high vacuum to atmosphere
- Corrosion resistant inlet, pumping package, and sensor for harsh environment manufacturing. Includes the Transpector CPM ion source with an additional anode liner which can be configured specifically for CVD or etch applications.

SUPERIOR PRODUCT SUPPORT

- World leader in RGAs for the semiconductor market for decades, with a global network of experts to provide fast and local applications and product support.
- INFICON has the resources, expertise, and experience to develop innovative, reliable monitoring systems that enhance yields.

SPECIFICATIONS

Mass range	1 to 100 amu	1 to 200 amu	1 to 300 amu
Peak width @ 10% peak maximum	<1 amu		
Ion source type	Closed Ion Source		
Total pressure range ¹	5E-7 to 1E-3 Torr (6.6E-7 to 1.3E-3 mbar)		
Total pressure accuracy ²	±25% 1E-6 to 1E-3 Torr (1.3E-6 to 1.3E-3 mbar)		
Maximum ion source operating pressure ³	1E-3 Torr (1.3E-3 mbar)		
Nominal ion source operating pressure ⁴	2E-4 Torr (2.6E-4 mbar)		
System operating pressure (with orifices/capillary)	1E-8 Torr (1.3E-8 mbar) to 1.2 atmospheres		
Sensitivity			
@ low emission, FC mode	>4.0E-6 amps/Torr (>3E-6 amps/mbar)	>2.0E-6 amps/Torr (>1.5E-6 amps/mbar)	>1.0E-6 amps/Torr (>7.6E-7 amps/mbar)
@ high emission, FC mode	>2.0E-5 amps/Torr (>1.5E-5 amps/mbar)	>1.0E-5 amps/Torr (>7.6E-6 amps/mbar)	>5.0E-6 amps/Torr (>3.8E-6 amps/mbar)
Minimum detectable partial pressure ⁵	1.0E-13 Torr (1.3E-13 mbar)	2.0E-13 Torr (2.6E-13 mbar)	4.0E-13 Torr (5.3E-13 mbar)
Maximum Data Rate (analog scans OR selected peaks)	1.8 ms per point (555 data points per second)		
Abundance sensitivity ⁶	<5 ppm	<10 ppm	<100 ppm
Zero blast ⁷	<2 ppm	<25 ppm	<200 ppm
Detection limit ⁸	<1 ppm	<2 ppm	<4 ppm
Linearity ⁹	±20%		
Minimum background pressure	<1.0E-8 Torr (<1.3E-8 mbar)		
Maximum sensor and inlet operating temperature	150°C		

1 Pressure reading at low emission using total pressure lens

2 Total pressure accuracy at low emission

3 Maximum ion source operating pressure at low emission (filament turn-off threshold)

4 2E-4 Torr in the closed ion source will produce about 1E-5 Torr in the quadrupole region

5 MDPP with EM on at 10,000 gain and 1-second dwell time

6 Mass 40 contribution onto 41 amu

7 Zero blast contribution onto 2 amu

8 Minimum detectable concentration with krypton in air at a 1-second dwell

9 For 1 Torr orifices and lower. Linearity at low emission at 0.1 to 2 times the nominal orifice pressure



DIMENSIONS

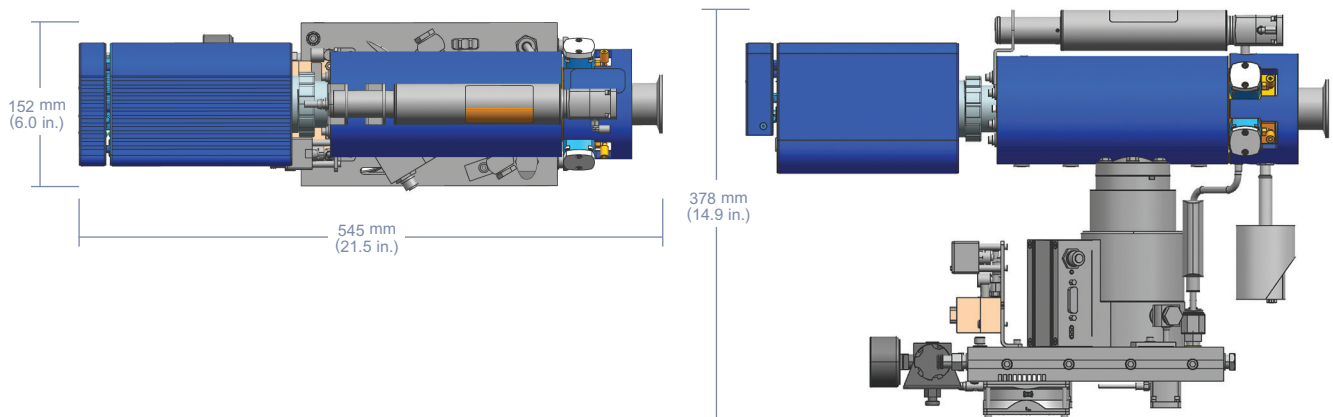

 **INFICON** Instruments for Intelligent Control®

www.inficon.com reachus@inficon.com

Transpector and FabGuard are registered trademarks of INFICON and HexBlock is a trademark of INFICON.

Due to our continuing program of product improvements, specifications are subject to change without notice.

aibc04a1-d ©2015 INFICON