

## Intended Use

The Bayard Alpert Pirani Gauges of the type BPG400-SD, BPG400-SP and BPG400-SR have been designed for vacuum measurement of non-flammable gases and gas mixtures in a pressure range of  $5 \times 10^{-10}$  ... 1000 mbar.

## Bayard Alpert Pirani Gauge

With Fieldbus Interface

BPG400-SD, BPG400-SP, BPG400-SR

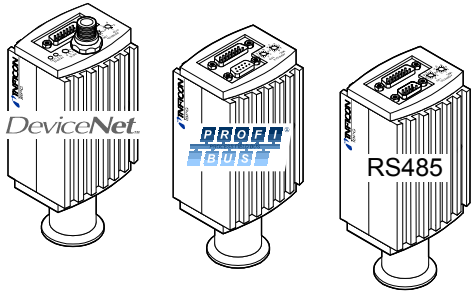

Instruction Sheet

tima36e1-b (2004-02)



### About this document

This document is a supplement to the standard Instruction Sheet enclosed with the BPG400 (→ [1]). It should be used together with the standard Instruction Sheet.

The symbol (→ [XY]) refers to documents and files listed under "Further Information".

## Product Identification

In all communications with INFICON, please specify the information on the product nameplate. For convenient reference copy that information into the space provided below.

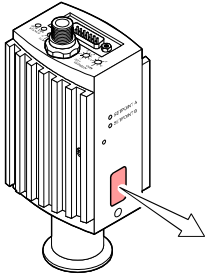

INFICON AG, LI-9496 Balzers  
 Model: \_\_\_\_\_  
 PN: \_\_\_\_\_  
 SN: \_\_\_\_\_  
 \_\_\_\_\_ V \_\_\_\_\_ W

## Validity

This document applies to products with the following part numbers:

BPG400-SD (DeviceNet):  
 353-507 (DN 25 ISO-KF)  
 353-508 (DN 40 CF-R)

BPG400-SP (Profibus):  
 353-505 (DN 25 ISO-KF)  
 353-506 (DN 40 CF-R)

BPG400-SR (RS485):  
 353-509 (DN 25 ISO-KF)  
 353-513 (DN 40 CF-R)

The part number (PN) can be taken from the product nameplate.

If not indicated otherwise in the legends, the illustrations in this document correspond to the vacuum connection DN 25 ISO-KF. They apply to other vacuum connections by analogy.

We reserve the right to make technical changes without prior notice.

All dimensions in mm.

## Trademarks

DeviceNet™ Open DeviceNet Vendor Association, Inc.

## Safety

### Symbols Used

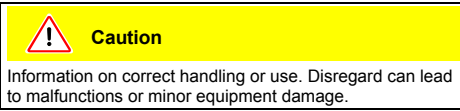
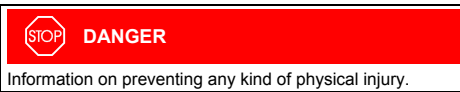

### Personnel Qualifications

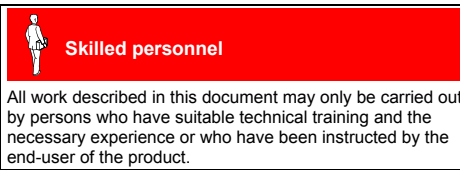

### General Safety Instructions

All safety instructions given in [1] and [2] apply to the sensor types described in this document, too.

### Liability and Warranty

INFICON assumes no liability and the warranty becomes null and void if the end-user or third parties

- disregard the information in this document
- use the product in a non-conforming manner
- make any kind of changes (modifications, alterations etc.) to the product
- use the product with accessories not listed in the product documentation.

The end-user assumes the responsibility in conjunction with the process media used.

## BPG400-SD (DeviceNet)

DeviceNet™

### General Information

The BPG400-SD gauge has a fieldbus interface that conforms to the DeviceNet standard (→ [8]).

Via this interface, the following and further data are exchanged in the standardized DeviceNet Protocol (→ [3], [8]):

- Pressure reading
- Pressure unit (Torr, mbar, Pa)
- Degas function
- Gauge adjustment
- Status and error messages

Two adjustable switching functions are integrated in the gauge. The corresponding relay contacts are available at the sensor cable connector.

The basic sensor and sensor electronics of the BPG400-SD type are the same as in the standard BPG400 (→ [1], [2]).

### Technical Data



General technical data of the sensor and sensor electronics → [1], [2]

### Fieldbus Interface

Fieldbus name	DeviceNet
Standard applied	→ [8]
Communication protocol, data format	→ [3], [8]
Interface, physical	CAN bus

### DeviceNet Parameters

Data rate (adjustable via "RATE" switch)	125 kBaud 250 kBaud 500 kBaud "P" (programmable 125 kBaud, 250 kBaud, 500 kBaud via DeviceNet (→ [3])
Node address (MAC ID) (adjustable via "ADDRESS, MSD, LSD" switches)	0 ... 63 <sub>dec</sub> "P" (programmable 0 ... 63 via DeviceNet (→ [3])

DeviceNet connector	Micro-Style, 5 pins, male
Cable	Shielded special DeviceNet cable, 5 conductors (→ [8], [6])
Cable length, system wiring	According to DeviceNet specifications (→ [8], [6])

### Supply Voltages



The power consumption of the BPG400-SP is higher than that of the standard BPG400 (→ [1], [2]).

Supply voltage at the sensor connector, Pin 8	+24 VDC (+20 ... 28 V)
Power consumption	<18 W



DeviceNet operation requires an additional, separate power supply.

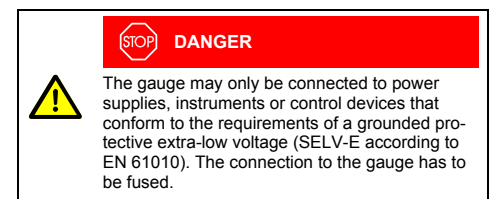

Supply voltage at the DeviceNet connector, Pin 2	+24 VDC (+11 ... 25 V)
Power consumption	<2 W

The gauge is protected from reversed polarity of the supply voltage.

## Sensor Cable Connection

For reasons of compatibility, the expression "sensor cable" is used in this document, although the pressure reading of the SD-type gauge is normally transmitted via the DeviceNet interface.

Connector	D-Sub, 15 pins, male
Cable	Max. 15 conductors, shielded
Cable length, (conductor cross section per conductor)	≤35 m (0.25 mm <sup>2</sup> ) ≤50 m (0.34 mm <sup>2</sup> ) ≤100 m (1.0 mm <sup>2</sup> )
Switching functions	2 Setpoints adjustable via potentiometers (Setpoints A and B), one floating, normally open contact per setpoint
Relay contact rating	
Voltage	≤60 VDC
Current	≤0.5 A
Gauge identification	42 kΩ between Pin 10 (sensor cable) and GND
Grounding principle	→ "Electrical Connection"

## Dimensions [mm]

Housing and vacuum connection → [1], [2]

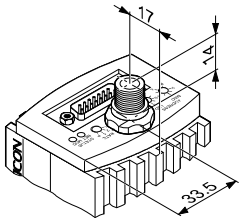

Weight	
353-507	≈430 g
353-508	≈695 g

## Electrical Connection

### Sensor Cable Connection

Make sure the vacuum connection is properly made (→ [1], [2], "Vacuum Connection").

1 If no sensor cable is available, make one according to the diagram.

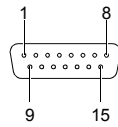
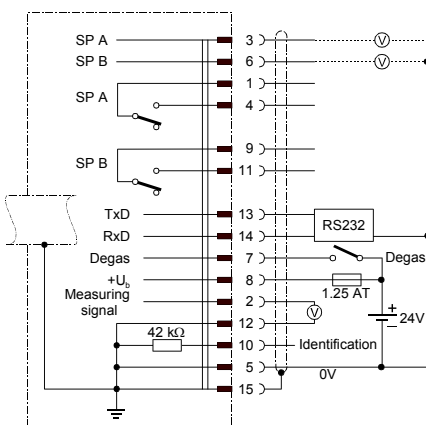

D-Sub, 15 pins, female soldering side

Pin 1	Relay switching function A, COM contact	
Pin 2	Signal output (measuring signal)	0 ... +10 V
Pin 3	Threshold (Setpoint) A	0 ... +10 V
Pin 4	Relay switching function A, N.O. contact	
Pin 5	Supply common GND	
Pin 6	Threshold (Setpoint) B	0 ... +10 V
Pin 7	Degas on, active high	+24 V
Pin 8	Supply of sensor electronics	+24 V
Pin 9	Relay switching function B, common	
Pin 10	Gauge identification	
Pin 11	Relay switching function B, N.O. contact	
Pin 12	Signal common GND	
Pin 13	RS232 TxD	
Pin 14	RS232 RxD	
Pin 15	Housing, shielding, GND	

2 Connect the sensor cable to the gauge and secure it using the lock screws:

## DeviceNet Cable Connection

1 If no DeviceNet cable is available, make one according to the following indications:

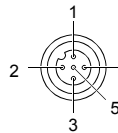

Micro-Style, 15 pins, (DeviceNet), female soldering side

Pin 1	Drain	
Pin 2	Supply (DeviceNet interface only)	+24 VDC
Pin 3	Supply common (DeviceNet interface only)	GND
Pin 4	CAN_H	
Pin 5	CAN_L	

2 Connect the DeviceNet cable to the gauge and lock the cable connector.

✓ The gauge can now be put into operation.

## Data Rate Setting



By means of the "RATE" switch, the data rate can be set to 125 ("1"), 250 ("2") or 500 kBaud ("5").

If the switch is in any of the "P" positions, the data rate is programmable via the DeviceNet (→ [3]).

The admissible data rate depends on several factors (system parameters, cable lengths etc.) (→ [8]).

## Adjusting the Gauge

→ Adjustment and settings.

## Adjusting the Switching Functions

→ Adjustment and settings.

## Status Lights



### "STATUS MOD" (gauge status):

Light status	Meaning
Dark	No supply
Flashing red/green	Selftest
Green	Normal operation
Red	Non recoverable error

### "STATUS NET" (network status):

Light status	Meaning
Dark	Gauge not online: – Selftest not yet concluded – No supply, → "STATUS MOD" light
Flashing green	Gauge online but no connection: – Selftest concluded, but no connection to other nodes established – Gauge not assigned to any master
Green	Gauge online; necessary connections established
Flashing red	One or several input/output connections in "timed out" status
Red	Communication error. The gauge has detected an error that impedes communication via the network (e.g. two identical node addresses (MAC ID) or "Bus-off")

## Operation

**Caution**

**Caution: data transmission errors**  
If the gauge is operated via an RS232 interface and the DeviceNet at the same time, data transmission errors may occur.  
The gauge must not be operated via an RS232 interface and the DeviceNet at the same time.

## Operating Software

Before the gauge is put into operation, it has to be configured for the DeviceNet. A configuration tool and the device specific EDS file (Electronic Data Sheet) are required for this purpose. This software can be downloaded via internet (→ [5]).

## Node Address Setting



Set the node address (0 ... 63<sub>dec</sub>) via the "ADDRESS" "MSD" and "LSD" switches. The node address is polled by the firmware when the gauge is switched on. If the setting deviates from the stored value, the new value is taken over into the NVRAM. If a setting higher than 63 is made, the previous node address setting remains valid. If the MSD switch is in the "P" position, the node address is programmable via the DeviceNet (→ [3]).



(2004-02)

## BPG400-SP (Profibus)



### General Information

The BPG400-SP gauge has a fieldbus interface that conforms to the Profibus DPV1 standard (→ [9]).

Via this interface, the following and further data are exchanged in the standardized Profibus protocol (→ [1], [2]):

- Pressure reading
- Pressure unit (Torr, mbar, Pa)
- Degas function
- Gauge adjustment
- Status and error messages

Two adjustable switching functions are integrated in the gauge. The corresponding relay contacts are available at the sensor cable connector.

The basic sensor and sensor electronics of the BPG400-SP type are the same as in the standard BPG400 (→ [1], [2]).

### Technical Data BPG400-SP



General technical data of the sensor and sensor electronics → [1], [2].

### Fieldbus Interface

Fieldbus name	Profibus
Standard applied	→ [9]
Communication protocol, data format	→ [4], [9]
Interface, physical	RS485

Profibus Parameters	
Data rate	≤12 MBaud (→ [4], [9])
Node address	00 ... 7D <sub>hex</sub> (0 ... 125 <sub>dec</sub> )

Profibus connection	
Cable	D-Sub, 9 pins, female Shielded special Profibus cable (→ [9], [7])
Cable length, system wiring	According to Profibus specifications (→ [9], [7])

### Supply Voltages



The power consumption of the BPG400-SP is higher than that of the standard BPG400.

Supply voltage at sensor cable connector, Pin 8	+24 VDC (+20 ... 28 V)
Power consumption	<18 W

### Sensor Cable Connection

→ "Technical Data, Sensor Cable Connection" of the gauge BPG400-SD (identical).

### Dimensions

Housing and vacuum connection → [1], [2]

Weight	
353-505	≈425 g
353-506	≈685 g

### Electrical Connection

Make sure the vacuum connection is properly made (→ [1], [2], "Vacuum Connection").

### Sensor Cable Connection



If no sensor cable is available, make one according to the diagram shown in the BPG400-SD section (identical).



Connect the sensor cable to the gauge and secure the sensor cable connector using the lock screws.

## Profibus Cable Connection



If no Profibus cable is available, make one according to the following indications:

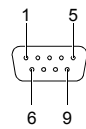

D-Sub, 9 pins, male soldering side

Pin 1	not connected
Pin 2	not connected
Pin 3	RxD/TxD-P
Pin 4	CNTR-P
Pin 5	DGND
Pin 6	VP
Pin 7	not connected
Pin 8	RxD/TxD-N
Pin 9	not connected

1) Only to be connected if an *optical link* module is used.

2) Only required as line termination for devices at both ends of bus cable (→ [9]).



Connect the Profibus cable to the gauge and secure the Profibus cable connector using the lock screws.



The gauge can now be put into operation.

### Operation

**Caution**

**Caution: data transmission errors**  
If the gauge is operated via an RS232 interface and the DeviceNet at the same time, data transmission errors may occur.  
The gauge must not be operated via an RS232 interface and the DeviceNet at the same time.

### Operating Software

For operating the gauge via the Profibus network, prior installation of the gauge specific GSD file is required. This software can be downloaded via internet (→ [5]).

### Note Address Setting

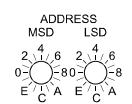

The node address (0 ... 125<sub>dec</sub>) is set in hexadecimal form (00 ... 7D<sub>hex</sub>) via the "ADDRESS", "MSD", and "LSD" switches. The node address is polled by the firmware when the gauge is switched on. If the setting deviates from the stored value, the new value is taken over into the NVRAM. If a value >125<sub>dec</sub> (>7D<sub>hex</sub>) is entered, the node address setting currently stored in the device remains valid but it can now be defined via Profibus ("Set slave Address", → [4]).

### Adjusting the Gauge

→ "Adjustment and settings".

### Adjusting the Switching Functions

→ "Adjustment and settings".

## BPG400-SR (RS485)

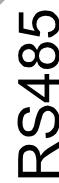

### General Information

The BPG400-SR gauge has a RS485 fieldbus interface.

Via this interface, the following and further data are exchanged (→ [1], [2]):

- Pressure reading
- Pressure unit (Torr, mbar, Pa)
- Degas function
- Gauge adjustment
- Status and error messages
- Threshold values of switching functions

Two adjustable switching functions are integrated in the gauge. The corresponding relay contacts are available at the sensor cable connector. Additionally, the Relay contact of switchingfunction A is also available at the interface connector.

The basic sensor and sensor electronics of the BPG400-SR type are the same as in the standard BPG400 (→ [1], [2]).

### Technical Data BPG400-SR

General technical data of the sensor and sensor electronics → [1], [2].

### Fieldbus Interface

Name	RS485
Communication protocol, data format	→ [2]
RS485 parameters	
Data rate	300 ... 28'800 Baud
Device address	00 ... 7F <sub>hex</sub> (0 ... 127 <sub>dec</sub> )
RS485 connection	
Cable	D-Sub, 9 pins, male 1 twisted pair, shielded (→ [2])

### Supply Voltages



The power consumption of the BPG400-SR is higher than that of the standard BPG400.

Supply voltage at sensor cable connector, Pin 8	+24 VDC (+20 ... 28 V)
Power consumption	<18 W

### Sensor Cable Connection

→ "Technical Data, Sensor Cable Connection" of the gauge BPG400-SD (identical).

### Dimensions

Housing and vacuum connection → [1], [2]

Weight	
353-509	≈425 g
353-513	≈685 g

### Electrical Connection

Make sure the vacuum connection is properly made (→ [1], [2], "Vacuum Connection").

### Sensor Cable Connection



If no sensor cable is available, make one according to the diagram shown in the BPG400-SD section (identical).



Connect the sensor cable to the gauge and secure the sensor cable connector using the lock screws.

### RS485 Cable Connection



If no RS485 cable is available, make one according to the following indications:

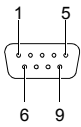

D-Sub, 9-pin, male, soldering side

Pin 1	Setpoint A relay, N.O.	1)
Pin 2	Do not connect	
Pin 3	No connection	
Pin 4	Do not connect	
Pin 5	Setpoint A relay, N.C.	1)
Pin 6	RS485 (-) Input	2)
Pin 7	Setpoint A relay, COM	1)
Pin 8	No connection	
Pin 9	RS485 (+) Input	2)

- The changeover relay contact available on the RS485 interface connector is galvanically connected to the N.O. relay contact of the setpoint A.
- In order to minimize cable reflections, the bus cable must be terminated at both ends with appropriate termination resistors.

- Connect the RS485 cable to the gauge and secure the RS485 cable connector using the lock screws.

✓ The gauge can now be put into operation.

## Operation

**Caution**

Caution: data transmission errors  
If the gauge is operated via RS485 and RS232C interface at the same time, data transmission errors may occur.  
The gauge must not be operated via RS485 and RS232C interface at the same time.

## Communication Protocol

The controlling host sends its commands to the individually addressed devices (gauges) connected to the bus. In reply the device returns the data requested via bus to the host.

A maximum of 127 devices can be connected to a RS485 bus system.

The device address (base address) setting is primarily made on the gauge. Via RS485 communication, an address offset can be added from the host:

$$\text{Operating device address} = \text{base address} + \text{Offset}$$

where:

Operating device address	00 ... 7F <sub>hex</sub> <sup>1)</sup>
Base address (Switches)	00 ... 7F <sub>hex</sub>
Offset (from host)	00 ... 7F <sub>hex</sub>

- Sum of base address and offset must not exceed 7F<sub>hex</sub>.

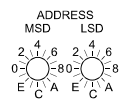

The base address (0 ... 127<sub>dec</sub>) is set in hexadecimal form (00 ... 7F<sub>hex</sub>) via the "ADDRESS", "MSD", and "LSD" switches. The address is polled by the firmware when the gauge is switched on only. If the address set by the switches is above the allowed range, all parameters are set to the factory default values. Communication is not possible in this case.

## Adjusting the Gauge

→ "Adjustment and settings".

## Adjusting the Switching Functions

→ "Adjustment and settings".

On the BPG400-SR, lower and upper thresholds can be set individually (only via RS485), if certain conditions are met (→ [2]).

## Adjustment and Settings

For BPG400-SD, BPG400-SP and BPG400-SR gauges.

### Adjusting the Gauge

The gauge is factory calibrated. If used under different climatic conditions, at extreme temperatures, through aging or contamination and after exchanging the sensor, the characteristic curve can be offset and readjustment can become necessary. Only the Pirani element can be adjusted and only at atmosphere.

Readjustment becomes necessary if

- at atmosphere the output voltage is <10 V or the display reading is <atmosphere
- when venting the vacuum system, the output voltage reaches 10 V before the measured pressure has reached atmosphere.

- If you are using a seal with centering ring and filter, check that they are clean or replace them if necessary (→ [1], [2], "Deinstallation").

- Activate the gauge.



Operate the gauge for ≈10 minutes at atmospheric pressure. If the gauge was operated within the Ioni range, a cooling-down time of ≈30 minutes is to be expected (gauge temperature = environmental temperature).

- Adjusting the gauge:

Insert a Pin (≈0.13 mm) through the opening and push the button inside for at least 5 seconds.

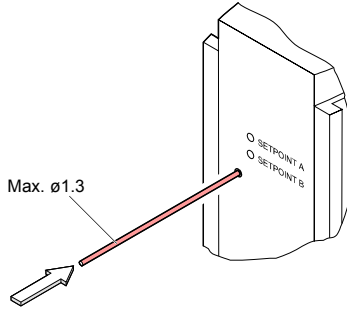

The gauge is now automatically adjusted. The adjustment takes ≈4 s.

- The gauge is now adjusted.

### Setting the Switching Functions

The threshold values of switching functions A and B can be set within the pressure range  $1 \times 10^{-9}$  mbar ... 100 mbar via potentiometers "SETPOINT A" and "SETPOINT B". For the corresponding threshold voltages  $U_{\text{Threshold}}$ , the following equation applies:

For BPG400-SD, -SR:

$$U_{\text{Threshold}} = 0.75 \times (\log p_{\text{Setpoint}} - c) + 7.75$$

For BPG400-SP:

$$U_{\text{Threshold}} = 0.8129401 \times (\log p_{\text{Setpoint}} - c + 9.30102999)$$

Constant c depends on the pressure unit (→ [1], [2]).

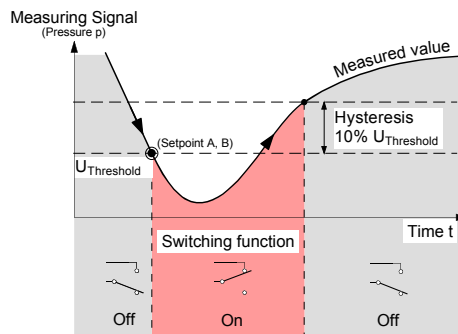

The hysteresis of the switching function is 10% of the threshold setting.

- Put the gauge into operation.
- Connect the +lead of a voltmeter to the threshold measurement point of the selected switching function ("Setpoint A" Pin 3, "Setpoint B" Pin 6) and its -lead to Pin 5.

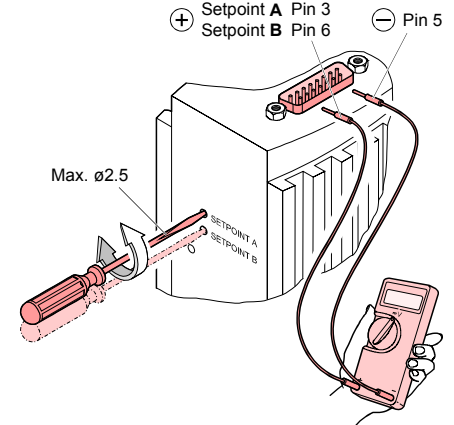

- Using a screwdriver (max. ø2.5 mm), set the threshold of the selected switching function (Setpoint A, B) to the desired value  $U_{\text{Threshold}}$ .



On the BPG400-SR, lower and upper thresholds can be set individually (only via RS485 interface, → [2]).

A functional check of the switching functions (On/Off) is only possible via fieldbus interface (→ [3] for BPG400-SD, → [4] for BPG400-SP and → [2] for BPG400-SR) or by measuring the relay contacts with a continuity checker/ohmmeter (→ "Electrical Connection", sensor cable connector).

## Further Information

- [www.inficon.com](http://www.inficon.com)  
Instruction sheet  
Bayard Alpert Pirani Gauge BPG400  
tima03e1  
INFICON AG, LI-9496 Balzers, Liechtenstein
- [www.inficon.com](http://www.inficon.com)  
Instruction manual  
Bayard Alpert Pirani Gauge BPG400, BPG400-SD, BPG400-SP, BPG400-SR  
tima03e1  
INFICON AG, LI-9496 Balzers, Liechtenstein
- [www.inficon.com](http://www.inficon.com)  
Communication protocol  
DeviceNet™ BPG400-SD  
tira03e1  
INFICON AG, LI-9496 Balzers, Liechtenstein
- [www.inficon.com](http://www.inficon.com)  
Communication protocol  
Profibus BPG400-SP  
tira33d1  
INFICON AG, LI-9496 Balzers, Liechtenstein
- [www.inficon.com](http://www.inficon.com)  
("Semiconductor and Vacuum coating processes, Vacuum Gauges")  
Product descriptions and downloads  
INFICON AG, LI-9496 Balzers, Liechtenstein
- [www.odva.org](http://www.odva.org)  
Open DeviceNet Vendor Association, Inc.  
"DeviceNet™ Specifications"
- [www.profibus.com](http://www.profibus.com)  
Profibus user organisation
- European Standard for DeviceNet EN 50325
- European Standard for Profibus EN 50170



LI-9496 Balzers  
Liechtenstein  
Tel +423 / 388 3111  
Fax +423 / 388 3700  
reachus@inficon.com  
www.inficon.com