

Capacitance Diaphragm Gauge

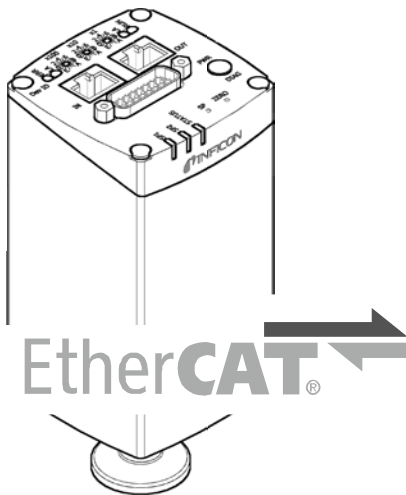



Edge™ CDG025D2



Operating Manual
Incl. EC Declaration of Conformity

Product Identification

In all communications with INFICON, please specify the information given on the product nameplate. For convenient reference copy that information into the space provided below.

INFICON AG, LI-9496 Balzers		 
Model:.....		
PN:.....	  	
SN:.....		
.....VDC;.....W		3103457

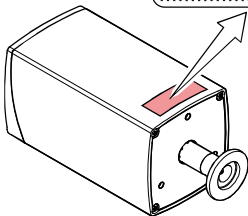

Validity

This document applies to products of the Edge™ CDG025D2 series.

Part numbers of standard products are indicated below. OEM products have other part numbers and different parameter settings (e.g. factory setting of setpoint) as defined in the corresponding ordering information.

3CB5-661-23G0

Filter	0	Standard
	B	P control
Interface	8	EtherCAT ^{*)}
	G	EtherCAT ^{**)}
Flange	1	DN 16 ISO-KF
	3	DN 16 CF-R
	9	½" tube
	C	4 VCR male
	D	4 VCR female
	E	8 VCR female
Unit	5	Torr (x 133 Pa; x 1.3 mbar)
	6	mbar (x 100 Pa)
Measurement range (F.S.)	3	0,1
	4	0,25
	5	0,5
	6	1
	7	2
	8	5
	9	10
	A	20
	B	50
	C	100
	D	200
E	500	
F	1000 (Torr only)	
G	1100 (mbar only)	

^{*)} ETG.5003.2080 S (R) V1.0.0

^{**)} ETG.5003.2080 S (R) V1.3.0

The part number (PN) can be taken from the product nameplate. If not indicated otherwise in the legends, the illustrations in this document correspond to gauges with DN 16 ISO-KF vacuum connection. They apply to the other gauges by analogy. We reserve the right to make technical changes without prior notice.

Intended Use

The Capacitance Diaphragm Gauges of the CDG025D2 series are intended for absolute pressure measurement of gases in their respective pressure ranges (→  2). They are clean room compliant and double protected against contamination.

The gauges belong to the Edge™ family and can be operated in connection with an INFICON Vacuum Gauge Controller (VGC series) or another appropriate controller.

Functional Principle

A ceramic diaphragm is deflected by pressure. The deflection is measured capacitively and converted into an analog linear output signal by the digital electronics.

The output signal is independent of the gas type.

Trademarks

Edge™ INFICON GmbH
VCR® Swagelok Marketing Co.

Patents

EP 1070239 B1, 1040333 B1

US Patents 6528008, 6591687, 7107855, 7140085



Scope of Delivery

- 1x gauge in clean room packaging
- 1x pin for adjusting settings via buttons
- 1x Calibration Test Report
- 1x Operating Manual German
- 1x Operating Manual English

Contents

Product Identification	2
Validity	2
Intended Use	4
Functional Principle	4
Trademarks	4
Patents	4
Scope of Delivery	5
1 Safety	8
1.1 Symbols Used	8
1.2 Personnel Qualifications	8
1.3 General Safety Instructions	9
1.4 Liability and Warranty	9
2 Technical Data	10
3 Installation	16
3.1 Vacuum Connection	16
3.2 Power Connection	19
3.2.1 D-sub, 15-pin Connector	20
3.2.2 EtherCAT Connector	21
4 Operation	22
4.1 Status Indication	22
4.2 Zeroing the Gauge	23
4.2.1 <ZERO> Adjustment	24
4.3 Switching Functions	28
4.4 Activating the Factory Setting (Factory Reset)	31
4.5 Diagnostic Port (RS232C Interface)	32
4.6 EtherCAT Operation	33
5 Deinstallation	34
6 Maintenance, Repair	35
7 Returning the Product	36
8 Disposal	37
9 Accessories	38

Further Information	38
ETL Certification	40
EC Declaration of Conformity	41

For cross-references within this document, the symbol (→  XY) is used, for cross-references to further documents, listed under "Further Information", the symbol (→  [Z]).

1 Safety

1.1 Symbols Used



DANGER

Information on preventing any kind of physical injury.



WARNING

Information on preventing extensive equipment and environmental damage.



Caution

Information on correct handling or use. Disregard can lead to malfunctions or minor equipment damage.



Notice



Labeling

1.2 Personnel Qualifications



Skilled personnel

All work described in this document may only be carried out by persons who have suitable technical training and the necessary experience or who have been instructed by the end-user of the product.

1.3 General Safety Instructions

- Adhere to the applicable regulations and take the necessary precautions for the process media used.
Consider possible reactions with the product materials.
- Adhere to the applicable regulations and take the necessary precautions for all work you are going to do and consider the safety instructions in this document.
- Before beginning to work, find out whether any vacuum components are contaminated. Adhere to the relevant regulations and take the necessary precautions when handling contaminated parts.

Communicate the safety instructions to all other users.

1.4 Liability and Warranty

INFICON assumes no liability and the warranty becomes null and void if the end-user or third parties

- disregard the information in this document
- use the product in a non-conforming manner
- make any kind of interventions (modifications, alterations etc.) on the product
- use the product with accessories not listed in the product documentation.

The end-user assumes the responsibility in conjunction with the process media used.



Gauge failures due to contamination are not covered by the warranty.

2 Technical Data

Measurement range	→ "Validity"
Accuracy ¹⁾	
≥1 Torr/mbar (F.S.)	0.20% of reading
0.25 Torr/mbar (F.S.)	0.25% of reading
0.1 Torr/mbar (F.S.)	0.50% of reading
Temperature effect on zero	
≥10 Torr/mbar (F.S.)	0.0050% F.S./ °C
1 / 2 Torr/mbar (F.S.)	0.015% F.S./ °C
0.1 / 0.25 Torr/mbar (F.S.)	0.020% F.S./ °C
Temperature effect on span	
≥1 Torr/mbar (F.S.)	0.01% of reading / °C
0.1 / 0.25 Torr/mbar (F.S.)	0.03% of reading / °C
Resolution	0.003% F.S.
Gas type dependence	none
<hr/>	
Output signal analog (measuring signal)	
Voltage range	-5 ... +10.24 V (limited to +10.24 V)
Measuring range	0 ... +10 V
Relationship voltage-pressure	linear
Output impedance	0 Ω (short-circuit proof)
Loaded impedance	>10 kΩ
Response time ²⁾	
≥0.25 Torr/mbar (F.S.)	30 ms
0.1 Torr/mbar (F.S.)	130 ms
<hr/>	
Gauge identification	Resistance 13.2 kΩ refer- enced to supply common (Voltage at pin 10 ≤5 V)
<hr/>	

¹⁾ Non-linearity, hysteresis, repeatability in the calibrated range at 25 °C ambient operating temperature without temperature effects after operation of 2 h.

²⁾ Increase 10 ... 90 % F.S.R.

Remote Zero Adjust	digital input for zero adjustment with external switching contact (→  24)
External switching contact Pulse	30 V (dc) / <5 mA (dc) >1 s ... <5 s
Switching functions	SP1, SP2
Setting range	0 ... +10 V
Hysteresis	1% F.S.
Relay contact	30 V (dc) / ≤0.5 A (dc) floating (NO)
closed	at low pressure (LED is lit)
open	at high pressure (LED is off)
Switching time	≤50 ms
Status relay	
Relay contact	30 V (dc) / ≤0.5 A (dc) connected to supply common (pin 5)
closed	measurement mode warning
open	no supply voltage error
RS232C interface	
Transmission rate	9600 baud
Data format	binary 8 data bits one stop bit no parity bit no handshake → "Power Connection"
For further information on the RS232C interface →  [5].	
Diagnostic port	Jack connector, 2.5 mm, 3-pin

EtherCAT interface

Specification, data format,
communication protocol

3CB5-xxx-238x

→  [8], [9]

3CB5-xxx-23Gx

→  [10], [11]

Data rate

100 Mbps

Note address

explicit device identification

Physical layer

100Base-Tx (IEEE 802.3)

EtherCAT connector

2xRJ45, 8-pin, socket
input and output

Cable

8-pin, shielded, Ethernet
Patch Cable (CAT5e quality
or higher)

Cable length

≤100 m

For further information on the EtherCAT interface →  [6], [7].

Supply





DANGER

The gauge may only be connected to power supplies, instruments or control devices that conform to the requirements of a grounded protective extra-low voltage (PELV) and limited power source (LPS), Class 2. The connection to the gauge has to be fused ³⁾.

Supply voltage
at the gauge

Class 2 / LPS
+14 ... +30 V (dc) or
±15 V (±5%)

Ripple

≤1 V_{pp}

Current consumption

<500 mA
(max. starting current)

Power consumption
(depending on supply voltage)

≤3 W

³⁾ INFICON controllers fulfill this requirement.

Fuse required ³⁾	1 AT (slow), automatic reset (Polyfuse)
The gauge is protected against reverse polarity of the supply voltage and overload.	
Electrical connection	D-sub 15-pin, male
Sensor cable	15-pin plus shielding
Cable length	
Supply voltage 15 V	≤ 4 m (0.14 mm ² /conductor) ≤ 7 m (0.25 mm ² /conductor)
Supply voltage 24 V	≤20 m (0.14 mm ² /conductor) ≤35 m (0.25 mm ² /conductor)
Supply voltage 30 V	≤40 m (0.14 mm ² /conductor) ≤70 m (0.25 mm ² /conductor)
For longer cables, larger conductor cross-sections are required ($R_{\text{cable}} \leq 1.0 \Omega$).	
Grounding concept	→ "Power Connection"
Materials exposed to vacuum	
Flange, tube	stainless steel AISI 316L
Sensor and diaphragm	ceramics ($\text{Al}_2\text{O}_3 \geq 99.5\%$)
Internal volume	≤4.2 cm ³
Admissible pressure (absolute)	
≥200 Torr/mbar (F.S.)	4 bar 400 kPa
1 ... 100 Torr/mbar (F.S.)	2.6 bar 260 kPa
0.1 / 0.25 Torr/mbar (F.S.)	1.3 bar 130 kPa
Bursting pressure (absolute)	6 bar 600 kPa
Admissible temperatures	
Storage	-40 °C ... +65 °C
Operation	+5 °C ... +50 °C
Bakeout (not in operation)	≤110 °C at the flange
Relative humidity	≤80% at temperatures ≤+31 °C decreasing to 50% at +40°C
Use	indoors only, altitude up to 2000 m NN
Degree of protection	IP 40

Dimensions [mm]

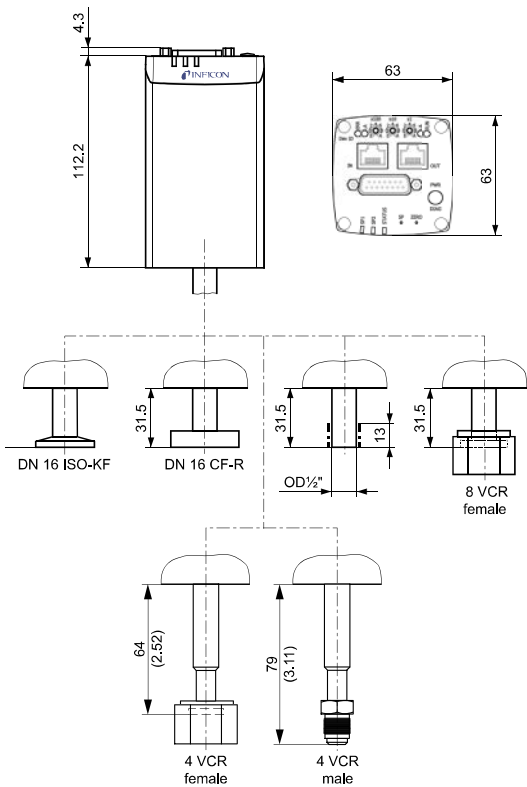

Weight

<650 g

Analog Measurement Signal vs. Pressure

Pressure p

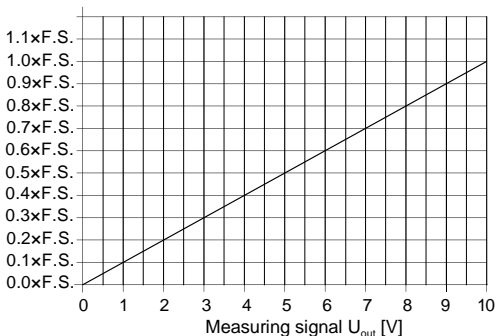

$$p = (U_{\text{out}} / 10 \text{ V}) \times p (\text{F.S.})$$

Conversion Torr \leftrightarrow Pascal

	Torr	mbar ⁴⁾	Pa ⁴⁾
c	1.00	1013.25 / 760 = 1.3332...	101325 / 760 = 133.3224...

Example: Gauge with 10 Torr F.S.
Measurement signal $U_{\text{out}} = 6 \text{ V}$

$$\begin{aligned} p &= (6 \text{ V} / 10 \text{ V}) \times 10 \text{ Torr} \\ &= 0.6 \times 10 \text{ Torr} = \mathbf{6 \text{ Torr}} \end{aligned}$$

⁴⁾ Source: NPL (National Physical Laboratory)
Guide to the Measurement of Pressure and Vacuum, ISBN 0904457x /
1998

3 Installation



WARNING



Fragile components

The ceramic sensor may be damaged by impacts. Do not drop the product and prevent shocks and impacts.

3.1 Vacuum Connection



DANGER



Overpressure in the vacuum system >1 bar
Injury caused by released parts and harm caused by escaping process gases can result if clamps are opened while the vacuum system is pressurized. Do not open any clamps while the vacuum system is pressurized. Use the type clamps which are suited to overpressure.



DANGER



Overpressure in the vacuum system >2.5 bar
KF flange connections with elastomer seals (e.g. O-rings) cannot withstand such pressures. Process media can thus leak and possibly damage your health. Use O-rings provided with an outer centering ring.

DANGER

Protective ground

Products that are not correctly connected to ground can be extremely hazardous in the event of a fault.

Electrically connect the gauge to the grounded vacuum chamber. This connection must conform to the requirements of a protective connection according to EN 61010:

- CF and VCR flanges fulfill this requirement.
- For gauges with a KF flange, use a conductive metallic clamping ring.
- For gauges with a ½" tube, take appropriate measures to fulfill this requirement.

Caution

Vacuum component

Dirt and damages impair the function of the vacuum component.

When handling vacuum components, take appropriate measures to ensure cleanliness and prevent damages.

Caution

Dirt sensitive area

Touching the product or parts thereof with bare hands increases the desorption rate.

Always wear clean, lint-free gloves and use clean tools when working in this area.



Mount the gauge so that no vibrations occur. The gauge may be mounted in any orientation. To keep condensates and particles from getting into the measuring chamber preferably choose a horizontal to upright position and possibly use a seal with a centering ring and filter. If adjustment should be possible after the gauge has been installed, be sure to install it so that the buttons can be accessed with a pin (→ 23).

Remove the protective lid and connect the product to the vacuum system.

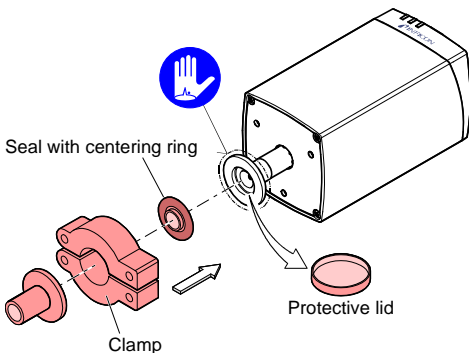

Keep the protective lid.

3.2 Power Connection



Make sure the vacuum connection is properly made (→ 16).



DANGER

The gauge may only be connected to power supplies, instruments or control devices that conform to the requirements of a grounded protective extra-low voltage (PELV) and limited power source (LPS), Class 2. The connection to the gauge has to be fused ⁵⁾.



Ground loops, differences of potential, or EMC problems may affect the measurement signal. For optimum signal quality, please do observe the following notes:

- Use an overall metal braided shielded cable. The connector must have a metal case.
- Connect the cable shield to ground at one side via the connector case. Make sure the connector case has direct contact to the cable's shield on its whole circumference. Do not connect the other side of the shield.
- Connect the supply common with protective ground directly at the power.
- Use differential measurement input (signal common and supply common conducted separately).
- Potential difference between supply common and housing ≤ 18 V (overvoltage protection).

⁵⁾ INFICON controllers fulfill this requirement.

3.2.1 D-sub, 15-pin Connector

If no sensor cable is available, make one according to the following diagram. Connect the sensor cable (cable length and conductor cross-sections → 13).

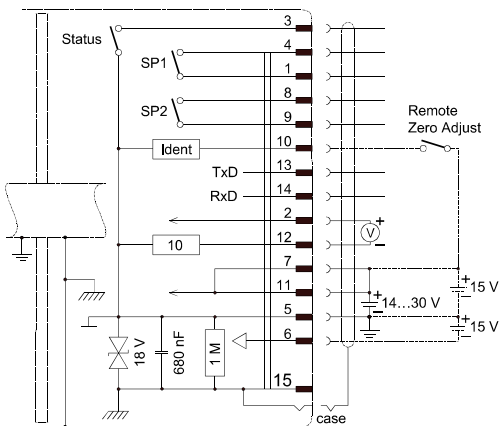

Pin 1,4	Relay SP1, closing contact
Pin 2	Signal output (measurement signal) or thresholds SP1/2
Pin 3	Status
Pin 5	Supply common
Pin 6	Supply (-15 V)
Pin 7, 11	Supply (+14 ... +30 V or +15 V)
Pin 8, 9	Relay SP2, closing contact
Pin 10	Gauge identification or Remote Zero Adjust
Pin 12	Signal common
Pin 13	RS232, TxD
Pin 14	RS232, RxD
Pin 15	Housing (chassis ground)
case	Connector case

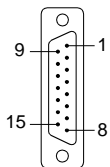

D-sub,
15 pin
female
soldering side

3.2.2 EtherCAT Connector



EtherCAT is a communications interface. It is powered via the sensor cable.

If no EtherCAT cables are available, make them according to the following diagram. Connect the EtherCAT cables.



FCC68, 8-pin, soldering side

Pin 1	TD+	Transmission data +
Pin 2	TD-	Transmission data -
Pin 3	RD+	Receive data +
Pin 6	RD-	Receive data -
Pin 4, 5, 7 and 8: n.c.		

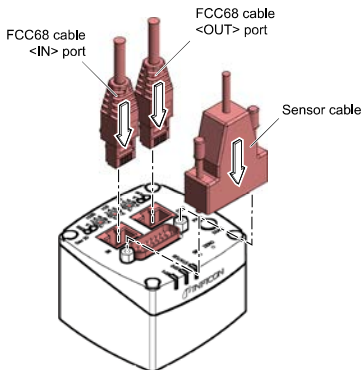

4 Operation



Put the gauge into operation. If you are using an INFICON controller of the VGC40x series, define the measurement range (→  [1], [2], [3]).

Warm-up time

- for general purpose reading (within specifications) >¼ hour
- for zero adjustment and precision measurement >2 hours



If the gauge is used for fast downstream pressure control we recommend setting its signal filter to "fast".

The filter can be set via the RS232C interface, the diagnostic port (→  [5]) or via EtherCAT (→  [6], [7]).

4.1 Status Indication

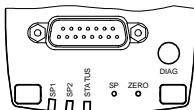

LED	LED status	Meaning
<STATUS>	off	no supply voltage
	lit solid green	measurement mode
	blinking green short blinks	warning, over/underrange
	lit solid red	error
<SP1>	lit green green	$p \leq$ setpoint 1
	blinking green	waiting for setpoint 1 input
	off	$p >$ setpoint 1
<SP2>	lit solid green	$p \leq$ setpoint 2
	blinking green	waiting for setpoint 2 input
	off	$p >$ setpoint 2

EtherCAT LEDs →  [6], [7]

4.2 Zeroing the Gauge

The gauge is factory calibrated while "standing upright" (→ "Calibration Test Report").



We recommend performing a zero adjustment, when the gauge is operated for the first time.

Due to long time operation or contamination, a zero drift could occur and zero adjustment may become necessary.

For adjusting the zero, operate the gauge under the same constant ambient conditions and in the same mounting orientation as normally.

The output signal (measuring signal) is depending on the mounting orientation. The signal difference between the vertical and horizontal mounting orientation is:

F.S.	$\Delta U / 90^\circ$
1000 Torr/mbar	$\approx 2 \text{ mV}$
100 Torr/mbar	$\approx 10 \text{ mV}$
10 Torr/mbar	$\approx 50 \text{ mV}$
1 Torr/mbar	$\approx 300 \text{ mV}$
0.1 Torr/mbar	$\approx 1.8 \text{ V}$



If the gauge is operated via a controller, the zero of the whole measuring system has to be adjusted on the controller: first, adjust the zero of the gauge and then, the zero of the controller.

4.2.1 <ZERO> Adjustment



The zero can be adjusted via

- the <ZERO> button on the gauge,
- the diagnostic port (→ [5]),
- the EtherCAT interface (→ [6], [7]),
- the digital input "Remote Zero": Apply the supply voltage to pin 10, pulse → 11,
- the RS232C interface (→ [5]),
- an INFICON Vacuum Gauge Controller (VGC series).



While the gauge is under atmospheric pressure, the zeroing function is locked in order for operating errors to be prevented.

1

Evacuate the gauge to a pressure according to the table below:

F.S.	Recommended final pressure for zero adjustment		
1100 mbar	–	<7×10 ⁰ hPa	<7×10 ⁻² mbar
1000 Torr	<5×10 ⁻² Torr	<7×10 ⁰ hPa	–
500 Torr/mbar	<2.5×10 ⁻² Torr	<3×10 ⁰ hPa	<3×10 ⁻² mbar
200 Torr/mbar	<10 ⁻² Torr	<1×10 ⁰ hPa	<1×10 ⁻² mbar
100 Torr/mbar	<5×10 ⁻³ Torr	<7×10 ⁻¹ hPa	<7×10 ⁻³ mbar
50 Torr/mbar	<2.5×10 ⁻³ Torr	<3×10 ⁻¹ hPa	<3×10 ⁻³ mbar
20 Torr/mbar	<10 ⁻³ Torr	<1×10 ⁻¹ hPa	<1×10 ⁻³ mbar
10 Torr/mbar	<5×10 ⁻⁴ Torr	<7×10 ⁻² hPa	<7×10 ⁻⁴ mbar
5 Torr/mbar	<2.5×10 ⁻⁴ Torr	<3×10 ⁻² hPa	<3×10 ⁻⁴ mbar
2 Torr/mbar	<10 ⁻⁴ Torr	<1×10 ⁻² hPa	<1×10 ⁻⁴ mbar
1 Torr/mbar	<5×10 ⁻⁵ Torr	<7×10 ⁻³ hPa	<7×10 ⁻⁵ mbar
0.5 Torr/mbar	<2.5×10 ⁻⁵ Torr	<3×10 ⁻³ hPa	<3×10 ⁻⁵ mbar
0.25 Torr/mbar	<10 ⁻⁵ Torr	<1×10 ⁻³ hPa	<1×10 ⁻⁵ mbar
0.1 Torr/mbar	<5×10 ⁻⁶ Torr	<7×10 ⁻⁴ hPa	<7×10 ⁻⁶ mbar

If the final pressure is too high for zero adjustment (>25% of the F.S.), the zero cannot be reached and the <STATUS> LED blinks green. If this is the case, activate the factory setting and adjust the zero again (→ 31).

- 2 Operate the gauge for at least 2 hours under constant ambient conditions (until the signal is stable).
- 3 Briefly press the <ZERO> button with a pin (max. $\varnothing 1.1$ mm). The zero adjustment runs automatically. The <STATUS> LED blinks until the adjustment (duration ≤ 8 s) is completed.

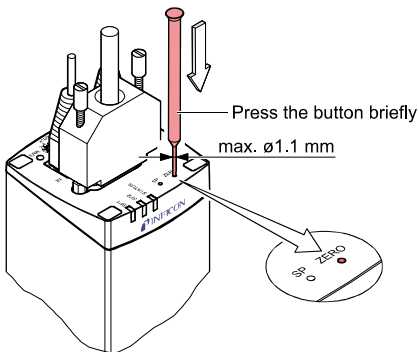

 After zero adjustment, the gauge automatically returns to the measurement mode.

The <STATUS> LED blinks green if

- the signal output is negative (< -20 mV) when the final pressure has been attained
- the zero adjustment has failed.

4.2.2 <ZERO> Adjustment with Ramp Function

The ramp function allows to adjust the zero at a known reference pressure within the measurement range of the gauge.



It also permits to adjust an offset of the characteristic curve in order to

- compensate for the offset of the measuring system or
- obtain a slightly positive zero for a 0 ... 10 V AD converter.

The offset should not exceed 2% of the F.S. (+200 mV). At a higher positive offset, the upper limit of the measurement range is exceeded.



Zero adjustment using the ramp function can be performed via

- the <ZERO> button on the gauge,
- the diagnostic port (→  [5]),
- the EtherCAT interface (→  [6], [7]),
- the RS232C interface (→  [5]).



Recommended procedure for adjusting the offset of a measuring system: → Notice  23.

- 1** Operate the gauge for at least 2 hours under constant ambient conditions (until the signal is stable).
- 2** Push the <ZERO> button with a pin (max. $\varnothing 1.1$ mm) and keep it depressed. The <STATUS> LED starts blinking. After 5 s, the zero adjustment value, starting at the current output value, keeps continually changing (ramp) until the button is released or until the setting limit (max. 25% F.S.) is reached. The corresponding output signal is delayed by about 1 s.

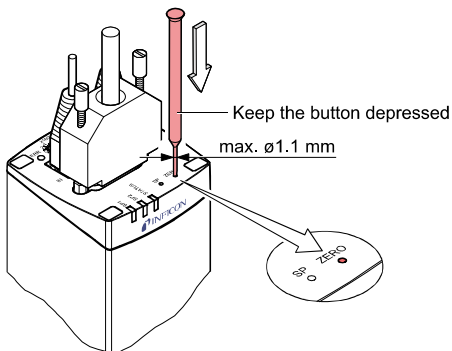

3 Push the <ZERO> button again:

Fine adjustment within 0...3 s:	the zero adjustment value changes by one unit (push <ZERO> button in intervals of 1 s)
Change of direction within 3...5 s:	the zero adjustment changes its direction (the blinking frequency of the <STATUS> LED changes briefly)



If the <ZERO> button is released for more than 5 s, the gauge returns to the measurement mode.

The <STATUS> LED blinks green if the signal output is negative (< -20 mV).

4.3 Switching Functions

The two switching functions can be set to any pressure within the measurement range of the gauge (→ 15).

The current setpoint setting

- is output at the D-sub connector instead of the measurement signal (→ 20) and can be measured with a voltmeter after the <SP> button is pressed, or
- can be read/written via EtherCAT, diagnostic port and the RS232C interface.

If the pressure is lower than the setpoint, the corresponding LED (<SP1> or <SP2>) is lit solid and the corresponding relay (→ 20) is energized.

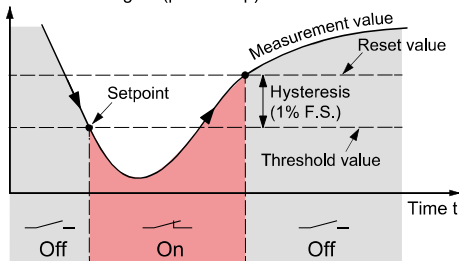

Measurement signal (pressure p)



4.3.1 Adjusting the Setpoints



The setpoints can be adjusted via

- the buttons on the gauge,
- the diagnostic port (→  [5]),
- the EtherCAT interface (→  [6], [7]),
- the RS232C interface (→  [5]).



DANGER



Malfunction

If processes are controlled via the signal output, keep in mind that by pushing the <SP> button the measurement signal is suppressed and the corresponding threshold value is output instead. This can cause malfunctions.

Push the <SP> button only if you are sure that no malfunction will cause.

Adjusting Setpoint <1>



Push the <SP> button with a pin (max. $\varnothing 1.1$ mm). The gauge changes to the switching function mode and outputs the current threshold value at the measurement value output for about 10 s (LED <1> blinks).

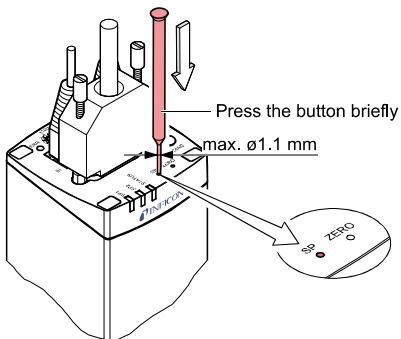

- 2** For changing the threshold value, push the <ZERO> button and keep it depressed. The threshold keeps changing from the current value (ramp) until the button is released or until the limit of the setting range is reached.

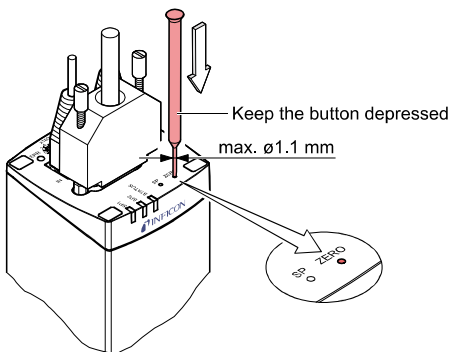

- 3** Push the <ZERO> button again:

Fine adjustment within 0...3 s:	the zero adjustment value changes by one unit
Change of direction within 3...5 s:	the zero adjustment changes its direction (the blinking frequency of the <STATUS> LED changes briefly)



If the <ZERO> button is released for more than 5 s, the gauge returns the measurement mode.



The upper threshold is automatically set 1% F.S. above the lower one (hysteresis).

Adjusting Setpoint <2>

Push the <SP> button twice (the LED <2> blinks). The adjustment procedure is the same as for setpoint <1>.

4.4 Activating the Factory Setting (Factory Reset)

All user defined parameters (e.g. zero, filter) are restored to their default values.



Loading of the default parameters is irreversible.

Loading the default parameters:

- 1** Put the gauge out of operation.
- 2** Keep the <ZERO> button depressed for at least 5 s while the gauge is being put into operation (Power ON).

4.5 Diagnostic Port (RS232C Interface)

The diagnostic port <DIAG> permits to output the pressure reading and all status information and to enter all settings at the same time (→  [5]).

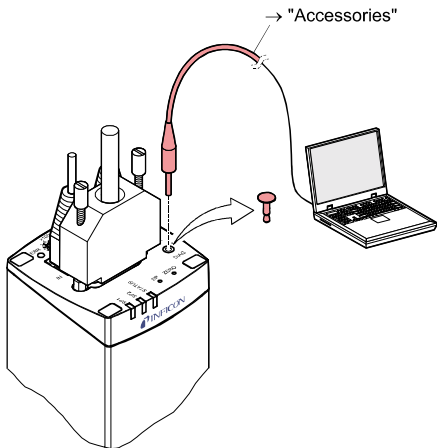

4.6 EtherCAT Operation



Caution



Data transmission errors

Any attempt to simultaneously operate the gauge via the EtherCAT interface and the RS232 interface or the diagnostic port causes data transmission errors.

Therefore the gauge must not be operated simultaneously via the EtherCAT interface and the RS232 interface or the diagnostic port.

For operating the gauge via EtherCAT, prior installation of the device specific ESI file is required on the bus master side. This file can be downloaded from our website (www.inficon.com).

Explicit Device Address Setting (default 00_{hex})

During device initialization, the device address switches are read by the device firmware. This device address is supported to the master as Explicit Device Identification.

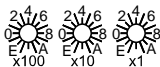

The explicit device address is set in hexadecimal form (00 ... FFF_{hex}) via the <x100>, <x10> and <x1> switches.

Example: Device address = 0xDDD (dec 3549):
 $0x100 * 0xD$ (dec 3328) + $0x10 * 0xD$ (dec 208) + $0x1 * 0xD$ (dec 13)



Status LED

LEDs on the gauge inform on the gauge status and the current EtherCAT status (→ [\[6\]](#), [\[7\]](#)).

5 Deinstallation



WARNING



Fragile components

The ceramic sensor may be damaged by impacts. Do not drop the product and prevent shocks and impacts.



DANGER



Contaminated parts

Contaminated parts can be detrimental to health and environment.

Before beginning to work, find out whether any parts are contaminated. Adhere to the relevant regulations and take the necessary precautions when handling contaminated parts.



Caution



Vacuum component

Dirt and damages impair the function of the vacuum component.

When handling vacuum components, take appropriate measures to ensure cleanliness and prevent damages.

**Caution**

Dirt sensitive area

Touching the product or parts thereof with bare hands increases the desorption rate.

Always wear clean, lint-free gloves and use clean tools when working in this area.

- 1** Vent the vacuum system.
- 2** Put the gauge out of operation.
- 3** Unfasten the lock screws and disconnect the sensor cable and the EtherCAT cables.
- 4** Remove the gauge from the vacuum system and install the protective lid.

6 Maintenance, Repair

Under clean operating conditions, the product requires no maintenance.



Gauge failures due to contamination are not covered by the warranty.

We recommend checking the zero at regular intervals (→  24).

INFICON assumes no liability and the warranty becomes null and void if any repair work is carried out by the end-user or third parties.

7 Returning the Product



WARNING

Forwarding contaminated products

Contaminated products (e.g. radioactive, toxic, caustic or microbiological hazard) can be detrimental to health and environment.

Products returned to INFICON should preferably be free of harmful substances. Adhere to the forwarding regulations of all involved countries and forwarding companies and enclose a duly completed declaration of contamination^{*)}.

^{*)} Form under www.inficon.com

Products that are not clearly declared as "free of harmful substances" are decontaminated at the expense of the customer. Products not accompanied by a duly completed declaration of contamination are returned to the sender at his own expense.

8 Disposal



DANGER



Contaminated parts

Contaminated parts can be detrimental to health and environment.

Before beginning to work, find out whether any parts are contaminated. Adhere to the relevant regulations and take the necessary precautions when handling contaminated parts.



WARNING



Substances detrimental to the environment

Products or parts thereof (mechanical and electric components, operating fluids etc.) can be detrimental to the environment.

Dispose of such substances in accordance with the relevant local regulations.

Separating the components

After disassembling the product, separate its components according to the following criteria:

- Contaminated components

Contaminated components (radioactive, toxic, caustic or biological hazard etc.) must be decontaminated in accordance with the relevant national regulations, separated according to their materials, and disposed of.
- Other components

Such components must be separated according to their materials and recycled.

9 Accessories

	Ordering number
Communication adapter (2 m) ⁶⁾	303-333

Further Information

-  [1] Operating Manual
 Vacuum Gauge Controller VGC032
 tinb02d1 (German)
 tinb02e1 (English)
 INFICON AG, LI-9496 Balzers, Liechtenstein

-  [2] Operating Manual
 Single-Channel Controller VGC401
 tinb01d1 (German)
 tinb01e1 (English)
 INFICON AG, LI-9496 Balzers, Liechtenstein

-  [3] Operating Manual
 Two- & Three-Channel Measurement and Control Unit
 VGC402, VGC403
 tinb07d1 (German)
 tinb07e1 (English)
 INFICON AG, LI-9496 Balzers, Liechtenstein

⁶⁾ The diagnostic software (Windows NT, XP) can be downloaded from our website.

- [4] Operating Manual
One-, Two- & Three-Channel Measurement and Control
Unit VGC501, VGC502, VGC503
tina96d1 (German)
tina96e1 (English)
INFICON AG, LI-9496 Balzers, Liechtenstein

- [5] www.inficon.com
Communication Protocol
RS232C Interface
tira49d1 (German)
tira49e1 (English)
INFICON AG, LI-9496 Balzers, Liechtenstein

- [6] www.inficon.com
Communication Protocol
EtherCAT CDGxxxDxx (ETG.5003.2080 S (R) V1.0.0)
tira68e1
INFICON AG, LI-9496 Balzers, Liechtenstein

- [7] www.inficon.com
Communication Protocol
EtherCAT CDGxxxDxx (ETG.5003.2080 S (R) V1.3.0)
tirb45e1
INFICON AG, LI-9496 Balzers, Liechtenstein

- [8] ETG.5003.1 S (R) V1.0.0: Semiconductor Device profile
– Part 1: Common Device Profile (CDP)

- [9] ETG.5003.2080 S (R) V1.0.0: Semiconductor Device
profile – Part 2080: Specific Device Profile (SDP):
Vacuum Pressure Gauge

- [10] ETG.5003.1 S (R) V1.1.0: Semiconductor Device profile
– Part 1: Common Device Profile (CDP)

- [11] ETG.5003.2080 S (R) V1.3.0: Semiconductor Device
profile – Part 2080: Specific Device Profile (SDP):
Vacuum Pressure Gauge

ETL Certification

Intertek
3103457

ETL LISTED

The product Edge™ CDG025D2

- conforms to the UL Standard
UL 61010-1
- is certified to the CSA Standard
CSA C22.2 # 61010-1

EC Declaration of Conformity



We, INFICON, hereby declare that the equipment mentioned below complies with the provisions of the Directive relating to electromagnetic compatibility 2014/30/EU and the Directive on the restriction of the use of certain hazardous substances in electrical and electronic equipment 2011/65/EU.

Products

Capacitance Diaphragm Gauge
Edge™ CDG025D2

Standards

Harmonized and international/national standards and specifications:

- EN 61000-6-2:2005 (EMC: generic immunity standard)
- EN 61000-6-3:2007 + A1:2011 (EMC: generic emission standard)
- EN 61010-1:2010 (Safety requirements for electrical equipment for measurement, control and laboratory use)
- EN 61326:2013, Group 1, Class B (EMC requirements for electrical equipment for measurement, control and laboratory use)

Manufacturer / Signatures

INFICON AG, Alte Landstraße 6, LI-9496 Balzers

20 July 2016

20 July 2016

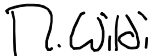
Dr. Bernhard Andreaus
Director Product Evolution

Michael Wildi
Product Manager

Notes

Notes

Original: German tinb28d1-a (2019-03)



ti nb28e1-a



LI-9496 Balzers
Liechtenstein
Tel +423 / 388 3111
Fax +423 / 388 3700
reachus@inficon.com

www.inficon.com