

Operating Manual  
Incl. EU Declaration of Conformity

**SKY<sup>®</sup> CDG025D**  
**SKY<sup>®</sup> CDG025D-S**  
Capacitance Diaphragm Gauge

# Table of Contents

<b>1</b>	<b>General</b> .....	<b>4</b>
1.1	Product Identification .....	4
1.2	Validity .....	4
1.3	Intended Use.....	6
1.4	Functional Principle.....	6
1.5	Trademarks.....	6
1.6	Patents.....	6
<b>2</b>	<b>Safety</b> .....	<b>7</b>
2.1	Symbols Used.....	7
2.2	Personnel Qualifications .....	7
2.3	General Safety Instructions.....	8
2.4	Liability and Warranty .....	8
<b>3</b>	<b>Technical Data</b> .....	<b>9</b>
<b>4</b>	<b>Installation</b> .....	<b>14</b>
4.1	Vacuum Connection.....	14
4.2	Power Connection.....	17
<b>5</b>	<b>Operation</b> .....	<b>19</b>
5.1	Displays .....	19
5.2	Zeroing the Gauge.....	20
5.2.1	<ZERO> Adjustment.....	20
5.2.2	<ZERO> Adjustment with Ramp Function.....	22
5.3	Switching Functions (CDG025D-S only).....	24
5.3.1	Adjusting the Setpoints.....	24
5.4	Activating the Factory Setting (Factory Reset) .....	27
<b>6</b>	<b>Deinstallation</b> .....	<b>27</b>
<b>7</b>	<b>Maintenance, Repair</b> .....	<b>28</b>
<b>8</b>	<b>Returning the Product</b> .....	<b>29</b>
<b>9</b>	<b>Disposal</b> .....	<b>29</b>
	<b>Further Information</b> .....	<b>31</b>
	<b>ETL Certification</b> .....	<b>32</b>
	<b>EU Declaration of Conformity</b> .....	<b>33</b>
	<b>UKCA Declaration of Conformity</b> .....	<b>34</b>

Symbol for cross-references within this document:

→  XY

Symbol for references to literature list:

→  [Z]

# 1 General

## 1.1 Product Identification

In all communications with INFICON, please specify the information on the product nameplate.

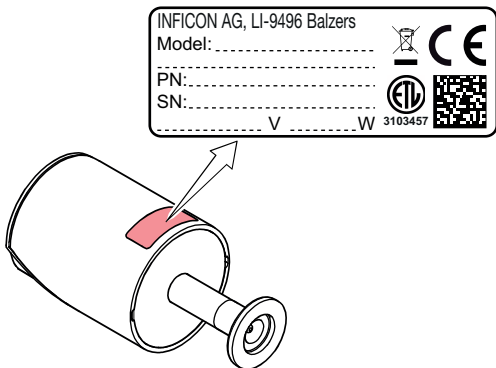

## 1.2 Validity

This document applies to products of the SKY® CDG025D and SKY® CDG025D-S series.

Part numbers of standard products are indicated below. OEM products have other part numbers and different parameter settings (e.g. factory setting of setpoint) as defined in the corresponding ordering information.

<b>3xx-x0x</b>	<u>Flange</u>	0 ⇒ ½" tube 1 ⇒ DN 16 ISO-KF 2 ⇒ DN 16 CF-R 3 ⇒ 8 VCR female 5 ⇒ 4 VCR female 7 ⇒ 4 VCR male
	<u>Switching function</u> <u>Unit</u>	Without switching function 0 ⇒ Torr (× 133 Pa; × 1.3 mbar) 2 ⇒ mbar (× 100 Pa)  With switching function 3 ⇒ Torr (× 133 Pa; × 1.3 mbar) 5 ⇒ mbar (× 100 Pa)
	<u>Full scale (FS)</u>	75 ⇒ 1000 (Torr only) 75 ⇒ 1100 (mbar only) 76 ⇒ 100 77 ⇒ 10 78 ⇒ 1 79 ⇒ 0.1 82 ⇒ 200 83 ⇒ 20 84 ⇒ 2 85 ⇒ 0.25 87 ⇒ 500

The part number (PN) can be taken from the product nameplate.

If not indicated otherwise in the legends, the illustrations in this document correspond to CDG025D-S gauges with the DN 16 ISO-KF vacuum connection. They apply to other gauges by analogy.

We reserve the right to make technical changes without prior notice.

All dimensions in mm.

### 1.3 Intended Use

The Capacitance Diaphragm Gauges of the SKY® CDG025D series are intended for absolute pressure measurement of gases in their respective pressure ranges.

The gauges belong to the SKY® Smart Sensors family and can be operated in connection with an INFICON Vacuum Gauge Controller (VGC series) or another appropriate controller.

### 1.4 Functional Principle

A ceramic diaphragm is deflected by pressure. The deflection is measured capacitively and converted into an analog linear output signal by the digital electronics.

The output signal is independent of the gas type.

### 1.5 Trademarks

SKY®      INFICON Holding AG  
VCR®      Swagelok Marketing Co.

### 1.6 Patents

EP 1070239 B1, 1040333 B1  
US Patents 6528008, 6591687, 7107855, 7140085

## 2 Safety

### 2.1 Symbols Used



#### **DANGER**

Information on preventing any kind of physical injury.



#### **WARNING**

Information on preventing extensive equipment and environmental damage.



#### **Caution**

Information on correct handling or use. Disregard can lead to malfunctions or minor equipment damage.



Notice

<...> Labeling

### 2.2 Personnel Qualifications



#### **Skilled personnel**

All work described in this document may only be carried out by persons who have suitable technical training and the necessary experience or who have been instructed by the end-user of the product.

## 2.3 General Safety Instructions

- Adhere to the applicable regulations and take the necessary precautions for the process media used.  
Consider possible reactions with the product materials.
- Adhere to the applicable regulations and take the necessary precautions for all work you are going to do and consider the safety instructions in this document.
- Before beginning to work, find out whether any vacuum components are contaminated. Adhere to the relevant regulations and take the necessary precautions when handling contaminated parts.

Communicate the safety instructions to all other users.

## 2.4 Liability and Warranty

INFICON assumes no liability and the warranty becomes null and void if the end-user or third parties

- disregard the information in this document
- use the product in a non-conforming manner
- make any kind of interventions (modifications, alterations etc.) on the product
- use the product with accessories not listed in the corresponding product documentation.

The end-user assumes the responsibility in conjunction with the process media used.

Gauge failures due to contamination are not covered by the warranty.



### 3 Technical Data

Measurement range	→ "Validity"
Accuracy <sup>1)</sup>	
≥1 Torr/mbar (FS)	0.20% of reading
0.25 Torr/mbar (FS)	0.25% of reading
0.1 Torr/mbar (FS)	0.50% of reading
Temperature effect on zero	
≥10 Torr/mbar (FS)	0.0050% FS/ °C
1 / 2 Torr/mbar (FS)	0.015% FS/ °C
0.1 / 0.25 Torr/mbar (FS)	0.020% FS/ °C
Temperature effect on span	
≥1 Torr/mbar (FS)	0.01% of reading / °C
0.1 / 0.25 Torr/mbar (FS)	0.03% of reading / °C
Resolution	0.003% FS
Gas type dependence	none
Output signal analog (measurement signal)	
Measurement range	0 ... +10 V
Voltage range	-5 ... +10.24 V
Voltage vs. pressure	linear
Output impedance	0 Ω (short-circuit proof)
Loaded impedance	>10 kΩ
Response time	
≥1 Torr/mbar (FS)	30 ms
≤0.25 Torr/mbar (FS)	130 ms
Identification	
Resistance $R_{ident}$	Resistance 13.2 kΩ referred to supply common

<sup>1)</sup> Non linearity, hysteresis, repeatability in the calibrated range at 23 °C ambient operating temperature without temperature effects after operation of 2 h.

Switching function	SP1, SP2
Setting range	0 ... +10 V
Hysteresis	1% FS
Relay contact	30 V (dc) / $\leq 0.5$ A (dc)
closed	floating (NO)
open	at low pressure (LED on)
Switching time	at high pressure (LED off)
	$\leq 50$ ms
RS232C interface	
Transmission rate	9600 Baud
Data format	binary, 8 data bits, one stop bit, no parity bit, no handshake
For further information on the RS232C interface →  [5]	

## Supply



### DANGER

The gauge may only be connected to power supplies, instruments or control devices that conform to the requirements of a grounded protective extra-low voltage (PELV) and limited power source (LPS), Class 2.

- The connection to the gauge has to be fused <sup>2)</sup>.

Supply voltage at the gauge	Class 2 / LPS
Ripple	+14 ... +30 V (dc)
	$\leq 1$ V <sub>pp</sub>
Current consumption (max. starting current)	<500 mA
Power consumption (depending on supply voltage)	$\leq 1$ W
Fuse to be connected <sup>2)</sup>	1 AT (slow), automatic re-set (Polyfuse)

<sup>2)</sup> INFICON controllers fulfill these requirements.

The gauge is protected against reverse polarity of the supply voltage.	
Receptacle	D-sub 15-pin, male
Sensor cable without switching functions with switching functions	9-pin plus shielding 13-pin plus shielding
Cable length	≤100 m (0.14 mm <sup>2</sup> /conductor)
For longer cables, larger conductor cross-sections are required ( $R_{\text{cable}} \leq 1.0 \Omega$ ).	
Grounding concept Vacuum flange–signal common Supply common–signal common	see "Power Connection" conducted separately; for differential measurement (10 $\Omega$ )
Materials exposed to vacuum Flange, tube Sensor and diaphragm Sensor–diaphragm connection Ceramics–metal connection	stainless steel AISI 316L ceramics (Al <sub>2</sub> O <sub>3</sub> ≥99.5%) glass ceramics solder AgTiCu-Hartlot, Vacon 70 (28% Ni, 23% Co, 49% Fe)
Internal volume	≤4.0 cm <sup>3</sup>
Leak rate	<1×10 <sup>-9</sup> mbar l/s
Admissible pressure (absolute) ≥200 Torr/mbar (FS) 1 ... 100 Torr/mbar (FS) 0.1 / 0.25 Torr/mbar (FS)	4 bar 2.6 bar 1.3 bar
Bursting pressure (absolute)	5 bar
Admissible temperature Storage Operation Bakeout (not in operation)	-40 °C ... +65 °C +5 °C ... +50 °C ≤110 °C at the flange
Relative humidity	≤80% at temperatures ≤+31 °C, decreasing to 50% at +40 °C

Use	indoors only, altitude up to 2000 m NN
Pollution degree	2
Degree of protection	IP30

### Dimensions [mm]

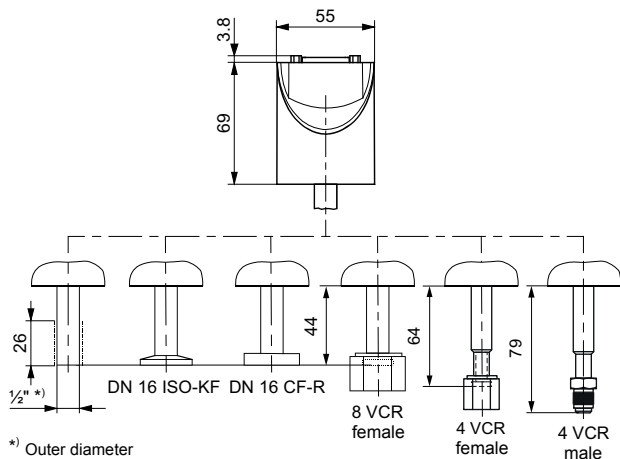

Weight	285 g ... 342 g
--------	-----------------

## Analog Measurement Signal vs. Pressure

Pressure  $p$

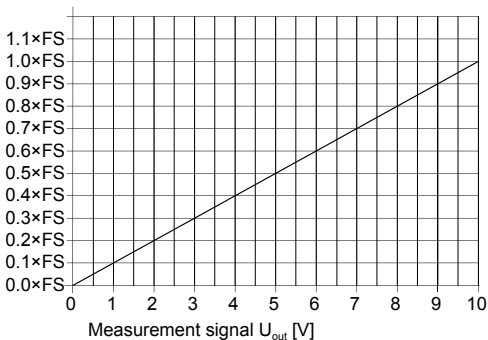

$$p = (U_{out} / 10 \text{ V}) \times p(\text{FS})$$

Conversion Torr  $\leftrightarrow$  Pascal

Torr	mbar <sup>3)</sup>	Pa <sup>3)</sup>
1:00	1013.25 / 760 = 1.3332...	101325 / 760 = 133.3224...

Example: Gauge with 10 Torr FS  
Measurement signal  $U_{out} = 6 \text{ V}$

$$\begin{aligned} p &= (6 \text{ V} / 10 \text{ V}) \times 10 \text{ Torr} \\ &= 0.6 \times 10 \text{ Torr} = \mathbf{6 \text{ Torr}} \end{aligned}$$

<sup>3)</sup> Source: NPL (National Physical Laboratory)  
Guide to the Measurement of Pressure and Vacuum, ISBN 0904457x / 1998

## 4 Installation



### WARNING

Fragile components

The ceramic sensor may be damaged by impacts.

- Do not drop the product and prevent shocks and impacts.



### DANGER

Leaking process media

High-intensity mechanical, chemical or thermal impacts can cause leaks in the measuring sensor. Process media can thus leak and possibly cause hazards, if overpressure is in the vacuum system.

- Avoid high-intensity mechanical, chemical or thermal impacts and overpressure in the vacuum system.
- Take appropriate measures (e.g. shut off gas supply, extraction, leak test) to avoid hazards or damage due to leaking process media.

### 4.1 Vacuum Connection



### DANGER

Overpressure in the vacuum system  $>1$  bar

Injury caused by released parts and harm caused by escaping process gases can result if clamps are opened while the vacuum system is pressurized.

- Do not open any clamps while the vacuum system is pressurized. Use the type of clamps which are suited to overpressure.

**DANGER**

Overpressure in the vacuum system >2.5 bar  
KF flange connections with elastomer seals (e.g. O-rings) cannot withstand such pressures. Process media can thus leak and possibly damage your health.

- Use O-rings provided with an outer centering ring.

**DANGER**

Protective ground

Products that are not correctly connected to ground can be extremely hazardous in the event of a fault. The gauge must be electrically connected to the grounded vacuum chamber. This connection must conform to the requirements of a protective connection according to EN 61010:

- CF and VCR connections fulfill this requirement.
- For gauges with a KF vacuum connection, use a conductive metallic clamping ring.
- For gauges with a 1/2" tube, take appropriate measures to fulfill this requirement.

**Caution**

Vacuum component

Dirt and damages impair the function of the vacuum component.

- When handling vacuum components, take appropriate measures to ensure cleanliness and prevent damages.

**Caution**

Dirt sensitive area

Touching the product or parts thereof with bare hands increases the desorption rate.

- Always wear clean, lint-free gloves and use clean tools when working in this area.



Mount the gauge so that no vibrations occur. The gauge may be mounted in any orientation. To keep condensates and particles from getting into the measuring chamber preferably choose a horizontal to upright position and possibly use a seal with a centering ring and filter. If adjustment should be possible after the gauge has been installed, be sure to install it so that the buttons can be accessed with a pin.

Remove the protective lid and connect the product to the vacuum system.

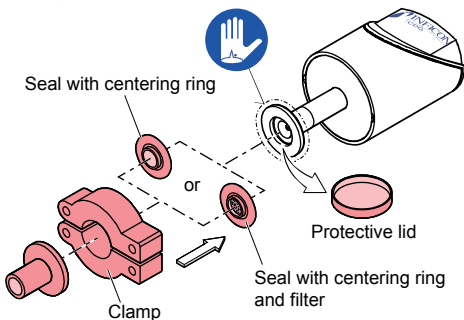

Keep the protective lid.



## 4.2 Power Connection



Make sure the vacuum connection is properly made.



### DANGER

The gauge may only be connected to power supplies, instruments or control devices that conform to the requirements of a grounded protective extra-low voltage (PELV) and limited power source (LPS), Class 2.

- The connection to the gauge has to be fused <sup>4)</sup>.



Ground loops, differences of potential, or EMC problems may affect the measurement signal. For optimum signal quality, please do observe the following notes:

- Connect the cable shield to ground on one side via the chassis ground. Do not connect the other side of the shield.
- Connect the supply common with protective ground directly at the power supply.
- Use differential measurement input (signal common and supply common conducted separately).
- Potential difference between supply common and housing  $\leq 18$  V (overvoltage protection).

If no sensor cable is available, make one according to the following diagram. Connect the sensor cable.

<sup>4)</sup> INFICON controllers fulfill these requirements.

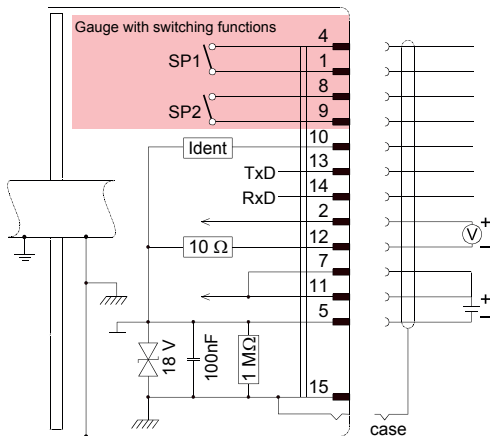

Pin 1, 4	Relay SP1, closing contact
Pin 2	Signal Output or thresholds SP1/2
Pin 5	Supply common, GND
Pin 7, 11	Supply
Pin 8, 9	Relay SP2, closing contact
Pin 10	Gauge identification Inficon
Pin 12	Signal common
Pin 13	RS232, TxD
Pin 14	RS232, RxD
Pin 15	Housing (Chassis Ground)
case	Connector case

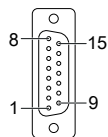

D-sub, 15-pin  
female  
soldering side

## 5 Operation

Put the gauge into operation. If you are using an INFICON controller (VGC032 or VGC40x series), define the measurement range.

### Warm-up time

<ul style="list-style-type: none"> <li>for general purpose reading (within specifications)</li> </ul>	>¼ hour
<ul style="list-style-type: none"> <li>for precision measurement and zero adjustment</li> </ul>	>2 hours

### 5.1 Displays

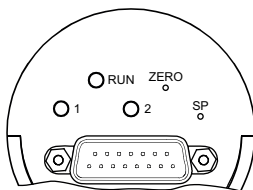

LED	State	Meaning
<RUN>	lit blinking	measurement mode other mode, warning, over-/ underrange, error
<1> (CDG025D-S only)	lit blinking	p ≤ setpoint level 1 adjusting setpoint 1
<2> (CDG025D-S only)	lit blinking	p ≤ setpoint level 2 adjusting setpoint 2

## 5.2 Zeroing the Gauge

The gauge is factory calibrated while "standing upright" (→ "Calibration Test Report").



We recommend performing a zero adjustment, when the gauge is operated for the first time.

Due to long time operation or contamination, a zero drift could occur and zero adjustment may become necessary.

For adjusting the zero, operate the gauge under the same constant ambient conditions and in the same mounting orientation as normally.

The output signal (measurement signal) is depending on the mounting orientation. The signal difference between the vertical and horizontal mounting orientation is:

FS	$\Delta U / 90^\circ$
1000 Torr/mbar	≈2 mV
100 Torr/mbar	≈10 mV
10 Torr/mbar	≈50 mV
1 Torr/mbar	≈300 mV
0.1 Torr/mbar	≈1.8 V



If the gauge is operated via a controller, the zero of the whole measuring system has to be adjusted on the controller:

- First, adjust the zero of the gauge and then, the zero of the controller.

### 5.2.1 <ZERO> Adjustment



The zero can be adjusted via

- the <ZERO> button on the gauge
- the RS232C interface
- an INFICON Vacuum Gauge Controller (VGC series)

- 1 Evacuate the gauge to a pressure according to the table below:

FS	Recommended final pressure for zero adjustment		
	[Torr]	[Pa]	[mbar]
1100 mbar	–	$<7 \times 10^0$	$<7 \times 10^{-2}$
1000 Torr	$<5 \times 10^{-2}$	$<7 \times 10^0$	–
500 Torr/mbar	$<2.5 \times 10^{-2}$	$<3 \times 10^{-0}$	$<3 \times 10^{-2}$
200 Torr/mbar	$<1 \times 10^{-2}$	$<1 \times 10^{-0}$	$<1 \times 10^{-2}$
100 Torr/mbar	$<5 \times 10^{-3}$	$<7 \times 10^{-1}$	$<7 \times 10^{-3}$
20 Torr/mbar	$<1 \times 10^{-3}$	$<1 \times 10^{-1}$	$<1 \times 10^{-3}$
10 Torr/mbar	$<5 \times 10^{-4}$	$<7 \times 10^{-2}$	$<7 \times 10^{-4}$
2 Torr/mbar	$<1 \times 10^{-4}$	$<1 \times 10^{-2}$	$<1 \times 10^{-4}$
1 Torr/mbar	$<5 \times 10^{-5}$	$<7 \times 10^{-3}$	$<7 \times 10^{-5}$
0.25 Torr/mbar	$<1 \times 10^{-5}$	$<1 \times 10^{-3}$	$<1 \times 10^{-5}$
0.1 Torr/mbar	$<5 \times 10^{-6}$	$<7 \times 10^{-4}$	$<7 \times 10^{-6}$

If the final pressure is too high for zero adjustment ( $>25\%$  of the FS), the zero cannot be reached and the <RUN> LED blinks green. If this is the case, activate the factory setting and adjust the zero again ( $\rightarrow$  27).

- 2 Operate the gauge for at least 2 hours under constant ambient conditions (until the signal is stable).
- 3 Briefly press the <ZERO> button with a pin (max.  $\varnothing 1.1$  mm). The zero adjustment runs automatically. The <RUN> LED blinks until the adjustment (duration  $\leq 8$  s) is completed.

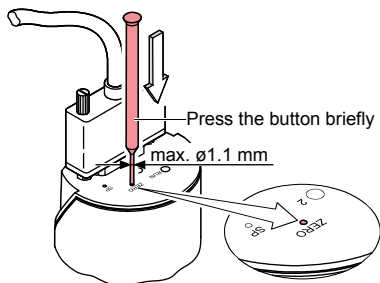

After zero adjustment the gauge automatically returns to measurement mode. The <RUN> LED lits.

The <RUN> LED blinks green if

- the signal output is negative ( $< -20$  mV) when the final pressure has been attained
- the zero adjustment has failed.

### 5.2.2 <ZERO> Adjustment with Ramp Function

The ramp function allows to adjust the zero at a known reference pressure within the measurement range of the gauge.

It also permits to adjust an offset of the characteristic curve in order to

- compensate for the offset of the measuring system or
- obtain a slightly positive zero for a 0 ... 10 V AD converter.

The offset should not exceed 2% of the FS (+200 mV). At a higher positive offset, the upper limit of the measurement range is exceeded.



Recommended procedure for adjusting the offset of a measuring system: Notice → 20.

- 1 Operate the gauge for at least 2 hours under constant ambient conditions (until the signal is stable).
- 2 Push the <ZERO> button with a pin (max.  $\varnothing 1.1$  mm) and keep it depressed. The <RUN> LED starts blinking. After 5 s, the zero adjustment value, starting at the current output value, keeps continually changing (ramp) until the button is released or until the setting limit (max. 25% FS) is reached. The corresponding output signal is delayed by about 1 s.

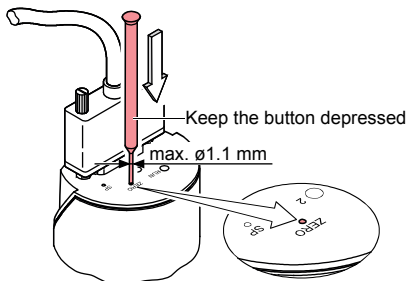

- Fine adjustment of the zero adjustment value: Release the button. Briefly press it again within 3 s. The value changes by one unit (push <ZERO> button in intervals of 1 s).
- Change of direction (inverse ramp): Release the button. Press and keep it depressed again within 3...5 s (the blinking frequency of the <RUN> indicator changes briefly).



If the <ZERO> button is released for more than 5 s, the gauge returns to the measurement mode.



The zero with Base-Pressure-Offset can also be adjusted via the RS232C interface ( $\rightarrow$  [5]).

The <RUN> LED flashes if the signal output is negative (< -20 mV).

### 5.3 Switching Functions (CDG025D-S only)

The two setpoints can be set to any pressure within the measurement range of the gauge.

The current setpoint setting

- is output at the D-sub connector instead of the measurement signal and can be measured with a voltmeter after the <SP> button is pressed
- can be read/written via the RS232C interface.

If the pressure in the vacuum system is lower than the setpoint, the corresponding LED (<1> or <2>) is lit solid and the corresponding relay is energized.

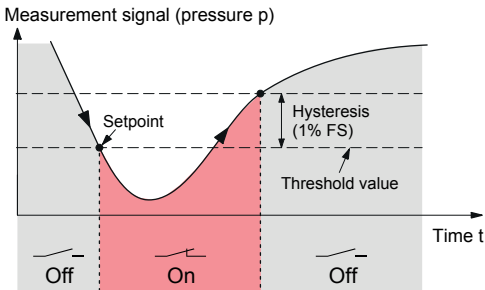

#### 5.3.1 Adjusting the Setpoints



The setpoints can be adjusted via

- the buttons on the gauge
- the RS232C interface



**DANGER****Malfunction**

If processes are controlled via the signal output, keep in mind that by pushing the <SP> button the measurement signal is suppressed and the corresponding threshold value is output instead. This can cause malfunctions.

- Push the <SP> button only if you are sure that no malfunction will cause.

**Adjusting Setpoint <1>**

- 1 Push the <SP> button with a pin (max.  $\varnothing 1.1$  mm). The gauge changes to the switching function mode and outputs the current threshold value at the measurement signal output for about 10 s (LED <1> blinks).

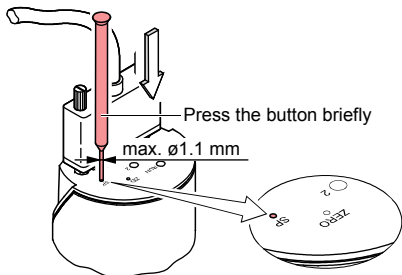

- 2 For changing the threshold value, push the <ZERO> button and keep it depressed. The threshold keeps changing from the current value (ramp) until the button is released or until the limit of the setting range is reached.

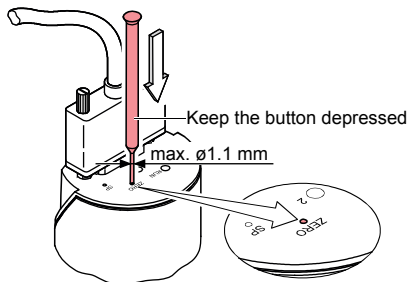

- Fine adjustment of the threshold value: Release the button. Briefly press it again within 3 s. The value changes by one unit (push <ZERO> button in intervals of 1 s).
- Change of direction (inverse ramp): Release the button. Press and keep it depressed again within 3...5 s (the blinking frequency of the <RUN> indicator changes briefly).



If the <ZERO> button is released for more than 5 s, the gauge returns to the measurement mode.



The upper threshold is automatically set 1% FS above the lower one (hysteresis).

### Adjusting Setpoint <2>

Push the <SP> button twice (the LED <2> blinks). The adjustment procedure is the same as for setpoint <1>.

## 5.4 Activating the Factory Setting (Factory Reset)

All user defined parameters (e.g. zero, filter) are restored to their default values.



Loading of the default parameters is irreversible.

Loading the default parameters:

- 1 Put the gauge out of operation.
- 2 Keep the <ZERO> button depressed for at least 5 s while the gauge is being put into operation (Power ON).

## 6 Deinstallation



### WARNING

Fragile components

The ceramic sensor may be damaged by impacts.

- Do not drop the product and prevent shocks and impacts.



### DANGER

Contaminated parts

Contaminated parts can be detrimental to health and environment.

- Before beginning to work, find out whether any parts are contaminated. Adhere to the relevant regulations and take the necessary precautions when handling contaminated parts.

**Caution**

Vacuum component

Dirt and damages impair the function of the vacuum component.

- When handling vacuum components, take appropriate measures to ensure cleanliness and prevent damages.

**Caution**

Dirt sensitive area

Touching the product or parts thereof with bare hands increases the desorption rate.

- Always wear clean, lint-free gloves and use clean tools when working in this area.

- 1 Vent the vacuum system.
- 2 Put the gauge out of operation and disconnect the sensor cable.
- 3 Remove the gauge from the vacuum system and install the protective lid.

## 7 Maintenance, Repair

Under clean operating conditions, the product requires no maintenance.



Gauge failures due to contamination are not covered by the warranty.

- We recommend checking the zero at regular intervals.

INFICON assumes no liability and the warranty becomes null and void if any repair work is carried out by the end-user or third parties.

## 8 Returning the Product



### WARNING

Forwarding contaminated products

Contaminated products (e.g. radioactive, toxic, caustic or biological hazard) can be detrimental to health and environment.

- Products returned should preferably be free of harmful substances. Adhere to the forwarding regulations of all involved countries and forwarding companies. Enclose a duly completed declaration of contamination (form under [www.inficon.com](http://www.inficon.com)).

Products that are not clearly declared as "free of harmful substances" are decontaminated at the expense of the customer.

Products not accompanied by a duly completed declaration of contamination are returned to the sender at his own expense.

## 9 Disposal



### DANGER

Contaminated parts

Contaminated parts can be detrimental to health and environment.

- Before beginning to work, find out whether any parts are contaminated. Adhere to the relevant regulations and take the necessary precautions when handling contaminated parts.

**WARNING**

Substances detrimental to the environment  
Products or parts thereof (mechanical and electric components, operating fluids etc.) can be detrimental to the environment.





- Dispose of such substances in accordance with the relevant local regulations.

**Separating the components**

After disassembling the product, separate its components according to the following criteria:

- Contaminated components  
Contaminated components (radioactive, toxic, caustic or biological hazard etc.) must be decontaminated in accordance with the relevant national regulations, separated according to their materials, and disposed of.
- Other components  
Such components must be separated according to their materials and recycled.

## Further Information

-  [1] Operating Manual  
Vacuum Gauge Controller VGC032  
tinb02e1  
INFICON AG, LI-9496 Balzers, Liechtenstein
-  [2] Operating Manual  
Single-Channel Controller VGC401  
tinb01e1  
INFICON AG, LI-9496 Balzers, Liechtenstein
-  [3] Operating Manual  
Two- & Three-Channel Measurement and Control Unit  
VGC402, VGC403  
tinb07e1  
INFICON AG, LI-9496 Balzers, Liechtenstein
-  [4] Operating Manual  
Single-, Two- & Three-Channel Measurement and Control Unit  
VGC501, VGC502, VGC503  
tina96e1  
INFICON AG, LI-9496 Balzers, Liechtenstein
-  [5] Communication Protocol  
RS232C SKY® CDG025D, SKY® CDG025D-S  
tira49e1  
INFICON AG, LI-9496 Balzers, Liechtenstein

## ETL Certification

RECOGNIZED  
COMPONENT



Intertek  
3103457

ETL LISTED

The products CDG025D & CDG025D-S

- conform to the UL Standard UL 61010-1
- are certified to the CAN/CSA Standard C22.2#61010-1-12



# CE EU Declaration of Conformity

**Manufacturer:** INFICON AG, Alte Landstraße 6, LI-9496 Balzers

This declaration of conformity is issued under the sole responsibility of the manufacturer.

**Products:** SKY® CDG025D, SKY® CDG025D-S

The products of the declaration described above are in conformity with following Union harmonization legislation:

- 2014/30/EU, OJ L 96/79, 29.3.2014  
(EMC Directive; Directive relating to electromagnetic compatibility)
- 2011/65/EU, OJ L 174/88, 1.7.2011  
(RoHS Directive; Directive on the restriction of the use of certain hazardous substances in electrical and electronic equipment)

Harmonized and international/national standards and specifications:

- EN 61010-1:2010 + A1:2019 + A1:2019/AC:2019  
(Safety requirements for electrical equipment for measurement, control and laboratory use)
- EN 61326-1:2013; Group 1, Class B  
(EMC requirements for electrical equipment for measurement, control and laboratory use)

**Signed for and on behalf of:** INFICON AG, Alte Landstraße 6, LI-9496 Balzers

Balzers, 2024-08-26



William Opie  
Managing Director

Balzers, 2024-08-26

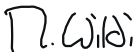

Michael Wildi  
Director Marketing

**UK  
CA** **UKCA Declaration of Conformity**

**Manufacturer:** INFICON AG, Alte Landstraße 6, LI-9496 Balzers

This declaration of conformity is issued under the sole responsibility of the manufacturer.

**Products:** SKY® CDG025D, SKY® CDG025D-S

The products of the declaration described above are in conformity with the relevant UK Statutory Instruments:

- S.I. 2016/1091, 11.2016  
(Regulation relating to electromagnetic compatibility 2016)
- S.I. 2012/3032, 12.2012  
(Regulation on the restriction of the use of certain hazardous substances in electrical and electronic equipment 2012)

Harmonized and international/national standards and specifications:

- EN 61010-1:2010 + A1:2019 + A1:2019/AC:2019  
(Safety requirements for electrical equipment for measurement, control and laboratory use)
- EN 61326-1:2013; Group 1, Class B  
(EMC requirements for electrical equipment for measurement, control and laboratory use)

**Signed for and on behalf of:** INFICON AG, Alte Landstraße 6, LI-9496 Balzers

Balzers, 2024-08-26



William Opie  
Managing Director

Balzers, 2024-08-26

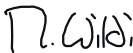

Michael Wildi  
Director Marketing

**Notes**



LI-9496 Balzers  
Liechtenstein  
Tel +423 / 388 3111  
reachus@inficon.com  
www.inficon.com

*Original: German tina49d1-f (2024-08)*



tina49e1-f