



# SQC-310™

## Deposition Controller

PN 074-550-P1E



## **Trademarks**

The trademarks of the products mentioned in this manual are held by the companies that produce them.

SQC-310™ and INFICON® are trademarks of INFICON GmbH.

Visual Basic®, Windows®, and Microsoft® are registered trademarks of Microsoft Corporation.

Java® is a registered trademark of Oracle and/or its affiliates.

Inconel® is a registered trademark of Inco Alloys International, Huntington, WV.

All other brand and product names are trademarks or registered trademarks of their respective companies.

## **Disclaimer**

The information contained in this manual is believed to be accurate and reliable. However, INFICON assumes no responsibility for its use and shall not be liable for any special, incidental, or consequential damages related to the use of this product.

Due to our continuing program of product improvements, specifications are subject to change without notice.

## **Copyright**

©2016 All rights reserved.

Reproduction or adaptation of any part of this document without permission is unlawful.



**DECLARATION  
OF  
CONFORMITY**

This is to certify that this equipment, designed and manufactured by:

**INFICON Inc.  
Two Technology Place  
East Syracuse, NY 13057  
USA**

Meets the essential safety requirements of the European Union and is placed on the market accordingly. It has been constructed in accordance with good engineering practice in safety matters in force in the Community and does not endanger the safety of persons, domestic animals or property when properly installed and maintained and used in applications for which it was made.

**Equipment Description:** SQC-310 Rate / Thickness Controller (including all options).

**Applicable Directives:** 2014/35/EU (LVD)  
2014/30/EU (General EMC)  
2011/65/EU (RoHS2)

**Applicable Standards:**

**Safety:** EN 61010-1: 2010 Safety Requirements for Electrical Equipment For Measurement, Control, And Laboratory Use.  
PART 1: General Requirements

**Emissions:** EN 61326-1: 2013 (Radiated & Conducted Emissions)  
(EMC – Measurement, Control & Laboratory Equipment)  
CISPR 11/EN 55011 Edition 2009-12 Emission standard for industrial, scientific, and medical (ISM) radio RF equipment  
FCC Part 18 Class A emissions requirement (USA)

**Immunity:** EN 61326-1: 2013 (Industrial EMC Environments)  
(EMC – Measurement, Control & Laboratory Equipment)

**RoHS2:** Fully Compliant

**CE Implementation Date:** May 2001 (Revised August, 2015)

**Authorized Representative:** Steven Schill  
  
Thin Film Business Line Manager  
INFICON, Inc.

# Warranty

---

**WARRANTY AND LIABILITY - LIMITATION:** Seller warrants the products manufactured by it, or by an affiliated company and sold by it, and described on the reverse hereof, to be, for the period of warranty coverage specified below, free from defects of materials or workmanship under normal proper use and service. The period of warranty coverage is specified for the respective products in the respective Seller instruction manuals for those products but shall not be less than two (2) years from the date of shipment thereof by Seller. Seller's liability under this warranty is limited to such of the above products or parts thereof as are returned, transportation prepaid, to Seller's plant, not later than thirty (30) days after the expiration of the period of warranty coverage in respect thereof and are found by Seller's examination to have failed to function properly because of defective workmanship or materials and not because of improper installation or misuse and is limited to, at Seller's election, either (a) repairing and returning the product or part thereof, or (b) furnishing a replacement product or part thereof, transportation prepaid by Seller in either case. In the event Buyer discovers or learns that a product does not conform to warranty, Buyer shall immediately notify Seller in writing of such non-conformity, specifying in reasonable detail the nature of such non-conformity. If Seller is not provided with such written notification, Seller shall not be liable for any further damages which could have been avoided if Seller had been provided with immediate written notification.

THIS WARRANTY IS MADE AND ACCEPTED IN LIEU OF ALL OTHER WARRANTIES, EXPRESS OR IMPLIED, WHETHER OF MERCHANTABILITY OR OF FITNESS FOR A PARTICULAR PURPOSE OR OTHERWISE, AS BUYER'S EXCLUSIVE REMEDY FOR ANY DEFECTS IN THE PRODUCTS TO BE SOLD HEREUNDER. All other obligations and liabilities of Seller, whether in contract or tort (including negligence) or otherwise, are expressly EXCLUDED. In no event shall Seller be liable for any costs, expenses or damages, whether direct or indirect, special, incidental, consequential, or other, on any claim of any defective product, in excess of the price paid by Buyer for the product plus return transportation charges prepaid.

No warranty is made by Seller of any Seller product which has been installed, used or operated contrary to Seller's written instruction manual or which has been subjected to misuse, negligence or accident or has been repaired or altered by anyone other than Seller or which has been used in a manner or for a purpose for which the Seller product was not designed nor against any defects due to plans or instructions supplied to Seller by or for Buyer.

This manual is intended for private use by INFICON<sup>®</sup> Inc. and its customers. Contact INFICON before reproducing its contents.

NOTE: These instructions do not provide for every contingency that may arise in connection with the installation, operation or maintenance of this equipment. Should you require further assistance, please contact INFICON.



# Table Of Contents

Cover Page	
Trademarks	
Disclaimer	
Copyright	
Declaration Of Conformity	

## Chapter 1

### Introduction

1.1	Introduction . . . . .	1-1
1.1.1	Related Operating Manuals . . . . .	1-2
1.2	SQC-310 Safety . . . . .	1-2
1.2.1	Definition of Notes, Cautions and Warnings. . . . .	1-2
1.2.2	General Safety Information. . . . .	1-3
1.2.3	Earth Ground . . . . .	1-3
1.3	How to Contact INFICON . . . . .	1-5
1.3.1	Returning SQC-310 to INFICON . . . . .	1-5
1.4	SQC-310 Specifications . . . . .	1-6
1.4.1	Measurement . . . . .	1-6
1.4.2	Sensor . . . . .	1-6
1.4.3	Source . . . . .	1-6
1.4.4	Digital I/O . . . . .	1-6
1.4.5	Power . . . . .	1-7
1.4.6	Operating Environment. . . . .	1-7
1.4.7	Dimensions & Weight . . . . .	1-7
1.4.8	Cleaning . . . . .	1-7
1.4.9	Display . . . . .	1-8
1.4.10	Process Parameters . . . . .	1-8
1.4.11	Layer Parameters . . . . .	1-8
1.4.12	Film Parameters . . . . .	1-9
1.5	Unpacking and Inspection . . . . .	1-10
1.6	Configurations and Accessories . . . . .	1-10
1.6.1	SQC-310 Configuration . . . . .	1-10
1.6.2	Accessories . . . . .	1-11
1.6.2.1	Cables and Oscillator Kits . . . . .	1-11
1.6.2.2	Handheld Remote Controller . . . . .	1-12
1.6.2.3	Rack Mount Kits . . . . .	1-12

1.6.2.4	Crystal Sensors . . . . .	1-12
1.7	Initial Power-On Verification . . . . .	1-13

## Chapter 2

### Installation

2.1	Introduction . . . . .	2-1
2.2	Front Panel . . . . .	2-3
2.3	Rear Panel . . . . .	2-4
2.4	System Connections . . . . .	2-5
2.5	Ground Requirements . . . . .	2-6
2.5.1	Establishing Earth Ground . . . . .	2-7
2.6	Handheld Remote Controller . . . . .	2-7
2.7	Rack Mount . . . . .	2-8
2.7.1	Full Rack Extender . . . . .	2-8
2.7.1.1	Inventory . . . . .	2-8
2.7.1.2	Installation . . . . .	2-9
2.7.2	Rack Adapter . . . . .	2-10
2.7.2.1	Inventory . . . . .	2-10
2.7.2.2	Installation . . . . .	2-11
2.8	I/O Connections . . . . .	2-11
2.9	Interfacing SQC-310 to CI-100 Crucible Indexer . . . . .	2-12
2.9.1	BCD I/O Setup . . . . .	2-12
2.9.2	Individual (Binary - as defined by CI-100) I/O Setup . . . . .	2-14
2.10	Interfacing SQC-310 to INFICON EBS-530 Electron Beam Sweep Controller . . . . .	2-15

## Chapter 3

### Operation

3.1	Thin Film Deposition Overview . . . . .	3-1
3.1.1	Definitions . . . . .	3-1
3.1.2	Thin Film Deposition Phases . . . . .	3-2
3.2	SQC-310 Menu Overview . . . . .	3-3
3.3	Main Screen, Menu 1 . . . . .	3-5
3.4	Main Screen, Menu 2 . . . . .	3-6
3.5	Main Screen, Menu 3 . . . . .	3-7
3.6	Quick Edit Menu . . . . .	3-8
3.7	Process Menus . . . . .	3-10
3.8	Process Menu - Edit Layer . . . . .	3-12
3.9	Layer Copy, Insert, and Delete Menus . . . . .	3-15
3.10	Film Menus . . . . .	3-17

3.11	Film Edit Menu . . . . .	3-18
3.11.1	Film Conditioning Menu . . . . .	3-21
3.11.2	Film Deposit Controls Menu . . . . .	3-22
3.11.3	Film Configure Sensor Menu . . . . .	3-24
3.12	System Menu . . . . .	3-25
3.12.1	Input and Relay Menus. . . . .	3-27
3.12.2	Logic Menu . . . . .	3-30
3.12.2.1	Creating a Logic Statement . . . . .	3-31
3.12.2.2	Logic Statement Conditions (IF). . . . .	3-32
3.12.2.3	Logic Statement Actions (THEN) . . . . .	3-35
3.12.3	Sensors and Sources Menu . . . . .	3-36
3.12.3.1	Sensor Setup . . . . .	3-36
3.12.3.2	Source Setup . . . . .	3-39

## Chapter 4

### Communications

4.1	Introduction. . . . .	4-1
4.1.1	RS-232 Serial Port . . . . .	4-1
4.1.2	USB Port. . . . .	4-2
4.1.3	Ethernet (TCP/IP) Port . . . . .	4-2
4.1.3.1	Ethernet Network Protocol . . . . .	4-2
4.1.3.1.1	Accessing Network Settings in Windows XP . . . . .	4-3
4.1.3.1.2	Accessing Network Settings in Windows 7 and Windows 8. . . . .	4-5
4.1.3.2	How to change the SQC-310 IP address . . . . .	4-7
4.2	SQC-310 Communications Protocol. . . . .	4-8
4.2.1	Command Packet (Host to SQC-310 Message). . . . .	4-9
4.2.2	Response Packet (SQC-310 to Host Message). . . . .	4-10
4.2.3	Calculating the CRC . . . . .	4-11
4.3	SQC-310 Commands . . . . .	4-12
4.3.1	@ Command: Hello Message. . . . .	4-12
4.3.1.1	Hello Message Example. . . . .	4-12
4.3.2	A Commands: Get/Set Film Parameters . . . . .	4-12
4.3.2.1	Get/Set Film Parameter Examples. . . . .	4-14
4.3.3	B Commands: Get/Set System Parameters. . . . .	4-14
4.3.3.1	Get/Set System Parameter Examples . . . . .	4-15
4.3.4	C Commands: Get/Set Process Parameters . . . . .	4-16
4.3.4.1	Get/Set Process Parameter Examples. . . . .	4-17
4.3.5	D Commands and E Command: Get/Set Layer Parameters . . . . .	4-17
4.3.5.1	Get/Set Layer Parameter Examples. . . . .	4-19

4.3.6	F Command: Get/Set Material Parameters . . . . .	4-20
4.3.6.1	Get/Set Material Parameter Examples. . . . .	4-20
4.3.7	G Commands: Get/Set Input and Relay Parameters . . . . .	4-21
4.3.7.1	Get/Set Input and Relay Parameter Examples . . . . .	4-22
4.3.8	H Commands: Get/Set Sensor and Source Parameters . . . . .	4-23
4.3.8.1	Get/Set Sensor and Source Parameter Examples. . . . .	4-24
4.3.9	I Commands: Get/Set Logic Statement Parameters . . . . .	4-25
4.3.9.1	Get/Set Logic Statement Parameter Examples . . . . .	4-25
4.3.10	J Command: Get Num Channels . . . . .	4-26
4.3.10.1	Get Num Channels Examples . . . . .	4-26
4.3.11	K Command: Get Readings . . . . .	4-26
4.3.11.1	Get Readings Examples. . . . .	4-27
4.3.12	L Command: Get Sensor Rate . . . . .	4-27
4.3.12.1	Get Sensor Rate Example . . . . .	4-27
4.3.13	M Command: Get Output Rate. . . . .	4-27
4.3.13.1	Get Output Rate Example . . . . .	4-28
4.3.14	N Command: Get Sensor Thickness . . . . .	4-28
4.3.14.1	Get Sensor Thickness Example . . . . .	4-28
4.3.15	O Command: Get Output Thickness . . . . .	4-28
4.3.15.1	Get Output Thickness Example . . . . .	4-28
4.3.16	P Commands: Get Sensor Frequency/Crystal Life . . . . .	4-29
4.3.16.1	Get Sensor Frequency/Crystal Life Example . . . . .	4-29
4.3.17	Q Command: Get Output Deviation . . . . .	4-29
4.3.17.1	Get Output Deviation Example. . . . .	4-29
4.3.18	S Command: Get/Set Output Power . . . . .	4-30
4.3.18.1	Get/Set Output Power Examples . . . . .	4-30
4.3.19	T Command: Set Active Process . . . . .	4-31
4.3.19.1	Set Active Process Example . . . . .	4-31
4.3.20	U Commands: Set Run State . . . . .	4-31
4.3.20.1	Set Run State Example . . . . .	4-31
4.3.21	V Commands: Get Run State. . . . .	4-32
4.3.21.1	Get Run State Examples . . . . .	4-33
4.3.22	XSTART / XSTOP Command: Download/Upload Session . . . . .	4-34
4.3.22.1	Start/Stop Download/Upload Session Example . . . . .	4-34
4.4	CRC Examples. . . . .	4-34
4.4.1	Visual Basic® 5/6 . . . . .	4-35
4.4.2	Java® . . . . .	4-37
4.4.3	C++. . . . .	4-38



## Chapter 5

### SQC-310 Comm Software

5.1	Introduction . . . . .	5-1
5.2	Installation . . . . .	5-1
5.3	Main Window . . . . .	5-2
5.4	Data Log Menu . . . . .	5-4
5.5	Instrument Window . . . . .	5-6
5.5.1	Process Tree . . . . .	5-8
5.5.2	Film Menu . . . . .	5-9
5.5.3	Materials Menu . . . . .	5-10
5.5.4	Sensor Setup Menu . . . . .	5-11
5.5.5	Source Setup Menu . . . . .	5-12
5.5.6	Digital I/O Setup Menu . . . . .	5-13
5.5.7	Logic Statements Menu . . . . .	5-16
5.5.7.1	Creating Logic Statements . . . . .	5-18
5.5.8	System Setup Menu . . . . .	5-18
5.6	Graph Menu . . . . .	5-19
5.7	Communications Setup Menu . . . . .	5-20
5.8	View Menu . . . . .	5-22
5.9	Help Menu . . . . .	5-23

## Chapter 6

### Troubleshooting and Maintenance

6.1	Troubleshooting . . . . .	6-1
6.1.1	Using the OSC-100A Oscillator Test Function . . . . .	6-14
6.2	Cleaning . . . . .	6-15
6.3	Upgrading Firmware . . . . .	6-15
6.4	Clearing the Memory . . . . .	6-15
6.5	Spare Parts . . . . .	6-17

## Chapter 7

### Calibration Procedures

7.1	Importance of Density, Tooling and Z-Ratio . . . . .	7-1
7.2	Determining Density . . . . .	7-1
7.3	Determining Tooling . . . . .	7-2
7.4	Laboratory Determination of Z-Ratio . . . . .	7-3
7.5	Control Loop . . . . .	7-5
7.5.1	Identifying a Fast or Slow Source . . . . .	7-7
7.6	Control Loop Tuning Procedure . . . . .	7-8

**Chapter 8****Measurement Theory**

8.1	Basics . . . . .	8-1
8.1.1	Monitor Crystals . . . . .	8-2
8.1.2	Period Measurement Technique . . . . .	8-4
8.1.3	Z-Match Technique . . . . .	8-5

**Appendix A****Material Table**

A.1	Introduction . . . . .	A-1
-----	------------------------	-----

# Chapter 1

## Introduction

### 1.1 Introduction

INFICON SQC-310 and SQC-310C are quartz crystal microbalance technology based deposition controllers, providing a unique combination of accuracy and powerful features in a compact, low-cost controller.

Figure 1-1 SQC-310



The standard SQC-310 is a sequential layer thin film deposition controller that can monitor two quartz crystal sensors and control one of two evaporation sources at a time. Eight process control relays and eight digital inputs are included to support a broad range of external devices. The number of sensors, outputs, and digital I/O can be doubled with an optional expansion card. SQC-310C is a thin film controller that is capable of codeposition by monitoring four quartz crystal sensors and controlling four sources simultaneously. Sixteen process control relays and sixteen digital inputs are included. Both controllers come standard with RS-232 and USB communications with an option to replace USB with Ethernet communications.

**NOTE:** SQC-310 and SQC-310C are both referred to as SQC-310 in this manual. If there is a reason to distinguish between the two models, the SQC-310 or SQC-310C model number will be called out.

Please review the entire manual for detailed operational, programming, and safety information.

**1.1.1 Related Operating Manuals**

- PN 074-154 . . . . . UHV Bakeable Sensor
- PN 074-155 . . . . . CrystalSix Sensor
- PN 074-398 . . . . . Crystal 12 Sensor
- PN 074-156 . . . . . Front Load Single and Dual Sensors
- PN 074-157 . . . . . Sputtering Crystal Sensor
- PN 074-609 . . . . . Cool Drawer Single and Dual Sensors
- PN 074-643 . . . . . ALD Sensor
- PN 153800 . . . . . RSH-600 Sensor

Sensor operating manuals are available on the Thin Film Instruments and Sensors Manuals CD included with the SQC-310 ship kit. Other related documentation can be downloaded from [www.inficon.com](http://www.inficon.com).

**1.2 SQC-310 Safety**

**1.2.1 Definition of Notes, Cautions and Warnings**

When using this manual, please pay attention to the NOTES, HINTS, CAUTIONS, and WARNINGS found throughout. For the purposes of this manual they are defined as follows:

**NOTE:** Pertinent information that is useful in achieving maximum SQC-310 efficiency when followed.

**HINT:** Hints provide insight into SQC-310 usage.



**CAUTION**

**Failure to heed these messages could result in damage to SQC-310 or loss of data.**



**WARNING**

**Failure to heed these messages could result in personal injury.**



**WARNING - Risk Of Electric Shock**

**Dangerous voltages are present which could result in personal injury.**

## 1.2.2 General Safety Information



### **WARNING - Risk Of Electric Shock**

---

SQC-310 does not have any user-serviceable components.

---



### **WARNING - Risk Of Electric Shock**

---

Dangerous voltages may be present whenever SQC-310 is turned on or external connections are present.

---



### **WARNING - Risk Of Electric Shock**

---

SQC-310 must be connected to earth ground through a sealed three-conductor power cable plugged into a socket outlet with protective ground terminal.

Extension cables must have three conductors including a protective earth ground.

---



### **WARNING**

---

Failure to operate SQC-310 in the manner intended by INFICON can circumvent the safety protection provided by SQC-310 and may result in personal injury.

---



### **CAUTION - Static Sensitive Device**

---

SQC-310 contains delicate circuitry, susceptible to transient power line voltages or static.

---

## 1.2.3 Earth Ground

SQC-310 is connected to earth ground through a sealed three-core (three-conductor) power cable, which must be plugged into a socket outlet with a protective earth terminal. Extension cables must always have three conductors including a protective earth terminal.

**WARNING**

---

**Never interrupt the protective earth circuit.**

**This symbol indicates where the protective earth ground is connected inside SQC-310.**



**Never unscrew or loosen this connection.**

**Disconnecting the protective earth terminal or interrupting the protective earth circuit, whether inside or outside of SQC-310, may render SQC-310 dangerous.**

---

## 1.3 How to Contact INFICON

Worldwide customer support information is available under **Support >> Support Worldwide** at [www.inficon.com](http://www.inficon.com):

- ◆ Sales and Customer Service
- ◆ Technical Support
- ◆ Repair Service

If experiencing a problem with SQC-310, please have the following information readily available:

- ◆ The Sales Order or PO number for the SQC-310 purchase.
- ◆ The software version, if the issue is regarding the SQC-310 Comm software.
- ◆ The firmware version of the SQC-310.
- ◆ A description of the problem.
- ◆ An explanation of any corrective action already attempted.
- ◆ The exact wording of any error messages received.

### 1.3.1 Returning SQC-310 to INFICON

Do not return any component of SQC-310 to INFICON without first speaking with a Customer Support Representative and obtaining a Return Material Authorization (RMA) number.

Packages delivered to INFICON without an RMA number will be held until the customer is contacted. This will result in delays in servicing SQC-310.

If returning a SQC-310 with a crystal sensor, or other component potentially exposed to process materials, prior to being given an RMA number a completed Declaration Of Contamination (DOC) form will be required. DOC forms must be approved by INFICON before an RMA number is issued. INFICON may require that the component be sent to a designated decontamination facility, not to the factory.

## 1.4 SQC-310 Specifications

### 1.4.1 Measurement

Crystal Frequency Range . . . . .	6.5 to 1.0 MHz (adjustable)
Frequency Resolution . . . . .	$\pm 0.012$ Hz over 0.25 s measurement interval
Frequency Accuracy . . . . .	0.001%
Measurement Rate . . . . .	0.10 to 1.0 s (adjustable)
Thickness and Rate Resolution . . . . .	$\pm 0.015$ Å @ tooling/density/z-ratio = 100/1/1, fundamental frequency = 6 MHz, 0.25 s measurement interval
Thickness Accuracy . . . . .	0.5% typical
Rate Accuracy . . . . .	0.5% typical

### 1.4.2 Sensor

Sensor Inputs . . . . .	2 (+2 optional), 4 (SQC-310C)
Measurement Technique . . . . .	Conventional (Active) Oscillation
Sensor Type . . . . .	Single, Dual, Rotary

### 1.4.3 Source

Number of Sources . . . . .	2 (+2 optional), 4 (SQC-310C)
Control Voltage . . . . .	0 to $\pm 10$ V into 2 k $\Omega$ load
Resolution . . . . .	15 bits over 10 V full scale span

### 1.4.4 Digital I/O

Digital Inputs . . . . .	8 (+8 optional), 16 (SQC-310C)
Functions . . . . .	User-selected (see <a href="#">Chapter 3, Operation</a> )
Input Rating . . . . .	5 V (dc), non-isolated, programmable active low (0 volts) or active high (5 volts).
Relay Outputs . . . . .	8 (+8 optional), 16 (SQC-310C)
Functions . . . . .	User-selected (see <a href="#">Chapter 3, Operation</a> )
Relay Rating . . . . .	30 V (rms) or 30 V (dc), 2 A maximum



### 1.4.5 Power

Mains Power Supply . . . . .	100 to 120/200 to 240V (ac), ±10% nominal, 50/60 Hz, auto detect
Power Consumption . . . . .	20 W
Fuse . . . . .	250 V, 500 mA, Type T, 5 x 20 mm, time lag
Installation (Overvoltage) . . . . .	Class 1 Equipment (grounded type). Category II for Transient Overvoltages per IEC 60664
Temporary Overvoltages . . . . .	Short Term: 1440 V, <5 s Long Term: 490 V, >5 s

### 1.4.6 Operating Environment

Usage . . . . .	Indoor Only
Operating Temperature . . . . .	0 to 50°C (32 to 122°F)
Humidity . . . . .	0 to 80% RH non-condensing. Ordinary protection (not protected against harmful ingress of moisture).
Altitude . . . . .	0 to 2000 m (6562 ft.)
Pollution Degree . . . . .	2 per EN 61010
Storage Temperature . . . . .	-10 to 70°C (14 to 158°F)
Warm Up Period . . . . .	None required. For maximum stability allow 5 minutes.

### 1.4.7 Dimensions & Weight

Rack Dimensions H x W x D . . . . .	13.28 x 21.34 x 25.40 cm (5.23 x 8.4 x 10.0 in.)
Front Clearance . . . . .	2.5 cm (1.0 in.) minimum
Rear Clearance . . . . .	10 cm (4.0 in.) minimum
Weight . . . . .	1.8 kg (4 lb.)

### 1.4.8 Cleaning

Mild, nonabrasive cleaner or detergent. Prevent cleaner from entering SQC-310 or contacting connectors.

**1.4.9 Display**

Type . . . . .	LCD/Color/TFT/14.5 cm (5.7 in.) Diagonal
Format . . . . .	QVGA
Resolution . . . . .	320 x 240 pixels
Backlighting . . . . .	LED
Thickness Display Resolution . . . . .	0.001 kÅ
Rate Display Resolution . . . . .	0.01 or 0.1 Å/s
Power Display Resolution . . . . .	0.1%
Data Display Rate . . . . .	1 Hz
Graphic Display Functions . . . . .	Rate, Deviation, Power
Readouts . . . . .	Thickness, Rate, Power

**1.4.10 Process Parameters**

**NOTE:** A Process is a sequence of layers.

# Processes . . . . .	100
# Films . . . . .	50
# Layers (total all processes) . . . . .	1000

**1.4.11 Layer Parameters**

**NOTE:** Layers are the basic building blocks of a process.

Initial Rate . . . . .	0.0 to 999.9 Å/s
Final Thickness . . . . .	0.0 to 999.990 kÅ
Time Setpoint . . . . .	0 to 5999 s
Thickness Limit . . . . .	0.0 to 999.99 kÅ
Start Mode . . . . .	Auto/Manual
Output Select . . . . .	Src1/Src2/Src3/Src4
Max Power . . . . .	0.0 to 99.9%
Min Power . . . . .	0.0 to 99.9%
Slew Rate . . . . .	0.0 to 99.9%/s
Sensor Select (1 to 4) . . . . .	On/Off
Rate Dev. Attention . . . . .	0.0 to 99.9%
Rate Dev. Alert . . . . .	0.0 to 99.9%

PN 074-550-P1E

Rate Dev. Alarm . . . . .	0.0 to 99.9%
Rate Ramp Start . . . . .	0.000 to 999.990 kÅ
Rate Ramp Time . . . . .	0 to 5999 s
New Rate . . . . .	0.0 to 999.9 Å/s

**1.4.12 Film Parameters**

**NOTE:** A film describes in detail how a material will be deposited.

Material . . . . .	100 stored
Density . . . . .	0.50 to 99.99 g/cm <sup>3</sup>
Z-Factor . . . . .	0.100 to 9.999
P Term . . . . .	1 to 9999
I Term . . . . .	0.0 to 99.9 s
D Term . . . . .	0.0 to 99.9 s
Tooling . . . . .	10 to 399%
Pocket . . . . .	1 to 8
XTAL Quality, Rate Dev . . . . .	Disabled, 1 to 99%
XTAL Quality, Counts . . . . .	Disabled, 1 to 99%
XTAL Stability, Single . . . . .	Disabled, 25 to 9999 Hz
XTAL Stability, Total . . . . .	Disabled, 25 to 9999 Hz
Crystal Fail Mode . . . . .	Halt/Halt Last/Timed Power/Next Crystal/ Switch to Backup/Backup
Ramp 1/ Ramp 2/ Feed/ Idle Power . . . . .	0 to 99.9%
Ramp 1/ Soak 1/ Ramp 2/ Soak 2/ Feed Ramp/ Feed/ Idle Ramp Time . . . . .	0 to 5999 s
Shutter Delay Time . . . . .	0 to 5999 s
Capture . . . . .	0.0 to 100%
Control Error . . . . .	Ignore/Stop/Hold
Error% . . . . .	0 to 100%
Rate Sampling . . . . .	Continuous/Time/Accuracy
Sample Time . . . . .	0 to 5999 s
Hold Time . . . . .	0 to 5999 s
Accuracy . . . . .	100%

PN 074-550-P1E

## 1.5 Unpacking and Inspection

- 1 If SQC-310 has not been removed from its packaging, do so now.
  - NOTE:** Do not discard the packing materials until an inventory has been taken and the installation has been performed successfully. To install SQC-310 see [Chapter 2, Installation](#) for details.
- 2 Take an inventory of your order by referring to the order invoice and the information contained in [section 1.6](#).
- 3 Carefully examine the contents for damage that may have occurred during shipping. This is especially important if obvious rough handling is noticed on the outside of the container. Immediately report any damage to the carrier and to INFICON. To report damage or receive technical assistance, refer to [section 1.3, How to Contact INFICON](#), on page 1-5.

## 1.6 Configurations and Accessories

### 1.6.1 SQC-310 Configuration

Figure 1-2 SQC-310 and SQC-310C configuration guide

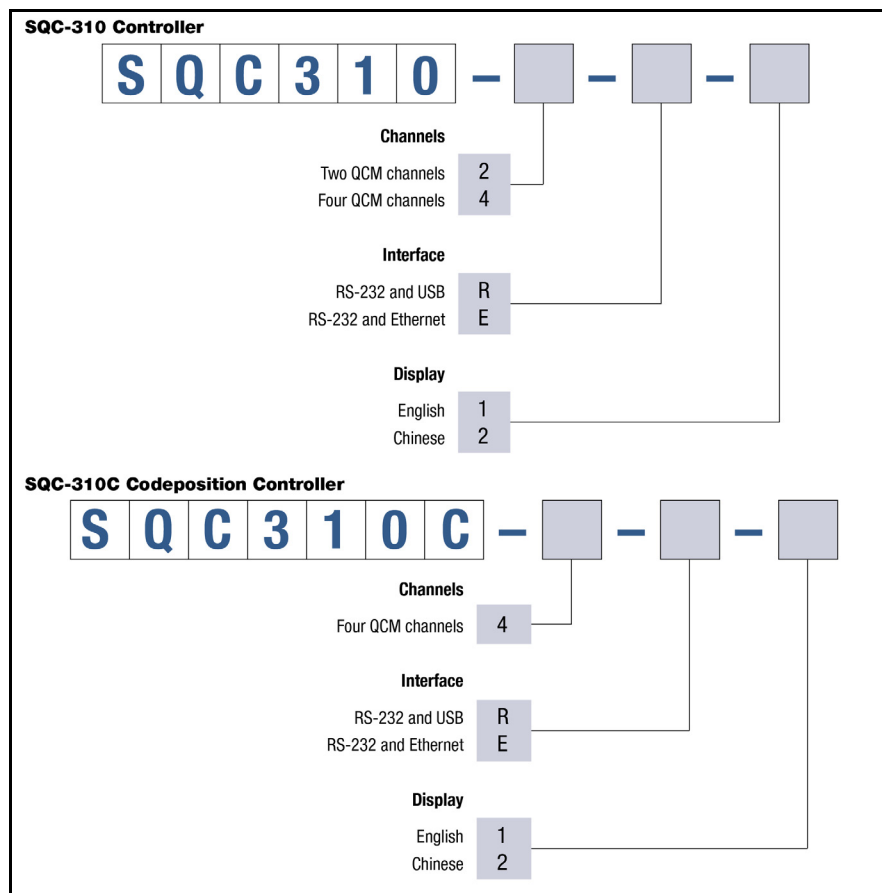

SQC-310 configuration includes:

- ◆ Thin Film Instrument and Sensor Manuals CD containing SQC-310 software, SQC-310 Operating Manual, and sensor operating manuals.
- ◆ 25-pin female high-density solder cup D-sub connector (PN 051-1846) and connector housing (PN 051-1794). One of each included for a 2 channel standard configuration. Two of each included if 4 channel option is selected or the unit is a SQC-310C.
- ◆ Power Cord - Based on origin of order (universal power supply)
  - ◆ Power Cord North American (PN 068-0433)
  - ◆ Power Cord European (PN 068-0434)
  - ◆ Power Cord UK (PN 803301)
- ◆ RS-232 Cable (PN 068-0464)
- ◆ USB Cable (PN 068-0472), if USB option is chosen
- ◆ Ethernet Cable (PN 068-0478), if Ethernet option is chosen

## 1.6.2 Accessories

### 1.6.2.1 Cables and Oscillator Kits

Oscillator Kit (3.0 m (10 ft.) cable) . . . . . PN 783-500-109-10

Oscillator Kit (7.6 m (25 ft.) cable) . . . . . PN 783-500-109-25

Oscillator Kit (15.2 m (50 ft.) cable) . . . . . PN 783-500-109-50

Oscillator Kit (22.8 m (75 ft.) cable) . . . . . PN 783-500-109-75

**NOTE:** One oscillator kit is required for each crystal sensor that will be connected to the SQC-310. Each oscillator kit includes:

- ◆ 15.2 cm (6 in.) BNC cable (PN 782-902-011) - Cable from the oscillator to the feedthrough
- ◆ OSC-100A Oscillator (PN 783-500-013)
- ◆ BNC Interconnect Cable (PN 782-902-012-XX) - Cable from the oscillator to SQC-310.



### **CAUTION**

**The electrical distance from the oscillator to the crystal must not exceed 102 cm (40 in.)**

**1.6.2.2 Handheld Remote Controller**

Handheld Remote Controller, 3 m (10 ft.) cable . . . . PN 782-900-017

**1.6.2.3 Rack Mount Kits**

3U Rack Extender - mounts one  
 SQC-310 controller in a  
 48.3 cm (19 in.) rack . . . . . PN 782-900-007

3U Rack Adapter- mounts two  
 SQC-310 controllers in a  
 48.3 cm (19 in.) rack . . . . . PN 782-900-016

**1.6.2.4 Crystal Sensors**

**NOTE:** X represents feature selections particular to that sensor. For help identifying a sensor, contact INFICON. (Refer to [section 1.3, How to Contact INFICON, on page 1-5.](#))

- Front Load Single Sensor . . . . . PN SL-XXXXX
- Front Load Dual Sensor . . . . . PN DL-AXXX
- UHV Bakeable Sensor . . . . . PN BK-AXF
- Cool Drawer Single Sensor . . . . . PN CDS-XXFXX
- Cool Drawer Dual Sensor . . . . . PN CDD-XFXX
- Sputtering Sensor . . . . . PN 750-618-G1
- ALD Sensor . . . . . PN 750-71X-GX
- CrystalSix . . . . . PN 750-446-G1
- RSH-600 . . . . . PN 15320X-XX
- Crystal 12 . . . . . PN XL12-1XXXXX

**NOTE:** Shuttered sensors, CrystalSix, and Crystal 12 require a solenoid valve (PN 750-420-G1).

**NOTE:** CrystalSix and Crystal12 crystal position detection feature cannot be used with the SQC-310.

**NOTE:** CrystalTwo switch is not compatible with SQC-310.

PN 074-550-P1E

## 1.7 Initial Power-On Verification

A preliminary functional check of SQC-310 can be made before formal installation. It is not necessary to have sensors, source controls, inputs, or relays connected to do this. For more complete installation information, see [Chapter 2, Installation](#).

- 1 Confirm that the proper AC line mains voltage is supplied to SQC-310.
- 2 Confirm that the rear panel (main) AC switch is in the ON Position.
- 3 After the initial boot-up screen, SQC-310 will display the main menu and the power graph. This screen will be similar to the screen displayed in [Figure 1-3](#).

Figure 1-3 Main screen



---

## Chapter 2

# Installation

---

### 2.1 Introduction

This chapter provides information for the necessary connections and user interfaces for SQC-310. (See [Table 2-1](#) for connection and installation requirements.)



---

#### CAUTION

Care should be exercised to route SQC-310 cables as far as is practical from other cables that carry high voltages or generate noise. This includes other line voltage cables, wires to heaters that are SCR-controlled, and cables to source power supplies that may conduct high transient currents during arc down conditions.

---



---

#### CAUTION

To maintain proper SQC-310 performance, use only the 15.2 cm (6 in.) BNC cable, included in the oscillator kit, to connect the oscillator to the crystal sensor. The in-vacuum cable or electrical conduit tube should not exceed 78.1 cm (30.75 in.).

---



Table 2-1 Installation requirements

<p><b>Rack Installation</b></p>	<p>Rack mounting hardware is not included. Optional 3U rack adapter and 3U rack extender kits are available to mount either one or two SQC-310 controllers in a standard 48.3 cm (19 in.) rack (see <a href="#">section 2.7 on page 2-8</a>).</p>
<p><b>Power Connection</b></p>	<p>The SQC-310 automatically detects mains voltages of 100 to 120 and 200 to 240 V (ac), 50/60Hz.</p> <p> <b>WARNING - Risk Of Electric Shock</b></p> <hr/> <p><b>Verify that the power cable provided is connected to a properly grounded mains receptacle.</b></p> <hr/>
<p><b>Sensor Input Connections</b></p>	<p>Connect the BNC cables and oscillators from the vacuum chamber feedthrough to the desired SQC-310 sensor inputs (see <a href="#">section 2.4 on page 2-5</a>).</p>
<p><b>Source Output Connections</b></p>	<p>Connect user-supplied BNC cables from the SQC-310 output connectors to the source power supply control input. Refer to the source power supply operating manual for control input wiring instructions.</p>
<p><b>Digital I/O Connections</b></p>	<p>See <a href="#">section 2.8, I/O Connections, on page 2-11</a> for details on wiring digital I/O to the SQC-310 I/O connectors.</p>
<p><b>Computer Connection</b></p>	<p>To collect data or program SQC-310 remotely, attach a straight-through RS-232 cable from the RS-232 connector to a computer serial port.</p> <p>SQC-310 can also communicate via USB using a standard USB cable. If the Ethernet option is chosen, the USB connection is replaced with an RJ-45 Ethernet connector (see <a href="#">Chapter 4, Communications</a> for details).</p>
<p><b>Ground Connection</b></p>	<p>Connect a grounded wire or strap to the ground terminal on the SQC-310 rear panel (see <a href="#">section 2.3, Rear Panel, on page 2-4</a> and <a href="#">section 2.5, Ground Requirements, on page 2-6</a>).</p>

PN 074-550-P1E

## 2.2 Front Panel

Figure 2-1 Front panel controls

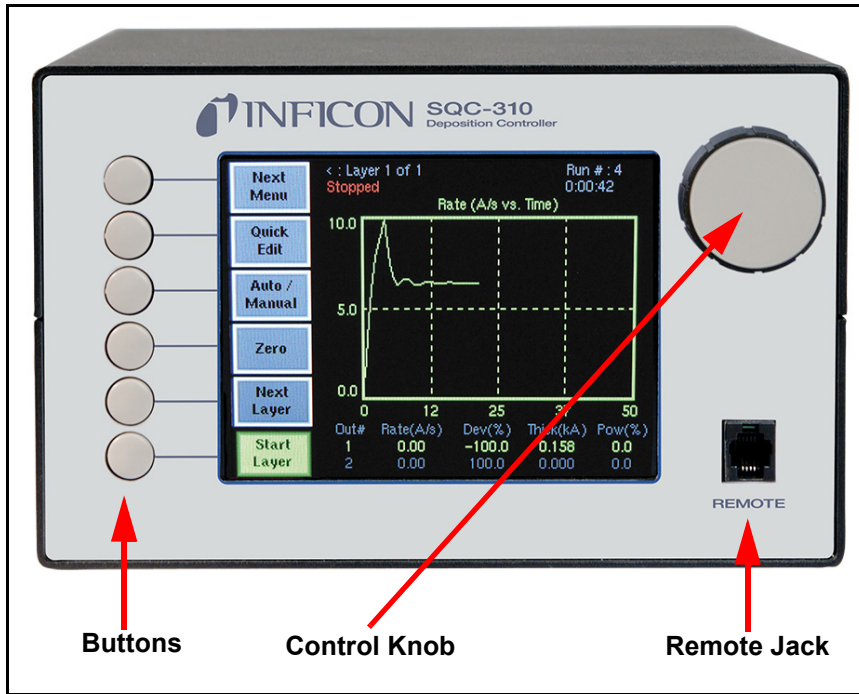

Table 2-2 Front panel controls

<b>Buttons</b>	Provide access to operation and setup menus. The functions of the buttons change to adapt to different operations and are displayed on the left of the screen.
<b>Control Knob</b>	Used to adjust values and select menu items. Press the control knob to store the current setting and move to the next parameter.
<b>Remote Jack</b>	Connection jack for the optional handheld remote controller used for manual power operation. To manually control the source using the Handheld Remote Controller, see <a href="#">section 2.6 on page 2-7</a> for installation details.

## 2.3 Rear Panel

Figure 2-2 Rear panel

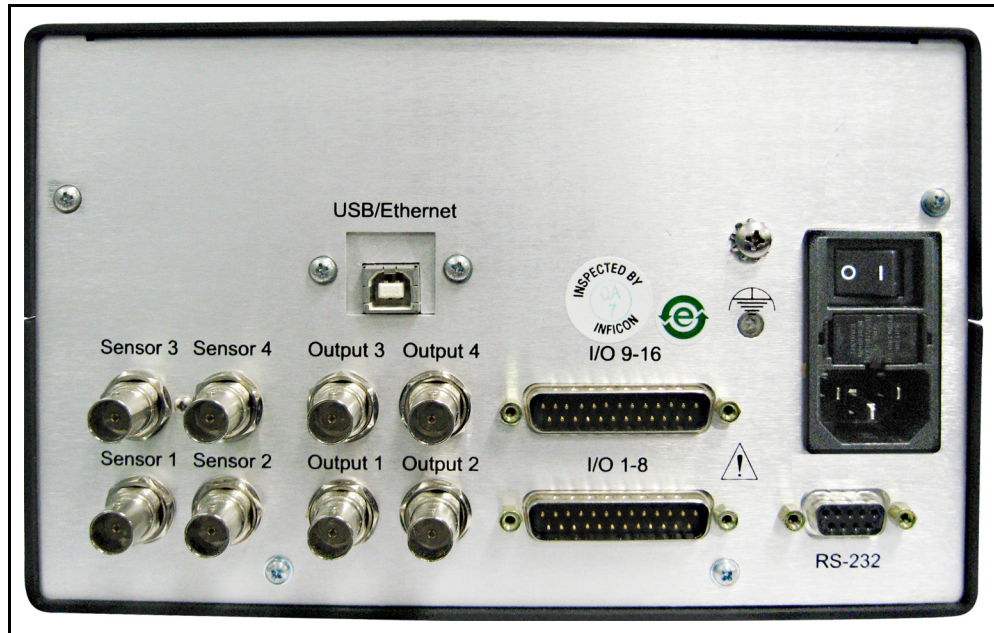



Table 2-3 Rear panel connections

<b>Sensor 1 and 2</b>	BNC connection to the oscillators for sensor 1 and 2 (see <a href="#">section 2.4 on page 2-5</a> ).
<b>Output 1 and 2</b>	BNC connection to the source power supply control voltage input.
<b>I/O 1-8</b>	25 Pin D-sub connection for 8 relays (outputs) and 8 digital inputs. For use with external equipment (see <a href="#">section 2.8 on page 2-11</a> ).
<b>RS-232 USB or Ethernet</b>	Connection to a computer for programming and data acquisition. RS-232 and USB are standard. Ethernet option replaces USB.
<b>Sensor 3 and 4 Output 3 and 4 I/O 9-16</b>	These Sensor, Output, and I/O Ports are optional with SQC-310 and standard with SQC-310C.
	Ground terminal for common system and cable grounding.
<b>Power Input and Fuse</b>	<p>Connects to mains power. SQC-310 automatically detects mains voltages of 100 to 120 and 200 to 240 V (ac), 50/60 Hz.</p> <p> <b>WARNING</b></p> <p><b>Only use a power cable and fuse of the specified rating (refer to <a href="#">section 1.4.5, Power, on page 1-7</a>).</b></p>

## 2.4 System Connections

Figure 2-3 System connections

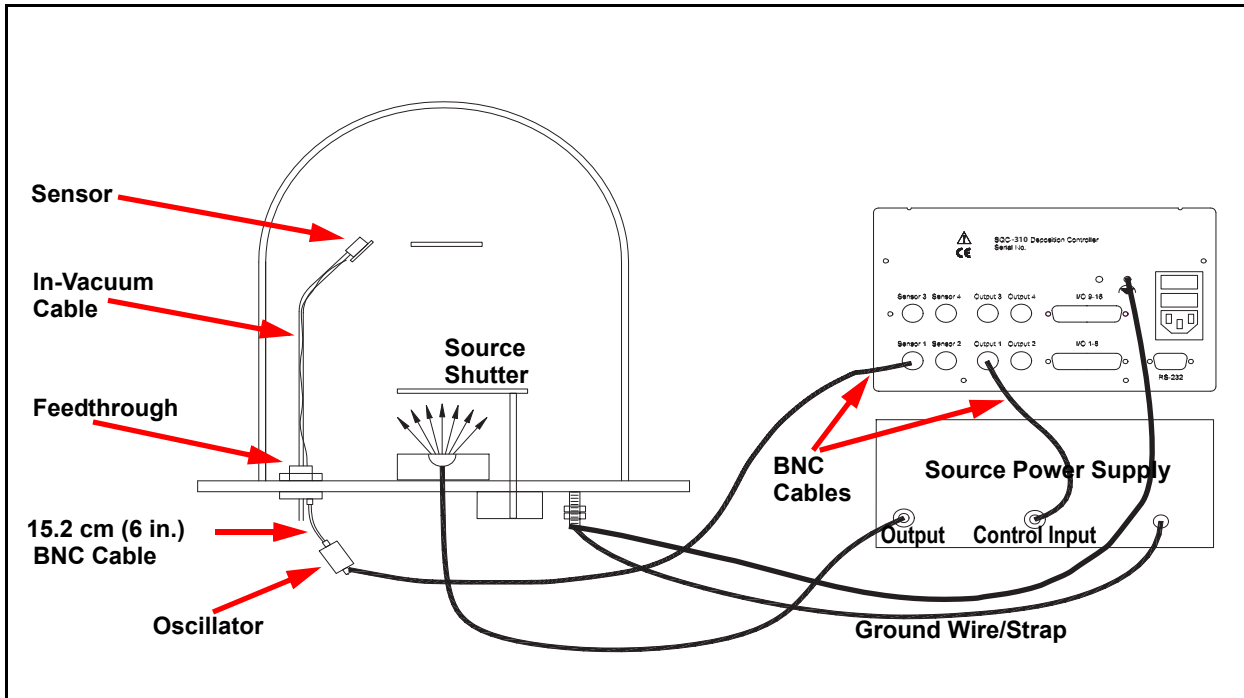

Table 2-4 System components

<b>Sensor</b>	Holds the quartz crystal used to measure rate and thickness. Crystals must be replaced regularly.
<b>In-Vacuum Cable</b>	A coaxial cable that connects the sensor to the feedthrough.
<b>Feedthrough</b>	Provides isolation between vacuum and atmosphere for electrical connections, water, air, and/or purge gas tubes.
<b>15.2 cm (6 in.) BNC Cable</b>	Provides a flexible connection from the feedthrough to the oscillator.
<b>Oscillator</b>	Contains the electronics to oscillate the quartz crystal. Total cable length to the crystal should be under 102 cm (40 in.).
<b>Sensor Input BNC Cable</b>	Connects the oscillator to the SQC-310 sensor input. Lengths up to 22.8 m (75 ft.) are acceptable.
<b>Control Output BNC Cable</b>	Connects the SQC-310 output to the source power supply control voltage input.
<b>Ground Wire/Strap</b>	A wire or strap that connects the vacuum system to the SQC-310 ground terminal. The wire or strap is important for noise rejection (see <a href="#">section 2.5</a> ).

## 2.5 Ground Requirements

Low impedance wires or straps must be used to connect the chassis of all control components to a common ground point connected to earth ground (see [section 2.5.1](#) for the earth ground requirement).

Solid copper straps at least 12.7 mm (0.5 in.) wide and approximately 0.56 mm (0.022 in.) thick (as short as possible) are recommended where RF is present. This is particularly important in high-noise e-beam systems (see [Figure 2-4](#) for the recommended grounding method).

The oscillator is grounded through the BNC cables, and the crystal sensor is typically grounded to the wall of the vacuum system. If the sensor feedthrough is not properly grounded to the vacuum system, connect a copper strap between the sensor feedthrough and the common ground point for the system components.

Figure 2-4 System grounding diagram

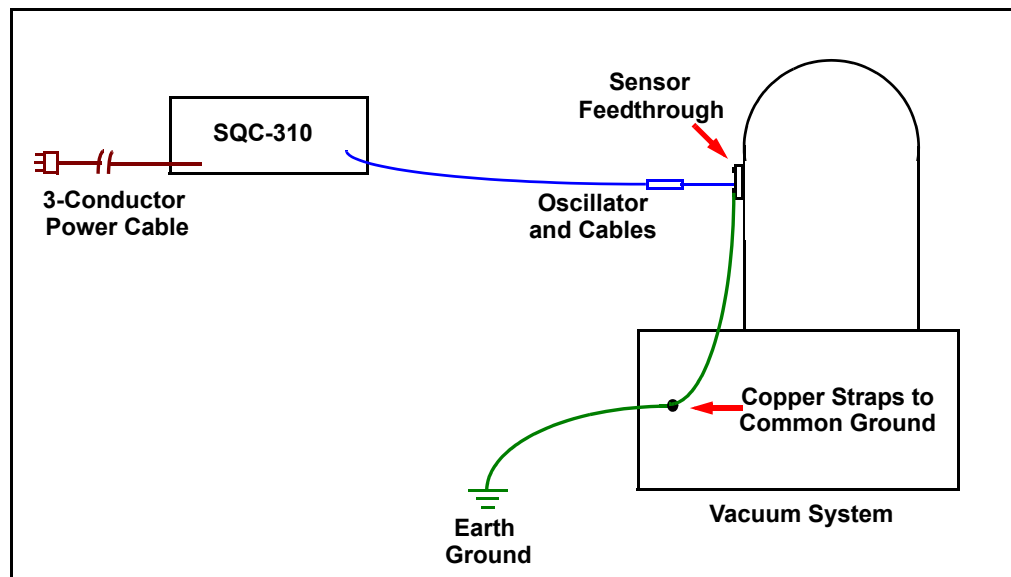

## 2.5.1 Establishing Earth Ground



### **WARNING - Risk Of Electric Shock**

**Follow local electrical regulations and codes.**

- 1 Install two 3 m (10 ft.) long copper-clad steel ground rods into the soil, spaced at least 1.9 m (6.2 ft.) apart. The ideal distance between the rods is twice the rod length.
- 2 Pour a solution of magnesium sulfate or copper sulfate around each rod to reduce resistance to earth ground.
- 3 Test the ground rods using a ground resistance tester specifically designed for that purpose.

**NOTE:** Do not use a common ohmmeter.

- 4 After verifying that a good earth ground has been achieved, connect the rods together using solid copper straps at least 76 mm (3 in.) wide and approximately 0.9 to 1.3 mm (0.05 in.) thick, keeping the strap as short as possible.

**NOTE:** Do not use braided wire. Use a solid copper strap.

## 2.6 Handheld Remote Controller

The Handheld Remote Controller (PN 782-900-017) provides the capability of adjusting output power remotely when SQC-310 is in Manual mode.

Figure 2-5 Handheld Remote Controller

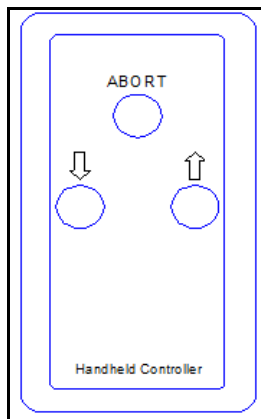

To install the Handheld Remote Controller, attach the cable from the Handheld Remote Controller to the Remote Jack on the SQC-310 front panel.

The front panel control knob or the Handheld Remote Controller can be used to increase (↑) or decrease (↓) output power. Pressing **Abort** on the Handheld Remote Controller stops the layer and returns output power to 0%.

## **2.7 Rack Mount**

The procedure below provides instructions for installing the SQC-310 rack mount kit. SQC-310 is designed to mount in a standard 48.3 cm (19 in.) rack, using optional rack mount kits, or can be used on a benchtop.

2 rack mount kits are available:

- ◆ Full Rack Extender (PN 782-900-007)
- ◆ Rack Adapter (PN 782-900-016)

### **2.7.1 Full Rack Extender**

The optional Full Rack Extender (PN 782-900-007) mounts a single SQC-310 into a full-width 48.3 cm (19 in.) rack space.

#### **2.7.1.1 Inventory**

- ◆ 2 - rack mount ears
- ◆ 2 - large black aluminum panels
- ◆ 2 - small black aluminum panels
- ◆ 2 - hex shoulder screws
- ◆ 8 - small flat head screws
- ◆ 4 - large flat head screws

### 2.7.1.2 Installation

- 1 Assemble the extender. Use the 8 small flat head screws to connect the two small black aluminum panels and two large black aluminum panels (see [Figure 2-6](#)).

Figure 2-6 Assembly of extender

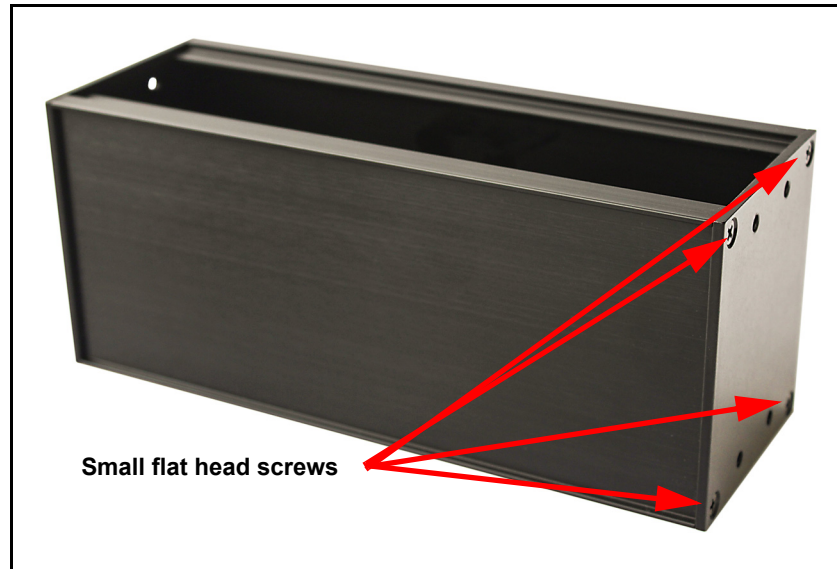

- 2 Install hex shoulder screws. From inside the extender, thread two hex shoulder screws on one side, closest to the front of SQC-310. Continue to thread the screws until the threads are completely exposed (see [Figure 2-7](#) and [Figure 2-8](#)).

Figure 2-7 Installing hex shoulder screws - inside view





Figure 2-8 Installing hex should screw - overall view



- 3** Attach the extender. Align the extender with SQC-310 to fit the rack. The hex shoulder screws installed in step 2 should align with the two large threaded holes in SQC-310. Tighten the hex shoulder screws to secure the extender to SQC-310.
- 4** Install the rack mount ears. Using the 4 large flat head screws provided, install the rack mount ears on the outer ends of the controller assembly. Install one rack mount ear to SQC-310, and the other to the extender.
- 5** Mount SQC-310. Slide the entire assembly into an empty 2U rack-mount space (8.9 cm [3.5 in.] H x 48.3 cm [19 in.] W). Secure the assembly with four rack screws (not provided).

## 2.7.2 Rack Adapter

The optional Rack Adapter (PN 782-900-016) mounts two SQC-310 controllers side-by-side in a full-width 48.3 cm (19 in.) rack space.

### 2.7.2.1 Inventory

- ◆ 2 - rack mount ears
- ◆ 1 - rear mount coupler
- ◆ 4 - 4-40 pan head screws with washers
- ◆ 4 - 10-32 flat head screws

### 2.7.2.2 Installation

- 1 Align the two controllers side by side, as though installed in the rack. Remove the two adjacent screws on the rear panel of each SQC-310.

**NOTE:** These screws are no longer needed and may be discarded.

- 2 Install the rear mount couplers. Using the 4 pan head screws and washers provided, install one side of the rear mount coupler to each SQC-310. Do not fully tighten the screws until all screws are installed.
- 3 Install the rack mount ears. Using the 4 flat head screws provided, install the rack mount ears on the outer ends of the controller assembly. One rack mount ear should be installed on each SQC-310.
- 4 Mount the SQC-310 assembly. Slide the assembly into an empty 2U rack-mount space (8.9 cm [3.5 in.] H x48.3 cm [19 in.] W). Secure the assembly with four rack screws (not provided).

## 2.8 I/O Connections

A 25-pin, D-sub connector, located on the SQC-310 rear panel, provides Input/Output connections.

Inputs can be activated by connecting to a switch and shorting to ground, or they can be driven by a TTL compatible signal. TTL signals can be programmed to be either active high or active low, as needed.



### CAUTION

---

**These are *not* isolated inputs. The voltage level applied must be limited to between 0 and +5 V with respect to ground.**

---



### WARNING

---

**Output relays are rated for 30 V (rms) or 30 V (dc), 2 A maximum.**

---

The pin assignments for the rear panel mounted I/O connector are displayed in [Figure 2-9](#) and [Table 2-5](#)

Figure 2-9 Rear panel I/O pin assignments

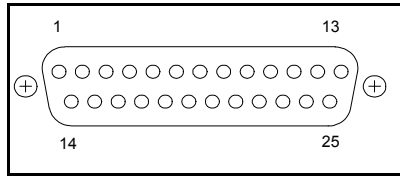

Table 2-5 I/O connector wiring

Relay	Pins		Input	Pins
Relay 1	14,15		Input 1	16
Relay 2	1,2		Input 2	17
Relay 3	3,4		Input 3	18
Relay 4	5,6		Input 4	19
Relay 5	7,8		Input 5	20
Relay 6	9,10		Input 6	21
Relay 7	11,12		Input 7	22
Relay 8	13,25		Input 8	23
			Ground	24

**NOTE:** Relays 9 to 16 and inputs 9 to 16 use the same connector pins as found on the second rear panel I/O connector (if available) in the same sequential order.

## 2.9 Interfacing SQC-310 to CI-100 Crucible Indexer

This section assumes an understanding of the setup and operations for SQC-310 and CI-100 Crucible Indexer. See [Chapter 3, Operation](#) for more SQC-310 operations information.

### 2.9.1 BCD I/O Setup

BCD wiring is suggested over Individual I/O wiring because it uses fewer relays.

The wiring below interfaces the SQC-310 I/O connector to the CI-100 BCD I/O connector for controlling an 8 pocket source.

<u>SQC-310</u>	<u>CI-100 BCD I/O</u>	
Pin 14----->-----	Pin 1	OutX Pocket Bit1
Pin 1 ----->-----	Pin 2	OutX Pocket Bit2
Pin 3 ----->-----	Pin 7	OutX Pocket Bit3
Pin 16 -----<-----	Pin 5	OutX Pocket Ready
Pin 15,2,4-----	Pin 6	Common
	Short Pin 3 to Pin 9	Interlock
	Short Pin 4 to Pin 8	Pocket Ready A

On the CI-100 rear panel: set Select Switch #5 up and #7 down.

On the SQC-310 **System Menu** >> **Sensors & Sources** (see [section 3.12.3 on page 3-36](#)) set up the source with:

- ◆ Number of Positions: 8
- ◆ Control Type: BCD
- ◆ Feedback Type: In Position
- ◆ Indexer Delay: 5 seconds

## 2.9.2 Individual (Binary - as defined by CI-100) I/O Setup

To use Individual wiring between CI-100 and SQC-310 for a four pocket crucible:

<u>SQC-310</u>	-----	<u>CI-100 Binary I/O</u>	
Pin 1,3,5,14,24	-----	Pin 1, 2	Common
Pin 16	-----<-----	Pin 3	OutX Pocket Ready
Pin 15	----->-----	Pin 4	OutX Pocket 1
Pin 2	----->-----	Pin 6	OutX Pocket 2
Pin 4	----->-----	Pin 8	OutX Pocket 3
Pin 6	----->-----	Pin 10	OutX Pocket 4

On the CI-100 rear panel, set Select Switch #5 down.

On the SQC-310 **System Menu** >> **Sensors & Sources** (see [section 3.12.3 on page 3-36](#)) set up the source with:

- ◆ Number of Positions: 4
- ◆ Control Type: Individual
- ◆ Feedback Type: In Position
- ◆ Indexer Delay: 5 seconds

## 2.10 Interfacing SQC-310 to INFICON EBS-530 Electron Beam Sweep Controller

This procedure describes how to use the SQC-310 Source Indexer function, to control EBS-530 pattern selection (refer to [section 3.12.3, Sensors and Sources Menu, on page 3-36](#)).

**NOTE:** EBS-530 allows up to 32 patterns; however, SQC-310 cannot select patterns numbered above 16.

- 1 In the SQC-310 **System Menu >> Sensors & Sources**, select a **Source** (1 to 4) and then select the following Source parameters and values:

Number of Positions . . . . . 2 to 16  
 Control Type . . . . . BCD  
 Feedback Type . . . . . None  
 Indexer Delay . . . . . 1 seconds

**NOTE:**

- ◆ Number of Positions should equal the desired number of EBS-530 sweep patterns to be selected by SQC-310.
- ◆ Two sweep patterns will require one SQC-310 relay.
- ◆ Three or four sweep patterns will require two SQC-310 relays.
- ◆ Five to eight sweep patterns will require three SQC-310 relays.
- ◆ Nine to 16 sweep patterns will require four SQC-310 relays.

SQC-310 will assign up to four relays named **Sourcen\_BCD\_Bitn**, displayed in the **Relay Menu** (refer to [section 3.12.1 on page 3-27](#)). These relays will be connected to the corresponding PSEL pattern select inputs of the EBS-530 (see [Table 2-6](#)), SQC-310 to EBS-530 wiring chart.

**NOTE:** **Sourcen\_BCD\_Bitn** indicates the number of the Source selected for EBS-530 sweep control and the BCD bit (0, 1, 2, or 3) that the relay corresponds to.

- 2 For each **Film**, set the **Pocket** parameter value to the desired sweep pattern number (refer to [section 3.11 on page 3-18](#)).
- 3 In the SQC-310 **Logic Menu** (refer to [section 3.12.2 on page 3-30](#)) create the following two logic statements:
  - ◆ IF **Source n** Enabled AND NOT Rotate Pocket AND NOT Crystal Verify AND NOT Stopped AND **Inputn** THEN **Relayn**
  - ◆ IF NOT **Inputn** THEN Sound (Attention/ Alert/ Alarm) Alarm

**NOTE:**

- ◆ **Source n** is the SQC-310 Source previously selected for EBS-530 sweep control.
- ◆ **Inputn** is any available SQC-310 input. The same input is used in both logic statements. This input will be connected to the EBS-530 relay named **OUT\_SWP\_READY**(see Table 2-6) SQC-310 to EBS-530 wiring chart.
- ◆ **Relayn** is any available SQC-310 relay. This relay will be connected to the EBS-530 input named **SWP\_ON\_OFF** (see Table 2-6) SQC-310 to EBS-530 wiring chart.

The sweep for the selected sweep pattern will be turned on if the first logic statement is true. If the first logic statement is not true and the second logic statement is true, sweep will be off and an Alarm message will be displayed by SQC-310 to indicate that EBS-530 is either not in I/O mode or an EBS-530 error has occurred.



**CAUTION**

**Sweep will be off during the following conditions:**

- ◆ **Idle at non-zero power (sweep is on during Idle ramp)**
- ◆ **Manual mode with Process/Layer Stopped**

- 4 Construct a wiring harness to interface SQC-310 with EBS-530 (see Table 2-6, SQC-310 to EBS-530 wiring chart).

Table 2-6 SQC-310 to EBS-530 wiring chart

SQC-310 Function	EBS-530 Function	SQC-310 I/O Connector (Refer to section 2.8 on page 2-11 for pinout)	EBS-530 Digital I/O Connector
Relay: BCD Bit 0	Input <b>PSEL-0</b> : Pattern Select Bit 0	Either pin of relay named <b>Sourcen_BCD_Bit0</b>	Pin 7
Relay: BCD Bit 1	Input <b>PSEL-1</b> : Pattern Select Bit 1	Either pin of relay named <b>Sourcen_BCD_Bit1</b>	Pin 2
Relay: BCD Bit 2	Input <b>PSEL-2</b> : Pattern Select Bit 2	Either pin of relay named <b>Sourcen_BCD_Bit2</b>	Pin 14
Relay: BCD Bit 3	Input <b>PSEL-3</b> : Pattern Select Bit 3	Either pin of relay named <b>Sourcen_BCD_Bit3</b>	Pin 12
Relay: Used in Logic Statement	Input <b>SWP_ON_OFF</b> : Sweep is turned on if I/O mode and Interlock inputs are active and logic statement is true.	Either pin of relay used in logic statement	Pin 6

PN 074-550-P1E

Table 2-6 SQC-310 to EBS-530 wiring chart

SQC-310 Function	EBS-530 Function	SQC-310 I/O Connector (Refer to section 2.8 on page 2-11 for pinout)	EBS-530 Digital I/O Connector
Relay Common	Input Common <b>IN_COM</b>	Remaining pins of <b>Sourcen_BCD</b> relays. Remaining pin of relay used in logic statement	Pin 1
N/A	Input <b>REM_LOC</b> : Required I/O mode is activated by continuity between pins 3 and 1. Front panel pattern selection is disabled when I/O control mode is active.	N/A	Pin 3
N/A	Input <b>IL OK</b> : Required Interlock is activated by continuity between pins 8 and 1. To protect e-beam coils, use cooling water on signal to activate this input.	N/A	Pin 8
Input: Used in Logic Statements	Relay <b>OUT_SWP_READY</b> : Indicates I/O mode is active and no errors are present.	Input used in logic statements	Pin 9
Input Common	Relay Common <b>OUT_COM</b>	Pin 24	Pin 5



---

## Chapter 3 Operation

---

### 3.1 Thin Film Deposition Overview

This section provides general background information of the steps involved in a thin film deposition process and the operation of SQC-310.

#### 3.1.1 Definitions

Several key terms will be used repeatedly throughout this manual. It is important to understand each of these terms.

**Material:** A physical material to be deposited. A database of 100 materials is stored in SQC-310. Three parameters completely define a material: **Name**, **Density**, and **Z-Ratio** (also called **Z-Factor**). Common materials, densities, and Z-Ratios are listed in [Appendix A](#).

**Film:** A film describes in detail how a material will be deposited. It includes the material definition and all of the preconditioning, deposition, and postconditioning variables necessary to accurately deposit the material. Because the film definition does not include rate and thickness information, a single film can be used in several different layers and processes. SQC-310 stores up to 50 films.

**Layer:** Layers are the basic building blocks of processes. A layer consists of a film and the thickness and rate setpoints for that stage of the process. Layers also define which outputs and sensors will be used at that point in the process.

Codeposition of multiple films occurs when more than one output is active during a layer. SQC-310 stores up to 1000 layers.

**Process:** A process is a sequence of layers to be deposited. SQC-310 stores up to 100 processes.

**Phase:** A phase is a step or stage in the deposition cycle. Preconditioning phases include Ramp 1, Soak 1, Ramp 2, and Soak 2. Deposit phases include Indexer Rotate, Shutter Delay, Deposition, and Deposition Rate Ramps. Postconditioning phases include Feed Ramp, Feed, and Idle Power.

SQC-310 stores the recipes and provides the operating functions required to control thin film deposition processes. A typical thin film deposition cycle is displayed in [Figure 3-1](#).

### 3.1.2 Thin Film Deposition Phases

Figure 3-1 Typical thin film deposition cycle

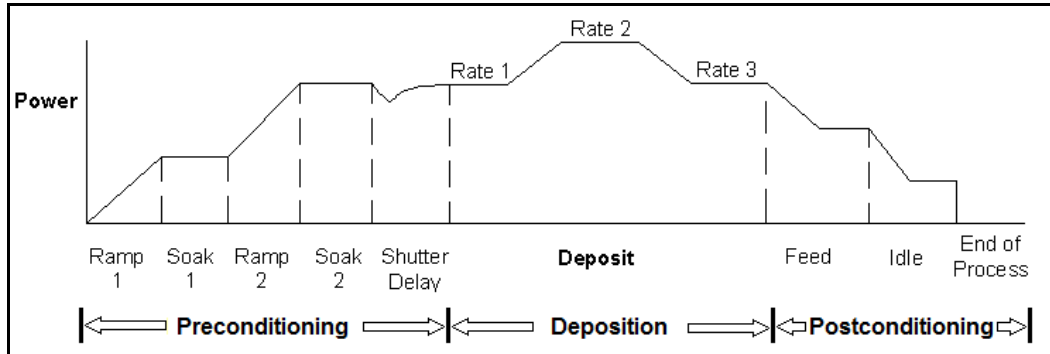

The cycle can be broken into three distinct phases:

- ◆ Preconditioning (ramp/soak)
- ◆ Deposition
- ◆ Postconditioning (feed/idle)

During preconditioning, power is supplied in steps to prepare the evaporation source for deposition. Once the material is near the desired deposition rate, material deposition begins.

During deposition, the PID loop adjusts the evaporation source power as required to maintain the desired rate. In codeposition, multiple films can be deposited simultaneously.

When the desired thickness is reached, the evaporation source is set to idle power. At this point the process may be complete, or deposition of another layer may begin.

### 3.2 SQC-310 Menu Overview

When turned on, SQC-310 briefly displays the model number (SQC-310 or SQC-310C) and firmware version information, then the Main screen is displayed (see Figure 3-2).

Three menus on the Main Screen control SQC-310 operation. The buttons associated with each of these menus provides access to sub menus (see Figure 3-3). This chapter describes the function of each setting in each menu. It is arranged by Main Screen menus, then by major sub menus.

**NOTE:** If prompted for a password, use the buttons along the left of the screen to enter the password. The top button is **1**, the bottom button is **6**. Pressing the control knob is **7**.

Figure 3-2 Main screen

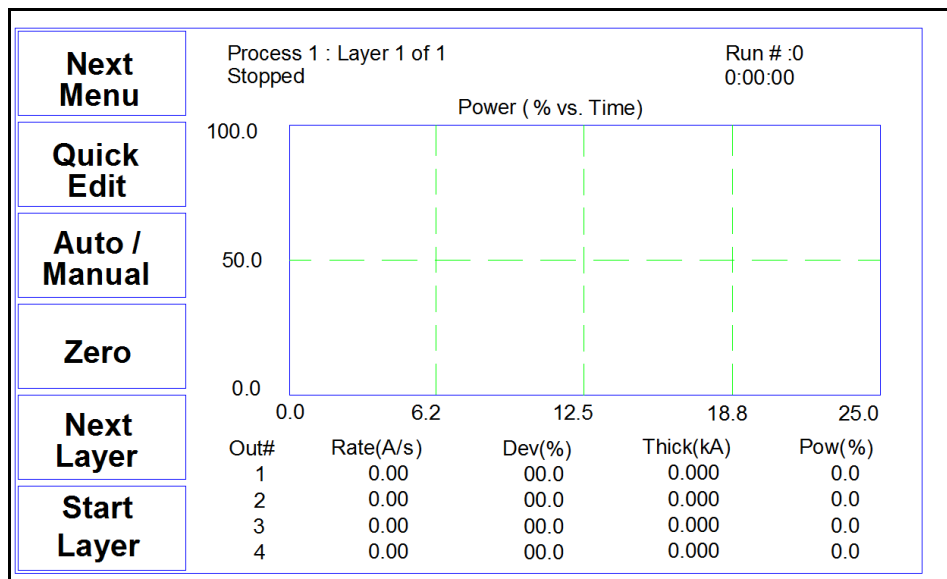

The first line of the Main screen displays the name of the currently selected process. After the process name is the layer that will run when **Start Layer** is pressed, and the total number of layers in the process. Run # displays the number of times this process has been run.

The second line of the Main screen is a status line. It displays the current phase of the deposition cycle and other status or error messages. When the process is running, the right side of this line displays the process elapsed time.

Three graphs are available for display: **rate**, **rate deviation**, or **output power**. The graphs scale the vertical axis and scroll the horizontal axis based on the data displayed.

Below the graph are two lines that display deposition readings (four lines for SQC-310 equipped with option card or for SQC-310C). This section displays current rate, rate deviation, thickness, and output power. Alternatively, the section can display current rate, rate setpoint, thickness, and thickness setpoint.

The functions of the buttons change to adapt to different operations and are displayed on the left of the screen. Press **Next Menu** to display alternate Main screen menus (see Figure 3-3).

Figure 3-3 Alternate Main screen menus

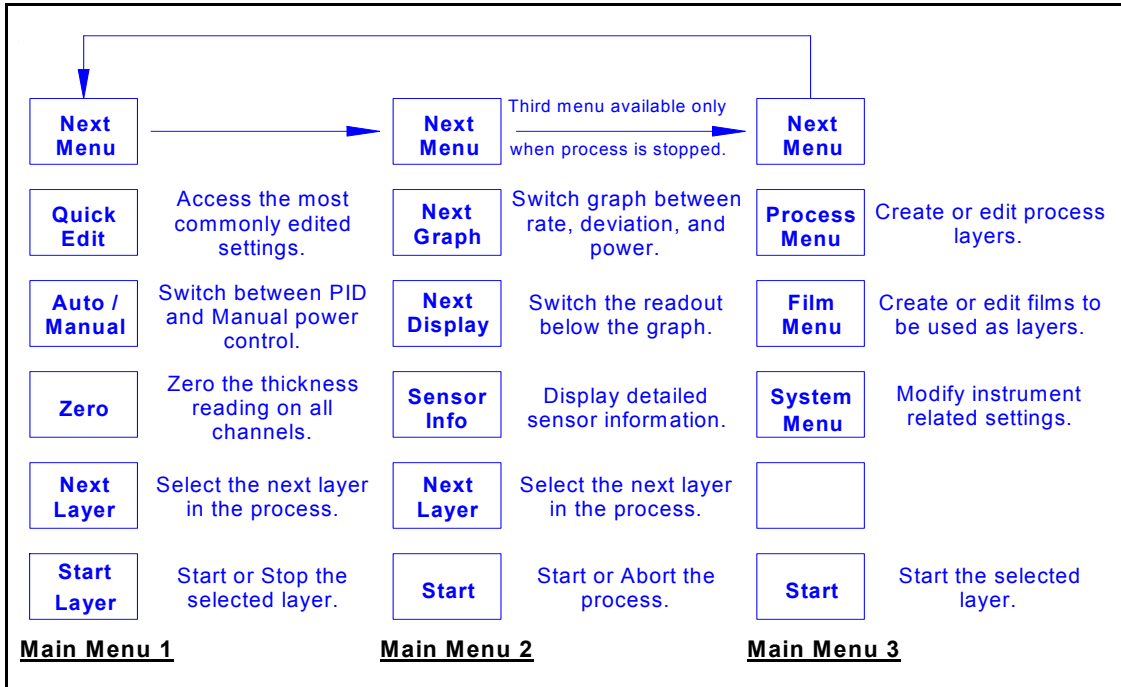

**Main Menu 3** provides access to functions that can redefine a process and is available only when the process is stopped.

Spend some time now moving between the three menus. Pay particular attention to the effects that the **Main Menu 2** selections have on the display.

### 3.3 Main Screen, Menu 1

Table 3-1 describes the function of each button on Main screen, Menu 1.

Table 3-1 Main screen, Menu 1 buttons

<b>Next Menu</b>	Sequences through each of the three Main screen menus.
<b>Quick Edit</b>	Displays the Quick Edit menu of commonly changed process values. If this function is not displayed, the active process has no layers defined.
<b>Auto / Manual</b>	<p>Toggles between Auto and Manual power control. When Auto/Manual is displayed, output power is set by SQC-310 to achieve the programmed deposition rate. When Manual/Auto is displayed, the control knob or optional Handheld Remote Controller sets the output power.</p> <p><b>NOTE:</b> For optimal performance in manual power control use the Handheld Remote Controller. Controlling quick responding sources (for example, e-beam sources) may be difficult using the control knob.</p>
<b>Zero</b>	Clears the thickness reading. Useful for resetting or extending the current deposition layer.
<b>Next Layer</b>	Sequences through each process layer. Press this button to start or restart the process at any layer. Only displayed when the process is stopped.
<b>Start Layer</b>	Each layer in a process can be defined as Auto Start or Manual Start. Auto Start layers begin immediately on completion of the previous layer. Manual Start layers require <b>Start Layer</b> to be pressed. Only displayed when waiting to start a Manual Start layer.
<b>Start/Stop Layer</b>	Starts or halts the current process. Sets all outputs to zero.

### 3.4 Main Screen, Menu 2

Table 3-2 describes the function of each button on Main screen, Menu 2.

Table 3-2 Main screen, Menu 2 buttons

<b>Next Menu</b>	Sequences through each of the three Main screen menus.																																																						
<b>Next Graph</b>	Sequences through the graph options for the Main screen. Choose between <b>rate</b> , <b>rate deviation</b> , or output <b>power</b> graphs. The Y-axis of the rate deviation graph can be scaled in the System Parameters menu. A fourth display screen displays rate, thickness, and power in large text format for easy viewing.																																																						
<b>Next Display</b>	Toggles between data display options at the bottom of the Main screen. The first display option displays rate, rate deviation, thickness, and power readings. The second display option displays rate, rate setpoint, thickness and thickness setpoint.																																																						
<b>Sensor Info</b>	Replaces the Main screen with the Sensor screen. <div style="border: 1px solid black; padding: 10px; margin: 10px 0;"> <table border="1" style="width: 100%; border-collapse: collapse;"> <tr> <td style="text-align: center; width: 10%;"><b>Exit</b></td> <td style="width: 15%;"><b>Sensor #</b></td> <td style="width: 15%;">1</td> <td style="width: 15%;">2</td> <td style="width: 15%;">3</td> <td style="width: 15%;">4</td> </tr> <tr> <td></td> <td><b>Crystal #</b></td> <td>--</td> <td>--</td> <td>--</td> <td>--</td> </tr> <tr> <td></td> <td><b>Status</b></td> <td>ON</td> <td>OFF</td> <td>OFF</td> <td>OFF</td> </tr> <tr> <td></td> <td><b>Freq</b></td> <td>5949983.66</td> <td>5950000.00</td> <td>5950000.00</td> <td>5950000.00</td> </tr> <tr> <td></td> <td><b>Life</b></td> <td>95.00%</td> <td>95.00%</td> <td>95.00%</td> <td>95.00%</td> </tr> <tr> <td></td> <td><b>Rate</b></td> <td>0.00</td> <td>--</td> <td>--</td> <td>--</td> </tr> <tr> <td></td> <td><b>Thick</b></td> <td>0.000</td> <td>--</td> <td>--</td> <td>--</td> </tr> <tr> <td></td> <td><b>CQ Count</b></td> <td>--</td> <td>--</td> <td>--</td> <td>--</td> </tr> <tr> <td></td> <td><b>CS Total</b></td> <td>--</td> <td>--</td> <td>--</td> <td>--</td> </tr> </table> </div>	<b>Exit</b>	<b>Sensor #</b>	1	2	3	4		<b>Crystal #</b>	--	--	--	--		<b>Status</b>	ON	OFF	OFF	OFF		<b>Freq</b>	5949983.66	5950000.00	5950000.00	5950000.00		<b>Life</b>	95.00%	95.00%	95.00%	95.00%		<b>Rate</b>	0.00	--	--	--		<b>Thick</b>	0.000	--	--	--		<b>CQ Count</b>	--	--	--	--		<b>CS Total</b>	--	--	--	--
<b>Exit</b>	<b>Sensor #</b>	1	2	3	4																																																		
	<b>Crystal #</b>	--	--	--	--																																																		
	<b>Status</b>	ON	OFF	OFF	OFF																																																		
	<b>Freq</b>	5949983.66	5950000.00	5950000.00	5950000.00																																																		
	<b>Life</b>	95.00%	95.00%	95.00%	95.00%																																																		
	<b>Rate</b>	0.00	--	--	--																																																		
	<b>Thick</b>	0.000	--	--	--																																																		
	<b>CQ Count</b>	--	--	--	--																																																		
	<b>CS Total</b>	--	--	--	--																																																		
<b>Next Layer</b>	Sequences through each process layer. Press <b>Next Layer</b> to start or restart the process at any layer.																																																						
<b>Start Layer</b>	Each layer in a process can be defined as Auto Start or Manual Start. Auto Start layers begin immediately on completion of the previous layer. Manual Start layers require <b>Start Layer</b> to be pressed. Only displayed when waiting to start a Manual Start layer.																																																						
<b>Start/Reset</b>	Starts or halts the current process. Sets all outputs to zero.																																																						

### 3.5 Main Screen, Menu 3

Menu 3 can be accessed only while the process is stopped. This menu displays process, film, and system setup parameters that cannot be altered while a process is running.

To display and edit these parameters:

- 1 Stop the process.
- 2 Edit the parameters values.
- 3 Restart the process at the desired layer.

Table 3-3 describes the function of each button on Main screen, Menu 3.

Table 3-3 Main screen, Menu 3 buttons

<b>Next Menu</b>	Sequences through each of the three Main screen menus.
<b>Process Menu</b>	A process is a sequence of layers of deposited film(s). The Process Menu allows process layers to be created and edited.
<b>Film Menu</b>	A film consists of a material plus the setup information necessary to deposit that material. Settings on the Film menu include pre/postconditioning, deposition error controls, and the physical chamber setup for that material.
<b>System Menu</b>	System parameters control the overall operation of SQC-310. Tooling, crystal frequency, and operating modes are found on the System Parameters menu.
<b>Start/Reset</b>	Starts or halts the current process. When halted, all outputs are set to zero
<b>View Logic</b>	View Logic is a read-only screen while a process is running. This displays logic statements as true (shown in green text) or false (shown in red text) at any point in the process.

The remainder of this chapter provides a detailed explanation of each sub menu and its settings.

### 3.6 Quick Edit Menu

The Quick Edit menu is found on the Main Screen under Main Menu 1. It provides access to the most commonly adjusted parameters for the current process and layer (see Figure 3-4).

Figure 3-4 Quick Edit menu

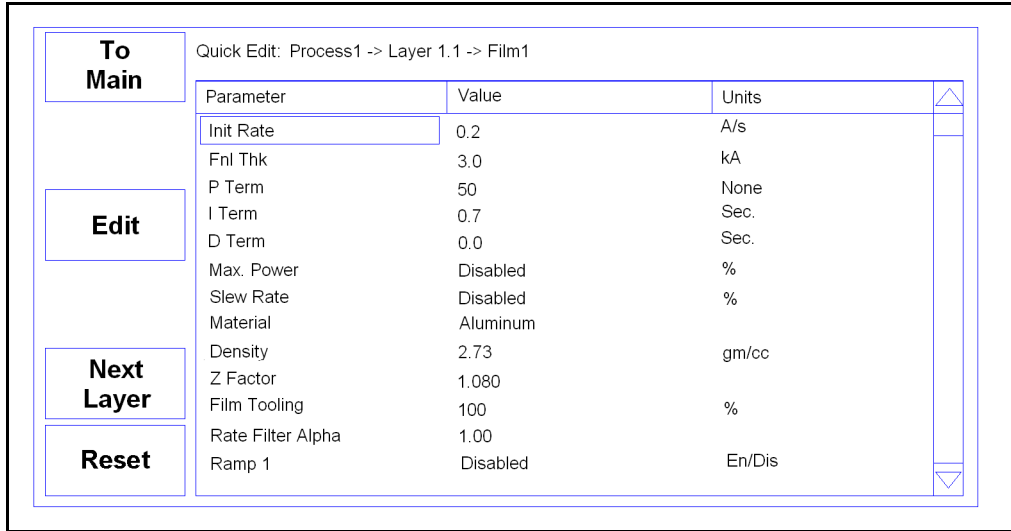

Table 3-4 Quick Edit menu buttons

<b>To Main</b>	Returns to the Main screen Menu 1.
<b>Edit</b>	Opens the selected parameter for edit. Button functions change to: <b>Next:</b> Store parameter and move to next for editing. <b>Cancel:</b> Stop editing and undo changes to selected parameter. <b>Enter:</b> Stop editing and save values for selected parameter. <b>Control Knob:</b> Rotate to adjust value. Press to store value and move to next parameter.
<b>Prev Layer</b>	Displays the parameters for the previous layer in the process.
<b>Next Layer</b>	Displays the parameters for the next layer in the process.
<b>Reset</b>	Displayed only when a layer is in process. Stops the layer and resets the process.
<b>Control Knob</b>	Rotate the control knob counterclockwise or clockwise to change the selected parameter. Press the control knob button to select a parameter value to edit. With the parameter selected, rotate the control knob counterclockwise or clockwise to change the value. Once the desired change is made, press the control knob to save the change for the selected parameter and to automatically scroll down to the next parameter value for editing.



Quick Edit parameters are described below:

**Initial Rate:** The beginning rate of deposition for this layer. This is the target rate that the control loop tries to maintain throughout the deposition (assuming no rate ramps are used).

**Final Thickness:** The desired final thickness of this layer. The deposition phase of this layer will end when this thickness is reached.

**P Term:** The proportional term sets the gain of the control loop. High gains yield more responsive (but potentially unstable) loops. Try a value of 25, then gradually increase/decrease the value to respond to step changes in rate setpoint.

**I Term:** The integral term controls the time constant of the loop response. Try 0.5 to 1 seconds for e-beam systems, 5 to 10 s for thermal systems.

**D Term:** The differential term causes the loop to respond quickly to changes. Use 0 or a very small value to avoid oscillations.

**NOTE:** See [section 7.5, Control Loop, on page 7-5](#) for details on adjusting the PID control loop terms.

**Max Power:** The maximum output power allowed for the selected source. Power is limited to this value and a power alarm occurs if the power remains at the maximum for the time set for Power Alarm Delay.

**Slew Rate:** The maximum power change allowed on an output, in % of Full Scale per second. If power or rate ramps exceed this value, an error will occur.

**Material:** Assigns a material to the film. As materials change, their density and Z-Ratio (Z-Factor) are updated.

**Density:** Sets the density for this material. Material density has a significant impact on deposition calculations.

**Z-Factor:** Sets the Z-Ratio, which is the acoustic impedance of the quartz crystal to that of the deposited material. It is an empirically determined measure of the effect a material has on quartz crystal frequency change.

**Film Tooling:** Compensates for sensor sensitivity to the selected material. Use Crystal Tooling in the System menu to compensate for each sensor individually.

**Rate Filter Alpha:** Selects the amount of filtering used to display rate data. An Alpha of 1 is no filtering. An Alpha of 0.1 is heavy filtering.

**NOTE:** Low alpha values give a very stable display, but will lag actual rate readings and can hide noise problems.

**Ramp 1:** During the deposition of a layer, it may be desirable to change the deposition rate. For example, a process may require the deposition to occur at a slow rate first and then increase the rate once an initial thickness is reached. Enabling rate ramps provides that capability. Once enabled, these parameters become available:

**Start Thickness:** The deposited thickness at which the new rate will begin.

**Ramp Time:** Time allowed for the rate to change from initial rate to new rate.

**New Rate:** The rate of deposition, which is reached at the end of Ramp 1.

**Ramp 2 / Ramp 3:** Three rate ramps are available for each layer. Ramps 2 and 3 both have Start Thickness, Ramp Time, and New Rate parameters similar to those described above for Ramp 1. The Start Thickness for Ramp 2 should be greater than the Start Thickness for Ramp 1. Likewise, the Start Thickness for Ramp 3 should be greater than the Start Thickness for Ramp 2.

### 3.7 Process Menus

There are several tiers of Process menus. The first tier (see [Figure 3-5](#)) displays all processes and enables processes to be selected for editing or to be set as the active process. Scrolling and selecting a process is done by rotating the control knob.

Figure 3-5 Process Select menu

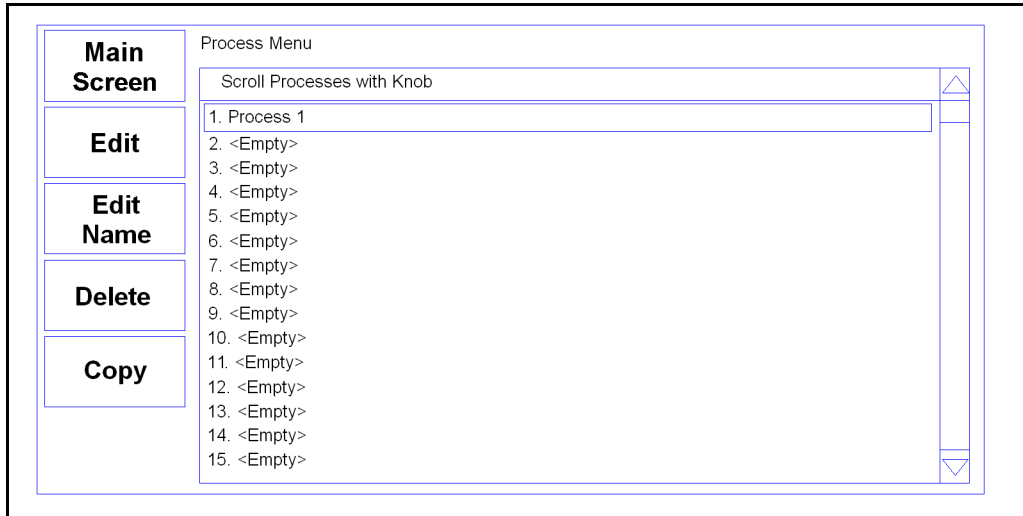

Table 3-5 Process Select menu buttons

<b>Main Screen</b>	Returns to the Main screen, Menu 3.
<b>Edit</b>	Edit displays the Layer Select menu for the selected process.
<b>Edit Name</b>	Displays the character entry screen to edit the selected process name.

Table 3-5 Process Select menu buttons (continued)

<b>Delete</b>	Deletes the selected process and all of its layers. A prompt will follow if delete is selected to safeguard against accidental process deletion.
<b>Copy/Paste</b>	Copies the selected process and all of its layers. Scroll to an Empty process and press <b>Paste</b> to paste the copied process and corresponding film name. The <b>Paste</b> button will be displayed after the <b>Copy</b> button is pressed.
<b>Create</b>	When an empty process is selected, creates a new process.
<b>Control Knob</b>	Rotate the control knob counterclockwise or clockwise to change the selected process. Press the control knob button to select a process for editing.

Selecting **Edit** on the Process Select menu displays the sequence of layers that will be deposited in the selected process (see Figure 3-6). Scrolling and selecting a layer is done by rotating the control knob.

Figure 3-6 Layer Select menu

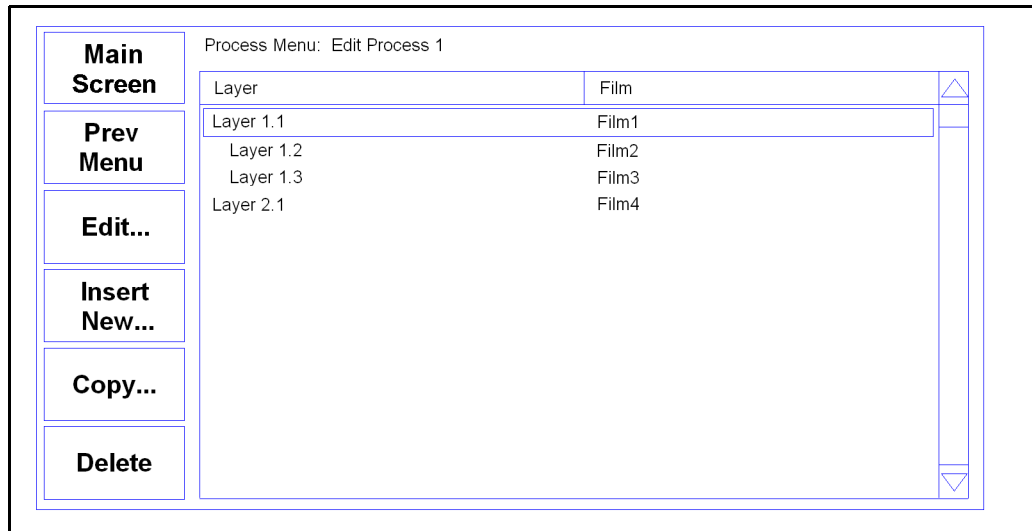

Table 3-6 Layer Select menu buttons

<b>Main Screen</b>	Returns to the Main screen Menu 3.
<b>Prev Menu</b>	Returns to the Process Select menu.
<b>Edit...</b>	Displays the Layer Edit menu for the selected layer (see Figure 3-7).

Table 3-6 Layer Select menu buttons (continued)

<b>Insert New . . .</b>	Displays the list of 50 films. Select a film, then press <b>Insert Normal</b> or <b>Insert CoDep</b> to insert the film as a new layer.
<b>Copy.../Paste...</b>	Used to develop the sequence of layers in a process.  Copies the selected layer, which can then be pasted or inserted. Pasting overwrites the selected layer. After copying, Insert is displayed. <b>Insert</b> pastes the layer above the selected layer (see <a href="#">section 3.9 on page 3-15</a> ).
<b>Control Knob</b>	Rotate the control knob counterclockwise or clockwise to change the selected layer. Press the control knob button to select a layer for editing.

### 3.8 Process Menu - Edit Layer

The Layer Edit menu is a button option on the Main screen. Each layer consists of a film, the rate, thickness, and a few other parameters needed to setup the layer. The Layer Edit menu provides access to these layer parameters (see [Figure 3-7](#)). The control knob scrolls through the list of layer parameters. When a parameter has been selected for editing, rotate the control knob to adjust value. Press the control knob to store value and move to next parameter.

Figure 3-7 Edit Layer menu

The screenshot shows a menu titled "Process Menu: Edit Process 1: Edit Layer 1.1". On the left, there are three buttons: "To Main", "Prev Menu", and "Edit". The main area contains a table with the following data:

Parameter	Value	Units
Init Rate	10.0	A/s
Final Thickness	0.100	kA
Time Setpoint	0:00:00	h:mm:ss
Thickness Setpoint	0.000	kA
Start Mode	Auto	Auto/Man.
Sensor 1	On	On/Off
Sensor 2	Off	On/Off
Source	Src1	Src1/Src2
Max. Power	90.0	%
Min. Power	0.0	%
Power Alarm Delay	99	Sec.
Slew Rate	99	%/sec
Rate Dev. Attention	0.0	%

PN 074-550-P1E

Table 3-7 Layer Edit Menu buttons

<b>To Main</b>	Returns to the Main menu.
<b>Prev Menu</b>	Returns to the Layer Select menu.
<b>Edit</b>	Opens the selected parameter for edit. Button functions change to: <b>Next:</b> Store parameter and move to next for editing. <b>Cancel:</b> Stop editing and undo changes to selected parameter. <b>Enter:</b> Stop editing and save values for selected parameter. <b>Control Knob:</b> Rotate to change value. Press the control knob to store the value and move to the next parameter.
<b>Control Knob</b>	Rotate the control knob counterclockwise or clockwise to change the selected parameter. Press the control knob to select a parameter value to edit. With the parameter selected, rotate the control knob counterclockwise or clockwise to change the value. Once the desired change is made, press the control knob to save the change for the selected parameter and to automatically scroll down to the next parameter value for editing.

A description of each parameter on the Layer Edit menu follows:

**Initial Rate:** The beginning rate of deposition for this layer. This is the target rate that the control loop tries to maintain throughout the deposition (assuming no rate ramps are used).

**Final Thickness:** The desired final thickness of this layer. The deposition phase of this layer will end when this thickness is reached.

**Time Setpoint:** Sets a time, after deposition begins, when the Time Setpoint logic event becomes true.

**Thickness Setpoint:** Sets a thickness when the Thickness Setpoint logic event becomes true.

**Start Mode:** Determines whether a layer begins automatically upon completion of the previous layer. If Manual Start is selected, the previous layer ends at its idle power and waits for the operator to press the **Start** button.

**Sensor 1-4:** Activates/Deactivates each quartz crystal sensor to be used for the selected film. If multiple sensors are assigned to a film, their readings are averaged. If multiple sensors are assigned to a film, and one fails, it is excluded from measurements. Sensors 3 and 4 will not be displayed unless the optional sensor board is installed in SQC-310 or SQC-310C is used.

**Source:** Selects the source output that is active for the selected layer.

**Max. Power:** The maximum output power allowed for the selected source. Power is limited to this value and a power alarm occurs if the power remains at the maximum for Power Alarm Delay seconds.

**Min. Power:** The minimum output power desired for the selected output. An alarm occurs if power remains below this value for Power Alarm Delay seconds.

**Power Alarm Delay:** The time that source power must remain outside the Min/Max Power settings to trigger an alarm.

**Slew Rate:** The maximum power change allowed on an output, in % of Full Scale per second. If power or rate ramps exceed this value, an error will occur.

**Rate Dev. Attention:** The % rate deviation that triggers an attention alarm. The default value of 0% disables this function.

**Rate Dev. Alert:** The % rate deviation that triggers an alert alarm. The default value of 0% disables this function.

**Rate Dev. Alarm:** The % rate deviation that triggers an alarm. The default value of 0% disables this function.

**Ramp 1:** During the deposition of a layer, it may be desirable to change the deposition rate. For example, a process may require a slow deposition rate for an initial thickness and then an increased rate once the initial thickness is reached. Enabling rate ramps provides that capability. Once enabled, the following parameters become available:

**Start Thickness:** The deposited thickness at which the new rate will begin.

**Ramp Time:** Time allowed for the rate to change from initial rate to new rate.

**New Rate:** The rate of deposition, which is reached at the end of Ramp 1.

**Ramp 2 / Ramp 3:** Three rate ramps are available for each layer. Ramps 2 and 3 both have Start Thickness, Ramp Time, and New Rate parameters similar to those described above for Ramp 1. The Start Thickness for Ramp 2 should be greater than the Start Thickness for Ramp 1. Likewise, the Start Thickness for Ramp 3 should be greater than the Start Thickness for Ramp 2.

### 3.9 Layer Copy, Insert, and Delete Menus

From the process menu, the Copy, Delete, and Insert buttons are used to build and edit a sequence of process layers.

The Layer Select menu, displays a process consisting of four layers (see Figure 3-8). The first three layers will be codeposited with Layer 1 (note the indentation of Layers 2 and 3). The fourth layer will be deposited after Layers 1 to 3 are codeposited.

Figure 3-8 Layer Select menu

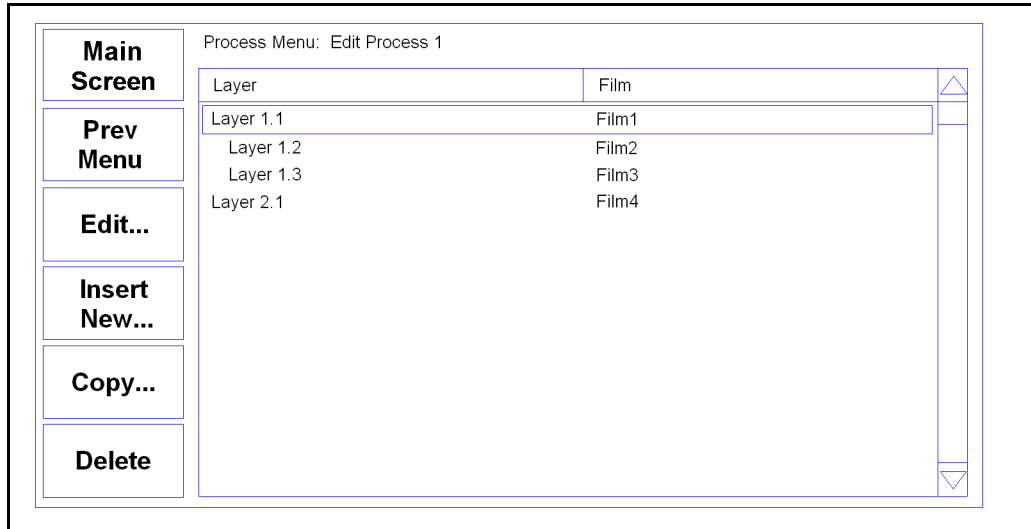

To insert a new layer, select the layer below the desired position of the new layer and press **Insert New**. The Film Select menu allows for the selection of a film to be used for this layer.

**NOTE:** Insert CoDep is only available on the codeposition model (SQC-310C).

Figure 3-9 Film Select menu

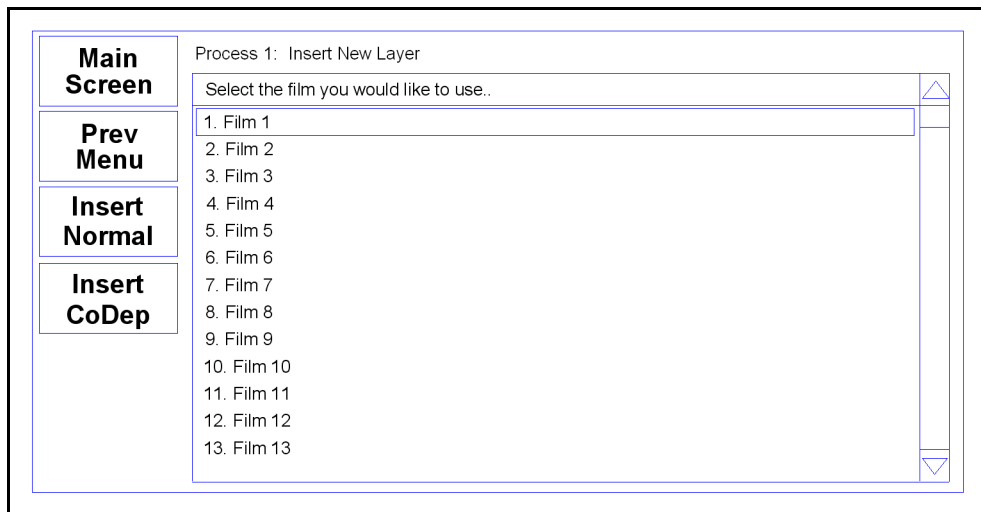

Once a film is selected, press **Paste Normal** or **Paste CoDep**. The Paste CoDep button only appears when a valid layer has been selected for inserting using SQC-310C. After the paste, the screen returns to the Layer Select menu (see Figure 3-10).

Figure 3-10 Layer Select menu

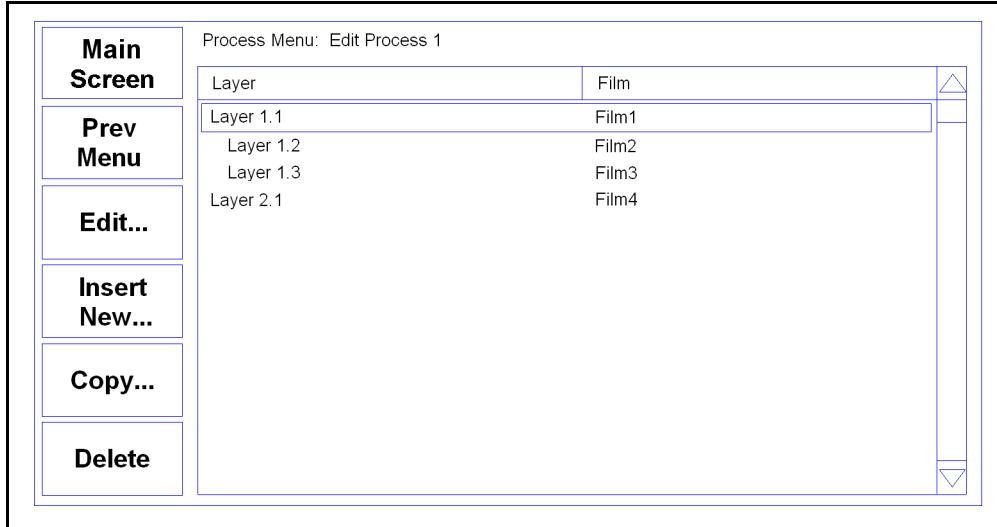

Select a layer and press **Copy** to store a copy of the layer in memory.

Figure 3-11 Copy Layer menu

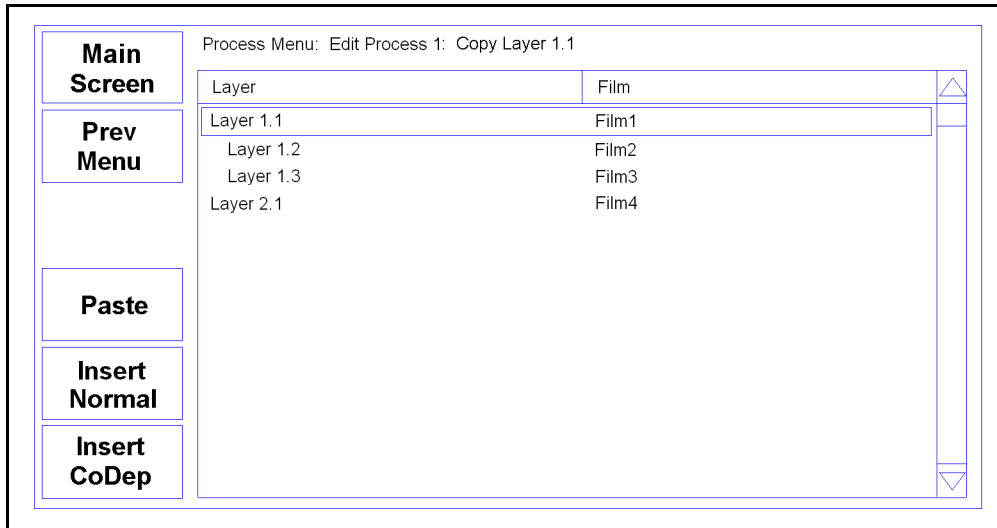

The display changes to the Copy Layer menu. The Paste, Insert Normal, or Insert CoDep button may not be visible if the operation is not allowed for the selected layer.

Paste replaces the selected layer with the layer stored in memory.



Insert Normal or Insert CoDep inserts layers above the selected layer. That is, the inserted layer will have the same number as the selected layer, and the selected layer will move down one layer.

**HINT:** When building a process it is easiest to add a test layer and insert new layers above that layer. When the process is complete, delete the test layer.

**NOTE:** Each CoDep layer (SQC-310C only) must be assigned to a different output and sensor.

A warning message is displayed if there is a conflict. Select each CoDep layer, press **Edit**, and assign unique sensors and outputs.

### 3.10 Film Menus

The Film menus allow for the entering and editing of the parameters that regulate the deposition of each film. These parameters apply any time this film is used (in any process). Rotate the control knob to scroll through and select films.

Figure 3-12 Film Select menu

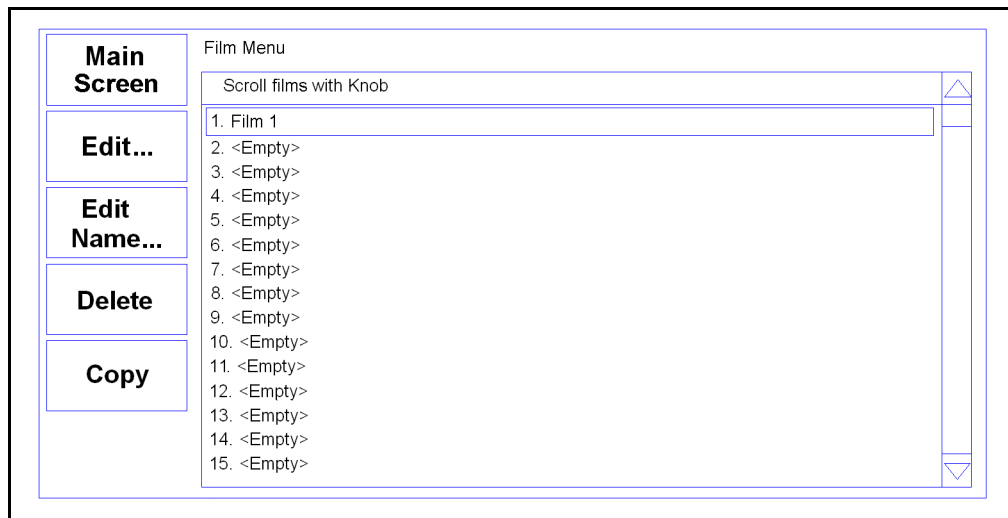

Table 3-8 Film Select menu buttons

<b>Main Screen</b>	Returns to the Main menu.
<b>Edit...</b>	Displays the Film Edit menu for the selected film.
<b>Edit Name...</b>	Displays the Character Entry screen to edit the selected film name.

Table 3-8 Film Select menu buttons (continued)

<b>Delete</b>	Deletes the selected film. <b>NOTE:</b> Films cannot be deleted if they are used in any process.
<b>Copy/Paste</b>	Copies the selected film. Scroll to a film labeled as <Empty> and press the <b>Paste</b> button to paste the copied film. The <b>Paste</b> button appears after the <b>Copy</b> button is selected.
<b>Create</b>	Available only when an undefined film (labeled as <Empty>) is selected. This button defines the empty slot as a film and assigns it a film number, allowing it to be used in a process.

Press **Edit** to display the setup parameters for the selected film.

### 3.11 Film Edit Menu

Rotate the control knob to scroll through parameters. Press the control knob to select a parameter value to edit. While parameter value is highlighted, rotate the control knob counterclockwise or clockwise to change the value. Press the control knob to save the desired change for the selected parameter.

Figure 3-13 Film Edit menu

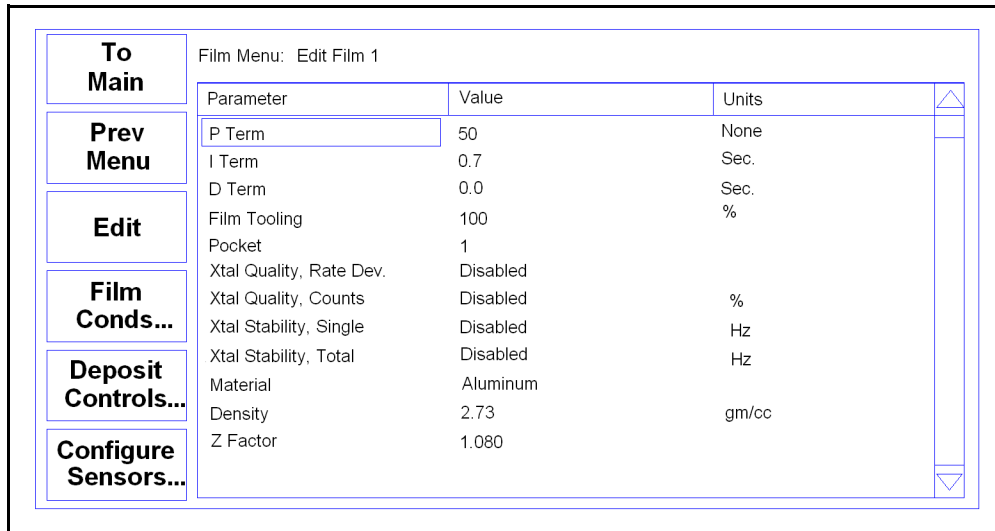

PN 074-550-P1E

Table 3-9 Film Edit menu buttons

<b>To Main</b>	Returns to the Main menu.
<b>Prev Menu</b>	Returns to the Film Select menu.
<b>Edit</b>	<p>Opens the selected parameter for edit. Button functions change to:</p> <p><b>Next:</b> Store parameter and move to next for editing.</p> <p><b>Cancel:</b> Stop editing and undo changes to selected parameter.</p> <p><b>Enter:</b> Stop editing and save values for selected parameter.</p> <p><b>Control Knob:</b> Rotate to change value. Press the control knob to store the value and move to the next parameter.</p>
<b>Film Conds...</b>	Displays pre/postconditioning settings (see <a href="#">section 3.11.1 on page 3-21</a> ).
<b>Deposit Controls...</b>	Displays deposition control settings (see <a href="#">section 3.11.2 on page 3-22</a> ).
<b>Configure Sensors...</b>	Displays crystal fail mode control settings (see <a href="#">section 3.11.3 on page 3-24</a> ).

A description of each film parameter follows:

**P Term:** The proportional term sets the gain of the control loop. High gains yield more responsive (but potentially unstable) loops. Try a value of 25, then gradually increase/decrease the value to respond to step changes in rate setpoint.

**I Term:** The integral term controls the time constant of the loop response. Try 0.5 to 1 second for e-beam systems, 5 to 10 s for thermal systems.

**D Term:** The differential term causes the loop to respond quickly to changes. Use 0 or a very small value to avoid oscillations.

**NOTE:** See [section 7.5, Control Loop, on page 7-5](#) for details on adjusting the PID control loop terms.

**Film Tooling:** Compensates for sensor sensitivity to the selected material. Use Crystal Tooling in the System menu to compensate for each sensor individually.

**Pocket:** Indicates which pocket of a multi-material indexer should be used. The source in the Sources and Sensors screen of the System Menu must be configured first (see [section 3.12.3 on page 3-36](#)).

**Crystal Quality, Rate Deviation:** The maximum allowed rate deviation, from the rolling average of the previous 16 rate readings. Each time the rate deviation exceeds the selected percent value, a counter is incremented. Each time the deviation is within the selected value, the counter decrements (to 1 minimum). Zero disables the function. If the counter reaches Crystal Quality, Counts during a layer, the process is aborted. Setting this value to zero disables the Crystal Quality alarm.

**Crystal Quality, Counts:** A counter is incremented each time Crystal Quality, Rate Deviation is exceeded, then decremented each time a reading is within the rate deviation. If the counter reaches Crystal Quality, Counts during a layer, the process is aborted. Setting this value to zero disables the Crystal Quality alarm.

**NOTE:** The Crystal Quality settings are very sensitive to PID loop tuning. It is best to leave Crystal Quality disabled until the stability of the process and PID settings are confirmed.

**Crystal Stability, Single:** As material is deposited on the crystal, the frequency normally decreases. However, arcing, mode hopping, or external stresses may cause the crystal frequency to increase. If a single large positive frequency shift exceeds this value (in Hz) during a process, a crystal fail condition is indicated.

**Crystal Stability, Total:** As material is deposited on the crystal, the frequency normally decreases. However, arcing, mode hopping, or external stresses may cause the crystal frequency to increase. If the accumulated value of these positive frequency shifts exceeds this value (in Hz) during a process, a crystal fail condition is indicated.

**Material:** Selects a material assigned to this film. As materials change, their density and Z-Ratio is updated.

**Density:** Sets the density for this material. Material density has a significant impact on deposition calculations. Common materials, densities, and Z-Ratios are listed in [Appendix A](#).

**Z-Factor:** Sets the Z-Ratio, an empirically determined measure of the effect a material has on quartz crystal frequency change. Common materials, densities, and Z-Ratios are listed in [Appendix A](#).

### 3.11.1 Film Conditioning Menu

The Film Conditioning menu contains the power settings used for preconditioning and postconditioning.

Figure 3-14 Film Conditioning menu

Film Menu: Edit Film 1: Film Conditions

Parameter	Value	Units
Ramp1 Power	25.0	%
Ramp1 Time	0:00:10	h:m m:s s
Soak1 Time	0:00:05	h:m m:s s
Ramp2 Power	50.0	%
Ramp2 Time	0:00:05	h:m m:s s
Soak2 Time	0:00:05	h:m m:s s
Feed Power	0.0	%
Ramp Time	0:00:00	h:m m:s s
Feed Time	0:00:00	h:m m:s s
Idle Power	0.0	%
Ramp Time	0:00:00	h:m m:s s

**Ramp1 Power:** Sets the power level (% of full scale) desired at the end of Ramp 1.

**Ramp1 Time:** Sets the time to ramp linearly from the initial power to Ramp 1 power.

**Soak1 Time:** Sets the time the output remains at the Ramp 1 power level.

**Ramp2 Power, Ramp2 Time, Soak2 Time:** Functions are the same as Ramp 1 and Soak 1. Typically, Ramp 2 power is set near the power level required to achieve the desired initial deposition rate.

**Feed Power:** The feed phase output power level in the postconditioning phase.

**Feed Time:** The time required to wire feed new material and the time for which the feed power will be held.

**Idle Power:** Idle power ramps output power back to zero, or holds the material at a state that is ready for deposition (usually the same as Ramp 2 power). The idle phase occurs in the postconditioning phase.

**(Idle) Ramp Time:** The time required for the power to return idle power level.

### 3.11.2 Film Deposit Controls Menu

The Deposit Controls menu contains the settings used to control shutters and controller response during error conditions (see [Figure 3-15](#)).

Figure 3-15 Deposit Controls menu

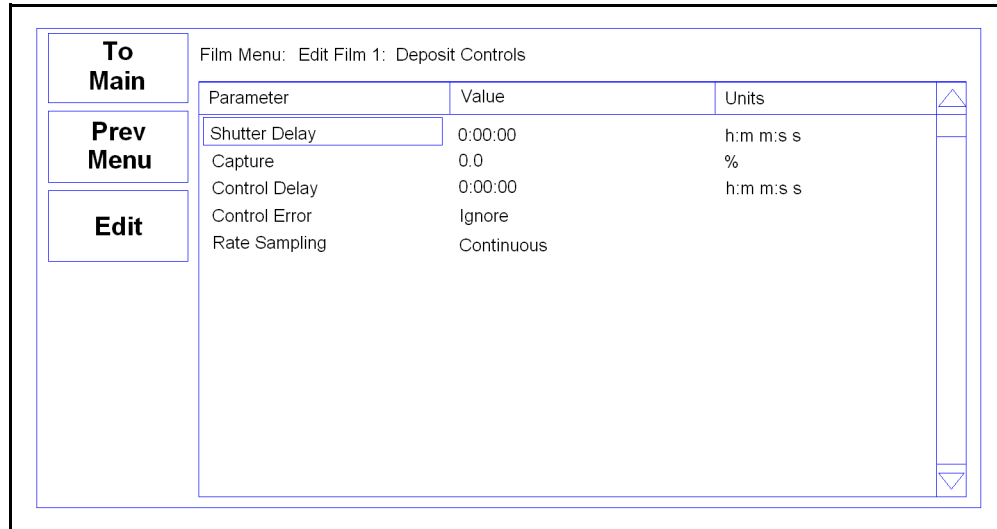

The screenshot shows a software interface titled "Film Menu: Edit Film 1: Deposit Controls". On the left side, there are three buttons: "To Main", "Prev Menu", and "Edit". The main area contains a table with the following data:

Parameter	Value	Units
Shutter Delay	0:00:00	h:m:s
Capture	0.0	%
Control Delay	0:00:00	h:m:s
Control Error	Ignore	
Rate Sampling	Continuous	

**Shutter Delay:** Used to stabilize rate control before the substrate shutter opens. Enabling shutter delay requires that the system reach a specific capture accuracy before the shutter opens. Capture is set as a percent of the Init Rate setting on the Layer Edit menu (refer to [section 3.8 on page 3-12](#)). If the rate is maintained within the Capture threshold for 5 seconds, the substrate shutter will open, thickness is cleared, and deposition will continue normally. If the rate is unable to be maintained within the threshold for 5 seconds within the Shutter Delay time, the process will halt.

**NOTE:** Shutter Delay requires the QCM sensor to be exposed to the deposition source while the substrate shutter is closed.

**Capture:** A percentage of Init Rate (refer to [section 3.8 on page 3-12](#)) that must be reached to end the shutter delay. If the capture accuracy is not reached within the shutter delay time, the process halts.

**Control Delay:** It is common to see a negative rate spike at the beginning of the Deposit state when using a source or sensor with a shutter. This is due to the sudden change in temperature that the crystal is exposed to when the shutter opens. When the Control Delay function is used, the control loop will ignore the rate for a set amount of time at the beginning of the Deposit state. This helps to eliminate overcompensation by the control loop due to rate spikes when the sensor or source shutter opens. The Control Delay setting is the amount of time SQC-310 will wait before the control loop takes over.

**Control Error:** If the control loop cannot maintain the desired deposition rate due to loss of source material, excess rate ramps, equipment malfunction, or a control error occurs, the Control Error will respond accordingly with the programmed response.

- ◆ **Ignore:** The error condition is ignored.
- ◆ **Stop:** All source outputs return to 0% power.
- ◆ **Hold:** The output power is held at the same level as when the error occurred. The process will continue to be monitored until Final Thickness is reached.
- ◆ **Error %:** Specifies the rate threshold for Control Error. Only available when Stop or Hold are selected for Control Error.

**Rate Sampling:** Rate sampling can extend the life of crystals. With rate sampling, the deposition rate is sampled for a period of time, then the sensor shutter is closed. Power is held at the same level as the final power setting during the sample period.

- ◆ **Continuous:** Disables Rate Sampling. Sensor shutter remains open during deposition.
- ◆ **Accuracy:** The sampling phase ends when the rate is maintained within the Accuracy setting percent of the Init Rate setting. The hold phase is then active for a specific time.
- ◆ **Time Based:** The sampling phase ends after a set amount of time (Sample Time). The hold phase is then active for a specific time.
- ◆ **Accuracy:** The threshold, in percent of Init Rate (refer to [section 3.8 on page 3-12](#)), which must be maintained in or order to move to the hold phase. Only available if Rate Sampling is set to Accuracy.
- ◆ **Sample Time:** The amount of time before the sampling phase ends. Only available if Rate Sampling is set to Time Based.
- ◆ **Hold Time:** The amount of time to maintain the hold phase. Used if Rate Sampling is set for either Accuracy and Time Based.

### 3.11.3 Film Configure Sensor Menu

The Configure Sensors menu contains the settings used to control crystal fail modes during error conditions (see Figure 3-16).

Figure 3-16 Configure Sensors menu

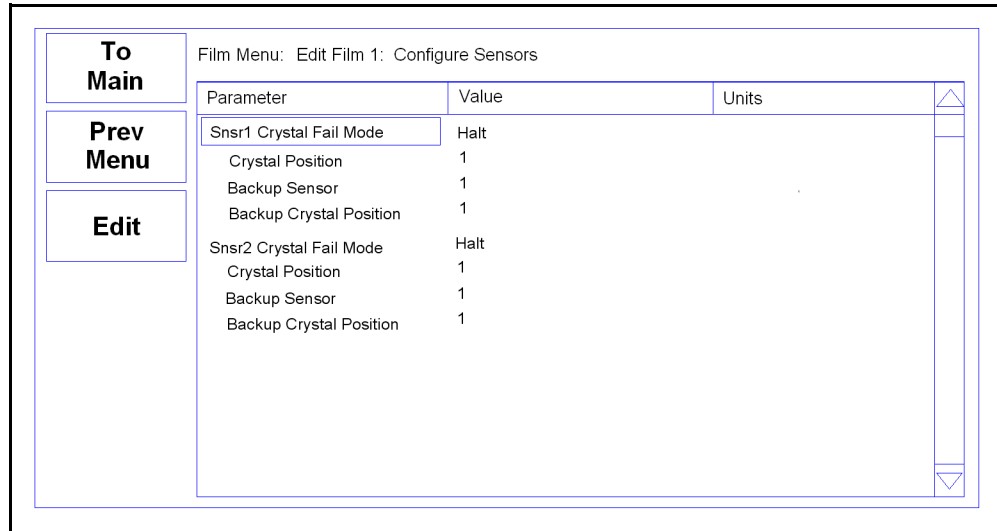

**Crystal Fail Mode:** The action that is executed if the sensor crystal fails.

**Halt:** The process will be halted in the event of a sensor failure.

**Halt Last:** The process will be halted if the last sensor of multiple assigned sensors fails.

**Timed Power:** The current layer is completed using the last power and rate readings.

**Switch to Backup:** The sensor is switched to the backup sensor in the event of a sensor failure.

**Backup:** This sensor is selected solely for use as a backup sensor. It may not be used or selected as a sensor for a film but may be used in the event of a sensor failure. Timed Power mode will be enabled if this is the last sensor to fail.

**Crystal Position:** The desired crystal position in a multi-crystal sensor head.

**Backup Sensor:** The designated sensor is to be used as a backup in the event of the main sensor failing. If a value of 2 is entered, under Sensor 1, Sensor 2 will be used as a backup when Sensor 1 fails. This will automatically set Sensor 2 Crystal Fail Mode to Backup.

**Backup Crystal Position:** The position on the backup sensor where the backup crystal is located.



### 3.12 System Menu

The System menu contains settings that affect the basic operation of SQC-310 (see Figure 3-17). System parameters generally pertain to the physical setup of the vacuum system equipment.

Figure 3-17 System Parameter menu

System Menu		Parameter	Value	Units
<b>To Main</b>		Period	.25	Seconds
<b>Edit</b>		Simulate Mode	On	On/Off
<b>Inputs...</b>		System Tooling	100	%
<b>Relays...</b>		Min Frequency	5.0e+06	Hz
<b>Logic Menu...</b>		Max Frequency	6.0e+06	Hz
<b>Sensors &amp; Sources...</b>		Dev Graph Limit	20.0	%
		Rate Filter Alpha	0.25	
		RS-232 Comm	19200	Baud
		Password Enable	Off	On/Off
		Password	1111	
		Alarm Sounds	Enabled	En/Dis
		Alert Sounds	Enabled	En/Dis
		Attention Sounds	Enabled	En/Dis

Table 3-10 System menu buttons

<b>To Main</b>	Returns to the Main menu.
<b>Edit</b>	Opens the selected parameter for edit. Button functions change to: <b>Next:</b> Store parameter and move to next for editing. <b>Cancel:</b> Stop editing and undo changes to selected parameter. <b>Enter:</b> Stop editing and save values for selected parameter. <b>Control Knob:</b> Rotate to adjust value. Press to store value and move to next parameter.
<b>Input &amp; Relays</b>	Displays menu for assigning inputs and relays.
<b>Logic Menu</b>	Displays menu for building logic statements.
<b>Sensors &amp; Sources</b>	Displays menu for identifying sensor and source types.

**Period:** Sets the measurement interval between 0.1 second (10 readings per second) and 1 second. A longer period gives higher reading accuracy, especially in low rate and low density applications.

<u>Period (seconds)</u>	<u>Frequency Resolution (Hz)</u>
0.10	0.03
0.25	0.01
0.50	0.005
0.75	0.004
1.00	0.003

**Simulate Mode:** Normal mode uses quartz crystal sensors as inputs to SQC-310 for rate and thickness readings. Simulate mode simulates the quartz crystal sensor based on the crystal frequency min/max. Simulate mode is useful for debugging process recipes but does not accurately mimic actual process control performance.

**NOTE:** Source output power must typically be 50% or more to simulate a non-zero deposition rate.

**System Tooling:** Adjusts for global deposition rates that differ from the measured substrate deposition rate (see [section 7.3 on page 7-2](#)).

**Min/Max Frequency:** The frequency values for the quartz crystal sensors used as inputs to SQC-310. The maximum frequency should be set to the frequency of a new crystal, typically 6 MHz. Sensor readings outside the minimum and maximum frequency values cause a crystal failure.

**Dev Graph Limit:** Sets the upper limit for the Rate Deviation graph Y-axis.

**Rate Filter Alpha:** Selects the amount of filtering used to display rate data. An Alpha of 1 is no filtering. An Alpha of 0.1 is heavy filtering (10 measurement rolling average).

**RS-232 Comm:** Baud rate used for RS-232 communications.

**Password Enable:** If Password is enabled, the Quick Start, Film, and System menus require a password. The Process menu can be used to select a process, but a password is required to make any changes on the Process menu.

**Password:** If Password is enabled, this parameter sets the sequence of buttons to press to enter menus. Press the desired sequence to set the password (see [Figure 3-18](#) for an illustration of the password number designations).

Figure 3-18 Password number designations



**NOTE:** Holding down buttons 1 and 6 while powering up SQC-310 sets the password to 1111.



### CAUTION

**Holding down 1, 6, and 7 (control knob) will default memory for the entire system to the factory settings. All setting will be lost.**

**Alarm Sounds:** Enables/disables the audio alarm associated with alarm conditions (most severe).

**Alert Sounds:** Enables/disables the audio alarm associated with alert conditions (less severe).

**Attention Sounds:** Enables/disables the audio alarm associated with attention conditions (least severe).

### 3.12.1 Input and Relay Menus

The Input and Relay menus of the System Parameters menu allow the operator to display and edit relays and inputs.

Inputs and relays already assigned are indicated in the Use column by Snr (Sensor), Src (Source), or LS (Logic Statement).

This menu also displays the current state of each input or relay. Items in green are currently active. Those in red are inactive.

The Relay selections have an additional button (Turn On Relay) that allows each relay to be toggled manually for testing purposes (see [Figure 3-19](#)). Relays are returned to their proper defined state on exit from this screen.



**CAUTION**

**If changes have been made to the Input or Relay menu, be sure to exit to the System menu or Main Screen before powering SQC-310 down. Otherwise, the changes may not be saved.**

Figure 3-19 Relay menu

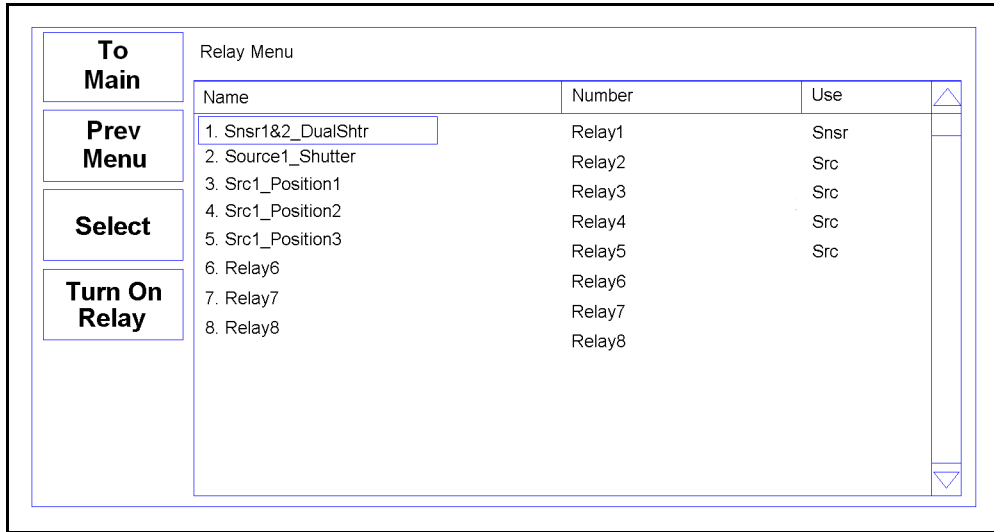
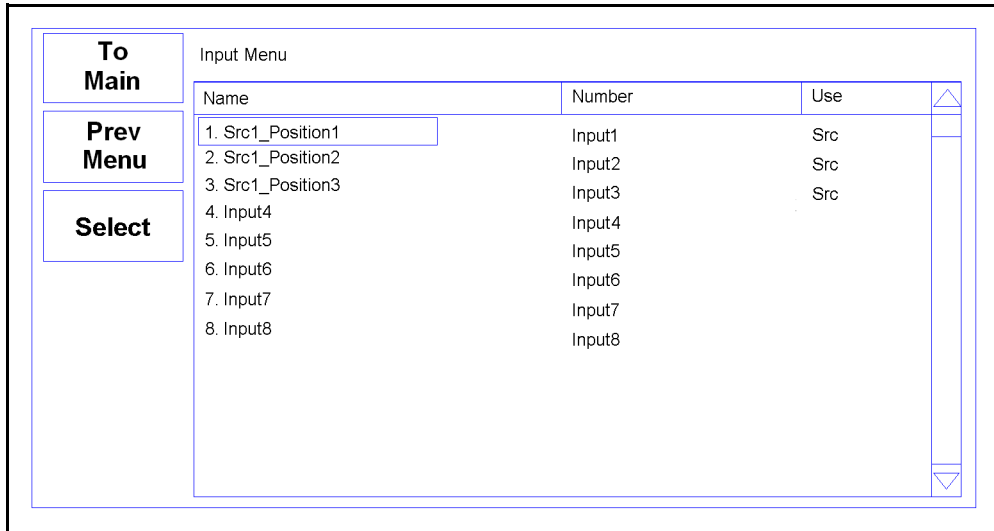

Figure 3-20 Input menu



To edit an Input or Relay, select it and press **Select**.

Editable Input parameters are:

**Name:** A logical name for this input. The system-defined default name can be returned by pressing the **Set to Default** button.

**Active Level:** The level, high (5 V) or low (0 V) that triggers the input.

**Input Number:** The physical input assigned to this logical input function. Allows for reassignment of inputs without physically rewiring any inputs or connectors.

Editable Relay parameters are:

**Name:** A logical name for this relay. The system-defined default name can be returned by pressing the **Set to Default** button.

**Type:** Normally Open (NO) contacts or Normally Closed (NC) contacts. SQC-310 uses software to implement the NO/NC function. All relays are normally open and will open when SQC-310 is turned off.

**Pulses:** Number of pulses required for activation. Setting Pulses to One Pulse will cause the relay to turn on for the Pulse Width amount of time, then turn off. Selecting None causes the relay to activate when the logical relay function is true, and deactivate when it is not. If a multi-crystal sensor is used and Control Type is set to Direct (see [section 3.12.3.1 on page 3-36](#)), this setting is read-only for any sensor drive relays.

**Pulse Width:** The time (in seconds) that the relay activates if One Pulse or Two Pulses is selected.

**Relay Number:** The physical output assigned to this logical relay function. This allows for reassignment of relays without physically rewiring any relays or connectors. Connector pins for these assignments are displayed in [Table 3-11](#).

Table 3-11 Relay and Input connector pin assignments

Relay Number	Connector Pins		Input Number	Connector Pin
Relay 1	14,15		Input 1	16
Relay 2	1,2		Input 2	17
Relay 3	3,4		Input 3	18
Relay 4	5,6		Input 4	19
Relay 5	7,8		Input 5	20
Relay 6	9,10		Input 6	21
Relay 7	11,12		Input 7	22
Relay 8	13,25		Input 8	23
			Ground	24

**NOTE:** Relays 9 to 16 and inputs 9 to 16 use the same connector pins as found on the second rear panel I/O connector (if available) in the same sequential order.

### 3.12.2 Logic Menu

Logic statements allow the programming of SQC-310 to respond to inputs and activate relays, using a variety of process conditions.

To create logic statements select **System Menu**, then **Logic Menu**. The Logic menu also displays the current state of each logic statement. Statements in green are currently true. Those is red are false.

From the list of 32 logic statement, rotate the control knob to select a statement and press **Edit** to display the Edit Logic screen (see [Figure 3-21](#)).



#### CAUTION

**If changes have been made to the Logic menu, be sure to exit to the System menu or Main Screen before powering SQC-310 down. Otherwise, the changes may not be saved.**

Figure 3-21 Edit Logic screen

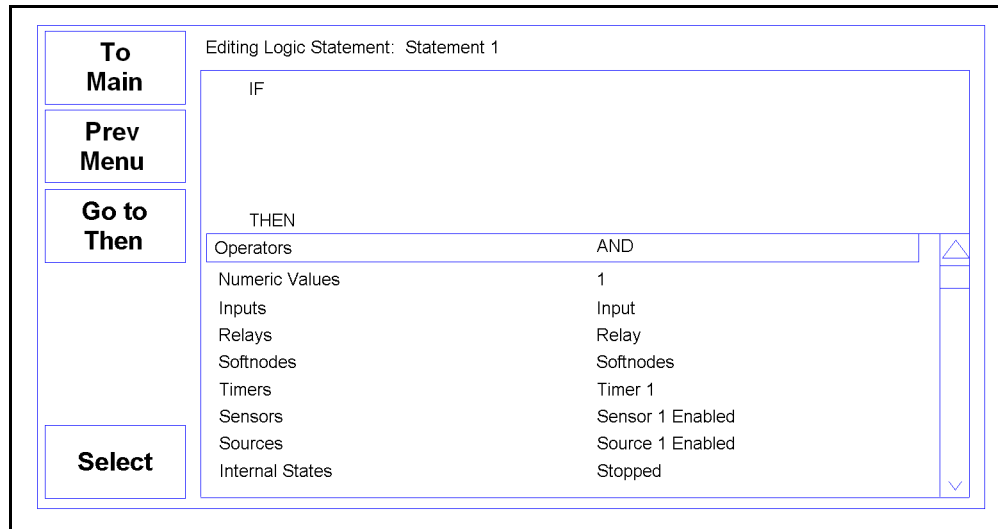

PN 074-550-P1E

Table 3-12 Edit Logic screen buttons

<b>Go to Then</b>	Moves the cursor to the THEN (action) part of the logic statement (see section 3.12.2.1 for details on creating a logic statement). This button becomes the <b>Go to Name</b> button after it is pressed.
<b>Go to Name</b>	Moves cursor to the name field. Press <b>Edit Name</b> to display the Character Input screen. This button becomes the <b>Go to If</b> button after it is pressed.
<b>Go to If</b>	Moves the cursor to the IF (condition) part of the logic statement (see section 3.12.2.1 for details on creating a logic statement). This button becomes the <b>Go to Then</b> button after it is pressed.
<b>Delete</b>	Removes last condition in the logic statement.
<b>Select</b>	Opens the selected condition for edit. Button functions change to: <b>Done:</b> Returns to regular logic menu selections. <b>Delete:</b> Removes last condition in selected logic statement. <b>Insert:</b> Adds the selected condition for current logic statement. <b>Control Knob:</b> Rotate to adjust value. Press to store value and move to next parameter.

### 3.12.2.1 Creating a Logic Statement

A logic statement consists of two parts. The first part of the statement (IF) indicates the condition that must be satisfied for the statement to become true. The second part (THEN) indicates the action that takes place once the statement becomes true.

To create a logic statement, follow the rules below. For the IF portion of the statement:

- ◆ There must be an equal number of closed and open parentheses.
- ◆ All conditions must be separated by an AND, OR, or NOT operator.
- ◆ The condition part of the logic statement cannot end in an operator.

**Enter Logic Condition:** To enter a logic condition, press **Go to If** when the IF part of the statement is not already selected. Rotate the control knob to display the condition categories, and press **Select** to display the specific conditions for that category. Select an item from the list of conditions and press **Insert** to add the condition to the IF portion of the logic statement. Press **Done** to continue building the logic statement.

To add another condition, a logic operator such as AND, OR, or NOT will be necessary. Parentheses can be used between multiple conditions but are not always necessary. Rotate the control knob to select the Operators category and press **Select**. Rotate the control knob until desired operator is selected and press **Insert**. Enter another logic condition as described above. Continue these operations until the desired IF condition is built. Up to 5 conditions can be added in this manner.

If a mistake is made, press **Delete** to delete the last entry in the IF statement.

**Enter Logic Action:** To enter a logic action, press **Go to Then** if the THEN part of the statement is not already selected. Rotate the control knob to display the action categories and press **Select** to display the specific actions for that category. Select an item from the list of actions and press **Insert** to add the action to the THEN portion of the logic statement. Press **Done** to complete the action portion of the logic statement. Only one action is possible per logic statement.

When exiting the Edit Logic Statement screen, the statement is tested for proper syntax. If there is an error, the operator is prompted to correct the error. If the error is not corrected, the logic statement will always evaluate as false.

In addition to listing the 32 logic statements, the Logic menu displays the current state of each statement. Statements in green are currently true. Those in red are false. This can be an aid for troubleshooting logic statement and digital I/O problems.

### 3.12.2.2 Logic Statement Conditions (IF)

**Operators:** For more complex logic statements, logical operators such as AND, OR, NOT, parentheses ( ), greater than >, and less than < can be added. Parentheses are used to group logic conditions, for example, IF (Input1 AND Input2) OR Input3. Every open parenthesis must have a matching closed parenthesis. The less than (<) and greater than (>) operators are used only with Timer conditions.

**Numeric Values:** Any integer between 1 and 64133. Numeric values are used with timer conditions, for example, IF Timer 1 < 100 THEN Relay1.

**Inputs:** Choose the logic state (active state) of one of the SQC-310 digital inputs as a condition. If the specified input becomes active, the logic statement will become true (choose input 1 to 16.)

**Relays:** Choose the logic state (active state) of one of the SQC-310 relays as a condition. If the specified relay becomes active, the logic statement will become true (choose relay 1 to 16).

**SoftNodes:** SoftNodes allow the building of logic statements that are based on other logic statements. There are 8 SoftNodes available for use.

For example:

```
IF (Input1 AND Input2) OR Input3 THEN SoftNode1
```

The SoftNode can then be used as a condition in another logic statement.

```
If (SoftNode1 AND CrystalFail) THEN Stop Layer
```

**Timers:** The timer condition is evaluated true whenever the timer value is greater than the value entered in the timer condition. There are 8 timers available for use.



**Sensors:** Allows the operator to choose between various sensor conditions.

Available sensor conditions include:

- Sensor Enabled (choose sensor 1 to 4)
- Sensor Shutter (choose sensor 1 to 4)
- Sensor Fail (choose sensor 1 to 4)
- All Crystals Fail
- All Crystals Good
- Dual Crystal Shutter (choose dual sensor 1 or 2)
- Sensor Timeout (choose sensor 1 to 4)

**Sources:** Allows the operator to choose between various source conditions.

Available source conditions include:

- Source Enabled (choose source 1 to 4)
- Source Shutter (choose source 1 to 4)
- Source Timeout (choose source 1 to 4)

**Internal States:** Allows the operator to choose an internal state as a condition.

Available states include:

- Stopped
- Crystal Verify
- Initialized Layer
- Manual Start Layer
- Rotate Crystal
- Rotate Pocket
- Preconditioning
- Soak Hold
- Shutter Delay
- Deposit
- Timed Power Recovery
- Crystal Switch
- Next Crystal
- Feed Ramp
- Idle Ramp
- Start Next Layer

Crystal Fail  
Stop Layer  
Sensor Feedback Timeout  
Source Feedback Timeout  
Sensor Feedback Error  
Source Feedback Error  
Invalid Crystal Position  
Invalid Pocket Position

**Internal Events:** Allows the operator to select an internal event as a condition. Available events include:

Simulate  
Manual Mode  
Interlock  
Last Layer  
Process Hold  
Process Active  
Process Stopped  
Shutter Delay Error  
Thickness Setpoint  
Final Thickness  
Time Setpoint  
Soak Hold  
Rate Dev Alarm  
Max Power Alert  
Min Power Alert

**Crystal Index:** Allows the user to select a specific crystal on a multi-crystal sensor as a condition. Choose sensor 1 to 4 and crystal 1 to 16.

**Pocket Index:** Allows the user to select a specific pocket on a multi-pocket source as a condition. Choose source 1 to 4 and pocket 1 to 16.

**Processes:** The process condition is evaluated true whenever the selected process is the current process. Choose process 1 to 100.

**Layers:** The layer condition is evaluated true whenever the current layer number equals the specified layer number. Choose layer 1 to 1000.

**Films:** The film condition is evaluated true whenever the current film number equals the specified film number. Choose film 1 to 50.

**NOTE:** References to sensor 1 to 4, source 1 to 4, relay 1 to 16, or input 1 to 16 assume SQC-310C or SQC-310 is equipped with the 4-channel option card. Units not equipped with the option card will have sensor 1 to 2, source 1 to 2, relay 1 to 8, and input 1 to 8.

### 3.12.2.3 Logic Statement Actions (THEN)

**General Actions:** A selection of actions that do not fit into another category. Available actions include:

- No Action
- Manual
- Hold in State
- Step From State
- Interlock

**Sensor & Sources:** Actions related to moving multi-crystal sensors and multi-pocket sources. Available actions include:

- Switch Crystal (choose sensor 1 to 4)
- Move Snsr to Next Position (choose sensor 1 to 4)
- Move Src to Next Pocket (choose source 1 to 4)

**Relays:** Activate one of the SQC-310 relays (choose relay 1 to 16).

**SoftNodes:** Sets a SoftNode to true (choose SoftNode 1 to 8).

**Timers:** Start a timer (choose timer 1 to 8).

**Alarms:** Activate one of the SQC-310 alarms. Alarm options include:

- Attention (least severe)
- Alert (more severe)
- Alarm (most severe)

**Process Actions:** Start or Reset current process, or select process 1 to 100.

**Layer Actions:** Perform an action on the current layer. Available actions include:

- Start Layer
- Start Next Layer
- Stop Layer
- Force Final Thickness
- Zero Thickness
- Zero Time
- Soak Hold

### 3.12.3 Sensors and Sources Menu

The Sensors and Sources menu allows the types of sensors and sources in the system to be configured, particularly multi-crystal sensors and multi-pocket sources (see Figure 3-22).

Figure 3-22 Sensor 1 Edit

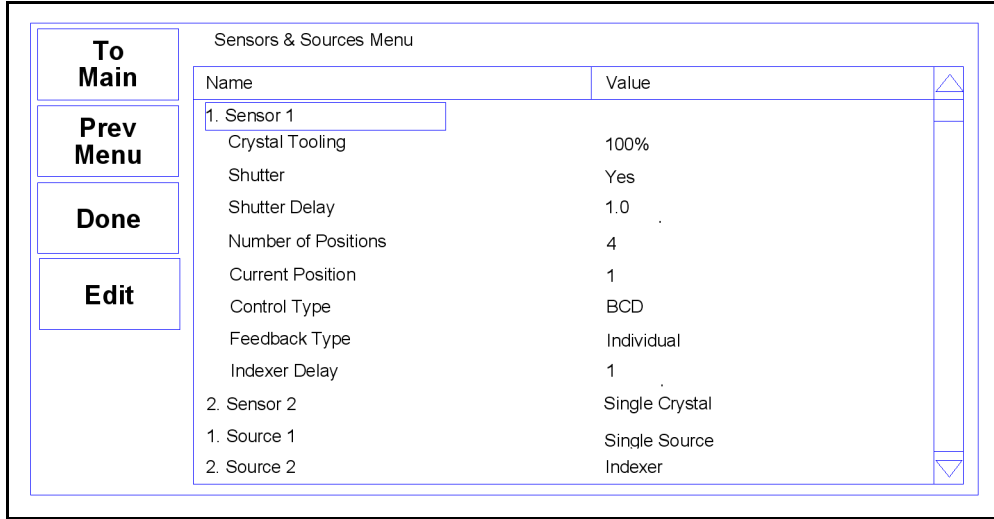

#### 3.12.3.1 Sensor Setup

**Crystal Tooling:** Adjusts for the difference in measured deposition rate between the sensor and the substrate being coated.

Figure 3-23 Crystal tooling

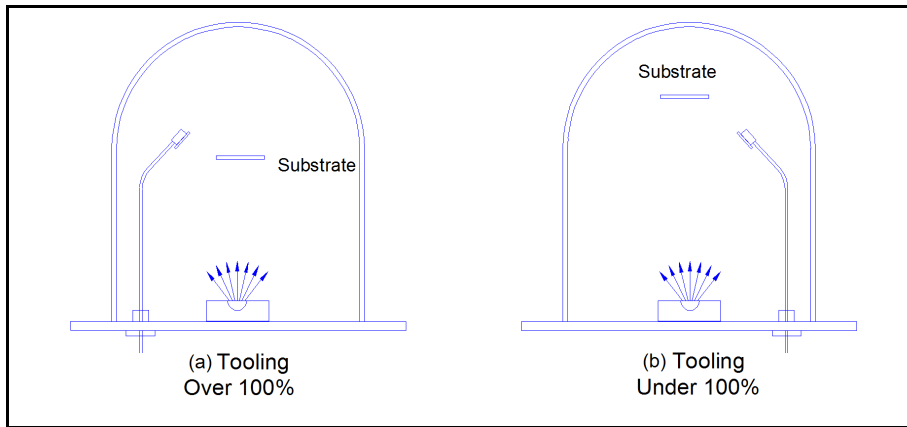

In Figure 3-23(a), the sensor will measure less rate or thickness than is actually deposited on the substrate due to the positioning of the sensor above the substrate. In Figure 3-23(b), the sensor will measure more rate of thickness than is actually deposited on the substrate due to the positioning of the sensor below the substrate.

Tooling is the ratio of the actual substrate deposition rate or thickness, to that measured by the sensor. If the rate/thickness reading is low, increase the tooling value. If the rate or thickness reading is high, decrease the tooling value.

**Shutter:** If the sensor has no shutter, select none to disable sensor shutter features. If the sensor is a typical dual sensor, with a shutter that is only activated when the primary sensor fails, select Dual. For other sensor shutters that activate when the sensor is used, select Yes.

**Shutter Delay:** If the Yes option is selected for shutter, enter the time required for the shutter to open and stabilize.

**Number of Positions:** This parameter defines the number of crystals available for that sensor input. For single head sensors, set to one. For a typical dual sensor head with separate oscillators and sensor connections, set to one because there is only one crystal for each sensor input. For a rotary type multi-crystal head, set to the number of crystals available.

**Current Position:** If a multi-crystal sensor has position feedback, this parameter is not needed. For sensors with only In Position or no position feedback, enter the current crystal position.

**Control Type:** Defines the type of crystal or pocket position control required for a multi-crystal sensor.

**Manual:** Not under control of SQC-310. With manual control, SQC-310 will stop the process upon the completion of the current layer. If the next layer requires a different crystal position, a message is displayed requesting the number of the crystals required. Once the position has been changed, press the **Continue** button.

**Direct:** Used when the actuating device is driven directly. In this case the controller creates one or two outputs, one for each available direction, to drive a motor or solenoid.

**Drive Type:** Defines the drive method or direction for Direct control.

**Up, Down, Fast, and Inline:** Select **Up** to create a single relay output used to increment the sensor to the next crystal position. **Down** works identically, except the relay output is labeled **Sensor Drive Down**. Select **Fast** to create both up and down outputs. SQC-310 will then determine the fastest direction to the target crystal position by activating the appropriate output. The Inline drive type informs SQC-310 that continuous travel in one direction is not possible. Therefore to get from position 6 to 1, the direction must be down until 1 is reached.

**Single Step and Double Step:** Used when multi-crystal sensor heads are actuated by pulsing a pneumatic value. CrystalSix rotary sensor uses Double Step. Crystal 12 and RSH-600 rotary sensors use Single Step.

**BCD:** Select when position control is through an external rotation controller which accepts Binary Coded Decimal (BCD) inputs for position selection. BCD inputs are common because they require only a few signal lines to select several positions. SQC-310 automatically creates the number of relay outputs required to interface with the external controller.

**Individual (discrete):** Select when position control requires a unique signal line for each position. SQC-310 automatically creates the number of relay outputs required to interface with the external controller.

**Feedback Type:** Defines the type of feedback for a multi-crystal sensor head. This is how the SQC-310 identifies the current crystal position.

**None:** No crystal feedback is provided. SQC-310 tracks crystal position from the current position setting (above). This setting is used for the CrystalSix and Crystal 12 rotary sensors.

**Individual (discrete):** Uses one input for each pocket position in the source. All inputs are normally false (open circuit) unless the respective pocket is in position when that input is true (closed to ground). This setting is used for the RSH-600 rotary sensor.

**BCD:** Uses binary coding to indicate the pocket position. For example, an eight-pocket source would use three inputs. With pocket one in position, all inputs would be false. With pocket four in position, inputs one and two would be true and input three would be false.

**Single Home:** This feedback indicates there is a single feedback signal that indicates when pocket one is in position.

**In Position:** The input is normally false (open circuit) and goes true (closed to ground) when any pocket is in position.

**Indexer Delay:** This parameter has two different functions. If the Feedback Type is selected as None, SQC-310 waits the designated time on the assumption that the pocket will get into position by the end of the delay. If there is position feedback, SQC-310 will wait this time for the pocket to reach the target position. If it does not receive the feedback signal, a Pocket Wait Timeout error is issued.

Table 3-13 INFICON rotary sensor settings

Sensor Type	Number of Positions	Control Type	Drive Type	Feedback Type
CrystalSix	6	Direct	Double Step	None
Crystal 12	12	Direct	Single Step	None
RSH-600	6	Direct	Single Step	Individual

### 3.12.3.2 Source Setup

Source setup parameters are identical to the sensor setup parameters (refer to [section 3.12.3.1](#)) with one exception, **Voltage Scale**.

**Voltage Scale:** Sets the maximum output voltage for the source power supply input. Voltages from -10 to +10 V are possible. Refer to the source power supply manual for the required control input voltage, typically 10 V, 5 V, -10 V, or -5 V.



---

#### CAUTION

**If changes have been made to the Logic menu, be sure to exit to the System menu or Main Screen before powering SQC-310 down. Otherwise, the changes may not be saved.**

---

---

## Chapter 4

# Communications

---

### 4.1 Introduction

SQC-310 offers the following types of data communications hardware ports:

- ◆ RS-232: 19200 to 115200 bps baud rate, 8 data bits, and no parity (standard)
- ◆ Ethernet: Port 2101, address 192.168.1.200 (optional)
- ◆ USB: PID 8292 (optional)

The RS-232 and Ethernet ports can be used simultaneously.

Both the host and server must have the same form of communications equipment and complementary setup. For serial communications, the baud rates and data word format must match.

The word format for bit serial lines (RS-232) is comprised of ten signal bits: eight data bits, one start bit, one stop bit, and no parity. The eight data bits contain a byte of information or character whose ASCII value ranges from 0 to 255.

#### 4.1.1 RS-232 Serial Port

RS-232 serial communications are accomplished through an industry standard 9-pin female connector found on the SQC-310 rear panel (refer to [Figure 2-2 on page 2-4](#)). A mating male connector is required to attach a host interface. The host and SQC-310 can be separated by up to 15.2 m (50 ft.) using a multiconductor shielded data cable.

For successful communications, the baud rate of the host computer and SQC-310 must match. Available baud rate options are: 19200, 38400, 57600, and 115200 bps.

SQC-310 is configured as DCE (Data Communication Equipment).

**NOTE:** Unpredictable RS-232 hardware/software combinations may occasionally cause a command to not be recognized by SQC-310. Consequently, all communications should include an automatic retry procedure. If a command sent using RS-232 does not produce a response from SQC-310 within three seconds, it should be sent again.



## 4.1.2 USB Port

USB drivers are provided with installation of the SQC-310 Comm software. Windows will find and install the SQC-310 USB device driver when SQC-310 is connected to a USB port.

In the event that an unsigned driver window displays during installation, click **Continue anyway**. Successful communication can be confirmed using the SQC-310 Comm software.

## 4.1.3 Ethernet (TCP/IP) Port

For Ethernet communications, SQC-310 uses the static Internet Protocol (IP) address 192.168.1.200. The optional TCP/IP interface supports only the Standard Ethernet TCP/IP protocol. SQC-310 will communicate using TCP/IP on TCP port number 2101.

The interface supports static addressing. DHCP is not supported. Ethernet parameters allow the IP address and the net mask to be set. A standard Ethernet cable is required to connect SQC-310 through a network or hub connection.

### 4.1.3.1 Ethernet Network Protocol

An IP address defines the computer on the Internet. Most computers are configured to automatically obtain the IP address from a server. Most computers will auto-configure and work with either a straight or crossover Ethernet cable.

To communicate directly with SQC-310, the IP address must be manually configured on the computer, and the computer and SQC-310 must be connected using an Ethernet cable. To manually configure the IP address:

Follow [section 4.1.3.1.1](#) for instructions to access network settings in Windows XP. Follow [section 4.1.3.1.2 on page 4-5](#) for instructions to access network settings in Windows 7 and Windows 8.

**NOTE:** The above instructions will set two values—the IP address and the Subnet mask—which may prohibit access to the Internet. If these values already contain information, make a record of the information for use in restoring the Internet connection.

**NOTE:** If the computer only has one Ethernet port (one network connection), setting the computer for direct communications will prohibit it from accessing the Internet until the setting is reversed.

SQC-310 ships with a pre-assigned address of 192.168.1.200. To communicate directly with SQC-310 from a computer, the computer must also be assigned a 192.168.1.xxx address, but *cannot* be set to 192.168.1.200. The examples in [section 4.1.3.1.1](#) and [section 4.1.3.1.2](#) use the address 192.168.1.201 for the computer. The Subnet mask 255.255.0.0 is sufficient.

**4.1.3.1.1 Accessing Network Settings in Windows XP**

- 1 Select **Network Connections** from either the Windows **Start** menu or from the **Control Panel** (see Figure 4-1).

Figure 4-1 Accessing network connections

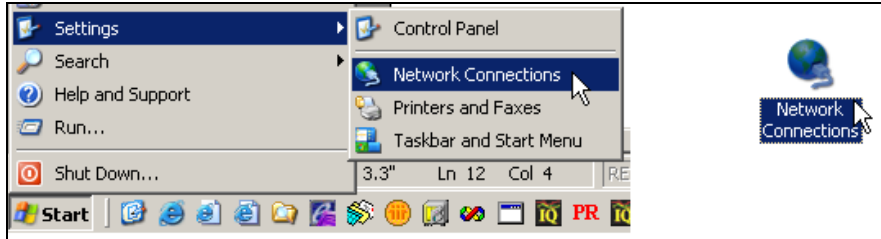

- 2 Select the **Local Area Connection** to be changed, right click and select **Properties** (see Figure 4-2).

Figure 4-2 Local Area Connection properties

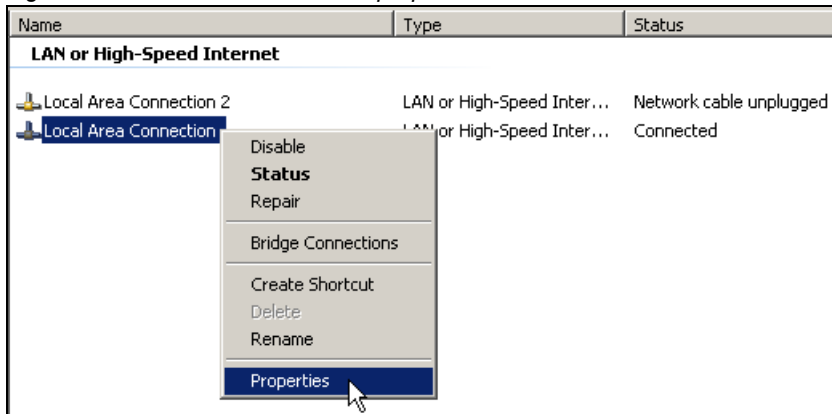

- 3 On the **General** tab, select **Internet Protocol (TCP/IP)** and click the **Properties** button (see Figure 4-3).

Figure 4-3 Internet Protocol (TCP/IP) Properties

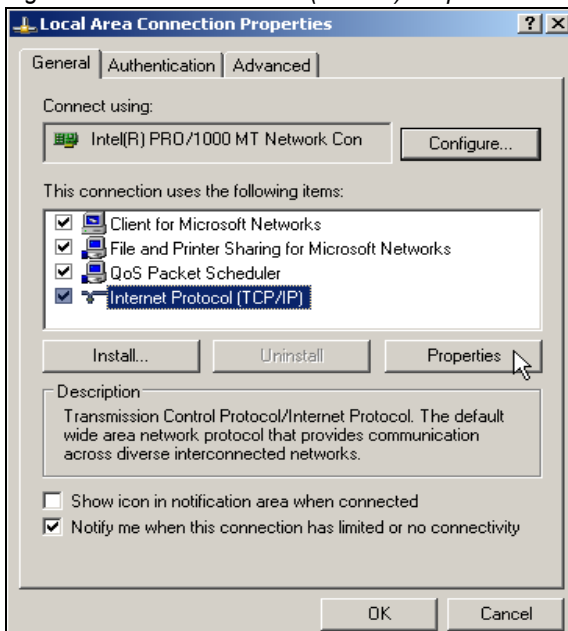

- 4 Select **Use the following IP address**, enter the **IP address** and **Subnet mask** displayed in Figure 4-4, and click **OK**. With this selection, the computer is assigned an IP address for communicating with SQC-310.

Figure 4-4 Entering the IP address and Subnet mask

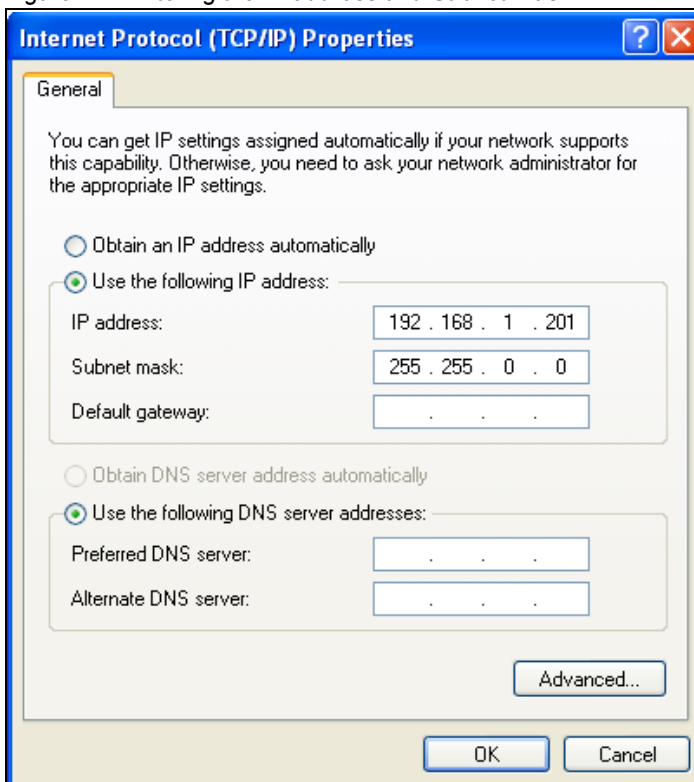

PN 074-550-P1E

- 5 Click **OK** in all open dialog boxes to close the Internet Protocol setup for the Local Area Connection. Open the SQC-310 software and confirm communications (see [section 5.7, Communications Setup Menu, on page 5-20](#)).

#### 4.1.3.1.2 Accessing Network Settings in Windows 7 and Windows 8

- 1 Open the **Control Panel** (Start >> Control Panel) and Select **Network and Sharing Center**.
- 2 Click **Change adapter settings** on the left side pane (see [Figure 4-5](#)). This will open the **Network Connections** window.

Figure 4-5 Network and Sharing Center

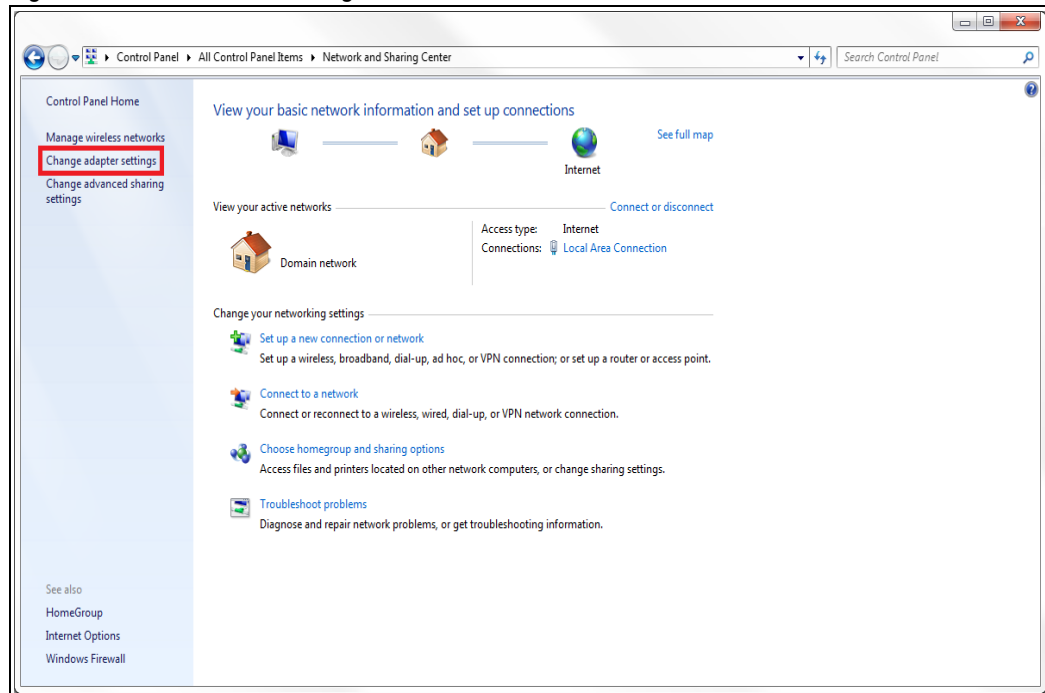

- In the **Network Connections** window, right click on the appropriate **Local Area Connection**, and select **Properties** (see Figure 4-6).

Figure 4-6 Network Connections window

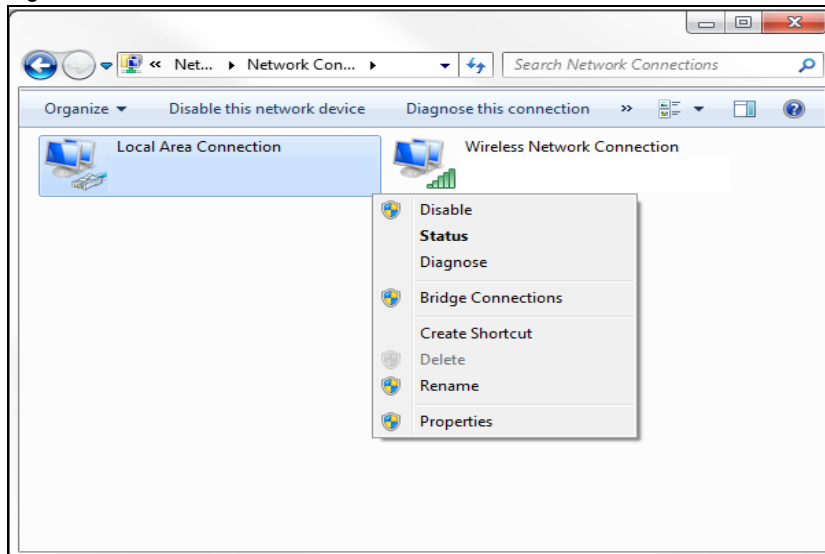

- In the **Local Area Connection Properties**, select **Internet Protocol Version 4 (TCP/IPv4)**, and click **Properties** (see Figure 4-7).

Figure 4-7 Local Area Connection properties

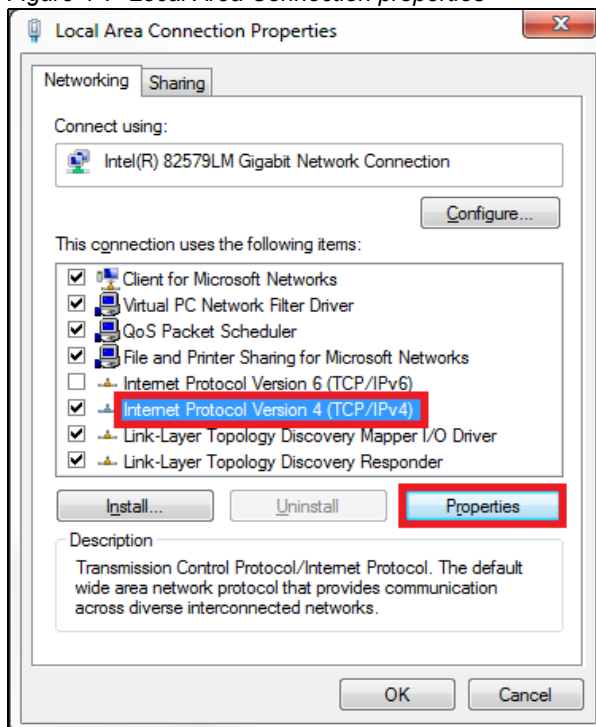

- 5 Select **Use the following IP address**, then enter the **IP address** and **Subnet mask** displayed in [Figure 4-8](#), and click **OK**. With this selection, the computer is assigned an IP address to use when communicating with SQC-310.

Figure 4-8 Entering the IP address and Subnet mask

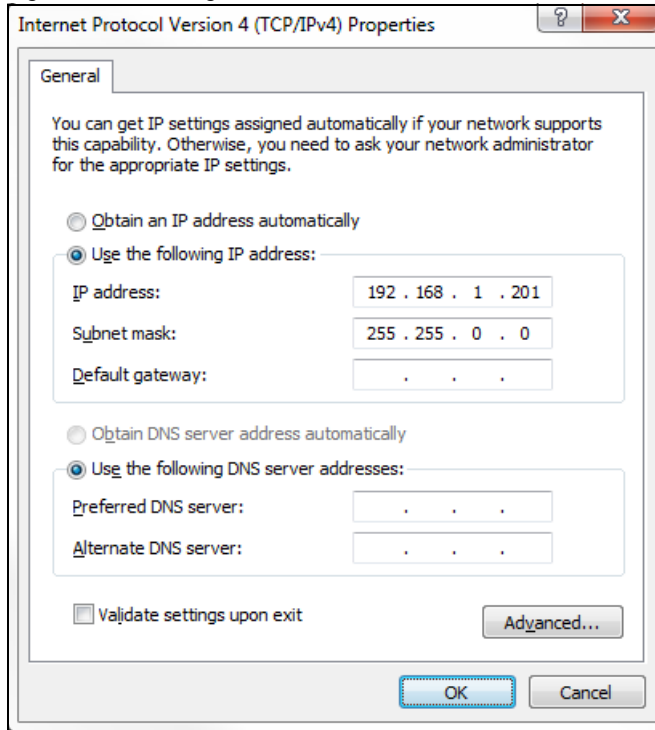

- 6 Click **OK** in all open dialog boxes to close the Internet Protocol setup for the Local Area Connection. Open the SQC-310 Comm software and confirm communications (see [section 5.7, Communications Setup Menu, on page 5-20](#)).

#### 4.1.3.2 How to change the SQC-310 IP address

The IP address can be changed using the Digi Device Discovery software (digdiscvr.exe) placed in the SQC-310 directory (typically C:/Program Files/INFICON/SQC-310 Comm) during SQC-310 Comm installation. Digi Device Discovery software can be accessed from SQC-310 Comm software by selecting Ethernet and clicking Setup in the SQC-310 Comm Setup window (see [section 5.7](#)).

To change the IP address:

- 1 Run **digdiscvr.exe** and find **SQC-310**.
- 2 Double-click on **SQC-310**.
- 3 Enter User Name: **root** and Password: **dbps**.
- 4 Click **Login**.
- 5 Click **Configuration, Network and Set**.
- 6 Change IP=192.168.1.200 to the new IP address.
- 7 Click **Apply**, then **Log Out**. The new IP address is now configured.

## 4.2 SQC-310 Communications Protocol

SQC-310 communicates with a host computer using an ASCII based protocol.

SQC-310 defaults to 19200 bps baud rate, 8 data bits, and no parity. The baud rate can be changed in the SQC-310 System menu, but is always 8 data bits with no parity.

SQC-310 only responds to commands received. It never initiates communications.

When powering up SQC-310, "abc" will be sent by the SQC-310 to the Host at the fixed baud rate of 115200. This message will not have a sync character, a length character, a status response character, or any CRC characters.

The command protocol sent to SQC-310 is:

<Sync character><Length character><1 to n Message characters><CRC1><CRC2>

The sync character is always an exclamation point (!). Following the sync character is the length character. This is the number of characters in the packet (not counting the sync, length, and CRC characters). The length character has a decimal 34 added to it so there cannot accidentally be a sync character (!) embedded in the packet.

Following the length character are the message characters as detailed in [section 4.3 on page 4-12](#). After the data are two CRC characters.

**NOTE:** Decimal points in numerical values must be removed before being sent by remote communications. For example, 12.34 would be expressed as 1234 and 45.6 would be expressed as 456.

**NOTE:** The number of parameters included in one command/response and the order of the parameters is not significant for either Set or Get messages. The format of the return string is a series of parameter numbers and commas followed by their respective values. Each set is separated by a space.

**4.2.1 Command Packet (Host to SQC-310 Message)**

<Sync character><Length character><Message><CRC1><CRC2>

**Sync** . . . . . The sync character is an exclamation point (!). Any time this character is received, the communications for that packet is reset. The sync character is not included in the CRC calculation.

**Length** . . . . . This is the decimal number of characters in the packet (excluding the sync, length, and CRC characters). This character has a decimal 34 added to it so there cannot accidentally be a sync character (!) embedded in the packet.

**Message** . . . . . Command as detailed in [section 4.3 on page 4-12](#).

**CRC** . . . . . Cyclic Redundancy Check (CRC) is a method to verify there are no errors in the packet (see [section 4.2.3 on page 4-11](#) for detailed instructions to calculate the CRC and [section 4.4 on page 4-34](#) for code examples).

**NOTE:** If CRC checking in the application is not necessary, send two Null characters (CHR\$0) for the CRC. SQC-310 will ignore the CRC. SQC-310 will still return a CRC in its response, but it can be ignored.



### 4.2.2 Response Packet (SQC-310 to Host Message)

<Sync character><Length character><Response Status character><Response Message><CRC1><CRC2>

- Sync** . . . . . The sync character is an exclamation point (!). Any time this character is received, the communications for that packet is reset. The sync character is not included in the CRC calculation.
- Length** . . . . . This is the decimal number of characters in the packet (excluding the sync, length, and CRC characters). The response length character has a decimal 35 added to it to differentiate a response from a command.
- Response Status** . . . . . This character tells the status of the sent message and is coded as displayed in [Table 4-1](#).
- Response Message** . . . . . Command Response as displayed in [section 4.3 on page 4-12](#).
- CRC** . . . . . Cyclic Redundancy Check (CRC) is a method to verify there are no errors in the packet (see [section 4.2.3](#) for detailed instructions to calculate the CRC and [section 4.4 on page 4-34](#) for code examples).

Table 4-1 Response status

Response Status	Meaning
A	Command understood, normal response
C	Invalid command
D	Problem with data in command
E	SQC-310 in wrong mode for this command
F	Invalid CRC
G	Response length exceeds 221 characters

**NOTE:** If CRC checking in the application is not necessary, send two Null characters (CHR\$0) for the CRC. SQC-310 will ignore the CRC. SQC-310 will still return a CRC in its response, but it can be ignored.

### 4.2.3 Calculating the CRC

The following algorithm is used to calculate the Cyclic Redundancy Check (CRC):

**NOTE:** The sync character and CRC are not included in the CRC calculation. All other characters should be included.

- 1 The CRC is initialized to hexadecimal 0x3FFF.
- 2 Each character in the packet is examined, bit by bit, and added to the CRC in the following manner:
  - ♦ The character is exclusive OR'd with the CRC.
  - ♦ The CRC shifts one bit position to the right.
  - ♦ If bit position 0 has a value of 1 before each shift, the CRC is exclusive OR'd with 0x2001. This is done a total of 8 times per message character.
- 3 Step 2 is repeated for each character in the message (excluding the sync character).
- 4 Mask the contents of the CRC by logical AND with 0x3FFF.
- 5 The CRC contains 14 significant bits. This is split into two pieces of 7 bits each. A decimal 34 (0x22) is added to each CRC in order to avoid there being an embedded sync character.
  - ♦ Extract bits 0 to 6 of the CRC and add a decimal 34 (0x22). This is CRC1.
  - ♦ Extract bits 7 to 13 of the CRC and add a decimal 34 (0x22). This is CRC2.

CRC code examples can be found in [section 4.4, CRC Examples, on page 4-34](#).

## 4.3 SQC-310 Commands

### 4.3.1 @ Command: Hello Message

**NOTE:** Some CRC values are non-printable characters. The examples below display all CRC values as decimal values surrounded by parentheses. Make sure to convert the decimal value in parentheses to the correct ASCII value and to remove the parentheses.

**Hello Message** = <CommandID>

**Response Message** = <String/Value>

Table 4-2 Get/Set process parameters

Cmd ID	Description	Parameters
@	Returns the model number and software version number.	None

#### 4.3.1.1 Hello Message Example

*Command: !#@ (79)(55)*

*Response: !8ASQC310D 2MB Ver 6.58(135)(124)*

or

*Response: !8ASQC310C 2MB Ver 6.58(154)(131)*

### 4.3.2 A Commands: Get/Set Film Parameters

**Get Film Command Message** = <CommandID><Space><Film Number><?><Space><Parameter>

**Get Film Response Message**= <A><Parameter><Comma><String|Value> { additional param groups} .

**Set Film Message** = <CommandID><Space><Film Number><Space><Parameter><Comma><String|Value>

**Set Film Response** = <A>

Table 4-3 Get/Set film parameters

Cmd ID	Description	Parameters	
A1	Sets/Gets the film name.	None	Film Name (16 character maximum)
A2	Sets/Gets the main film edit screen parameters.	1 2 3 4 5 6 7 8 10 11	P Term I Term <sup>1</sup> D Term <sup>1</sup> Material # Pocket (0=Pocket 1) Tooling Crystal Quality, Rate Dev % Crystal Stability, Single Freq Shift <sup>2</sup> Crystal Quality, Max Count Crystal Stability, Total +Freq Shift <sup>2</sup>
A3	Sets/Gets the film conditioning parameters.	1 2 3 4 5 6 7 8 9 10 11	Ramp1 Power <sup>1</sup> Ramp1 Time (sec.) Soak1 Time (sec.) Ramp2 Power <sup>1</sup> Ramp2 Time (sec.) Soak2 Time (sec.) Idle Power <sup>1</sup> Idle Ramp (sec.) Feed Power <sup>1</sup> Feed Ramp (sec.) Feed Time
A4	Sets/Gets the deposit controls parameters.	1 2 3 4 5 6 7 8 9	Shutter Delay (sec.) Capture Control Error (0=Ignore, 1=Stop, 2=Hold) Control Percent Rate Sampling (0=Continuous, 1=Accuracy, 2=TimeBased) Sample Accuracy Sample Hold Sample Time Control Delay
A5	Sets/Gets the sensor controls parameters.	1 2 3 4 5 6 7 8 9 10 11 12 13 14 15 16	Snsr 1 Crystal Fail Mode Snsr 1 Crystal Position Snsr 1 Backup Sensor Snsr 2 BackupXtalPosition Snsr 2 Crystal Fail Mode Snsr 2 Crystal Position Snsr 2 Backup Sensor Snsr 2 BackupXtalPosition Snsr 3 Crystal Fail Mode Snsr 3 Crystal Position Snsr 3 Backup Sensor Snsr 3 BackupXtalPosition Snsr 4 Crystal Fail Mode Snsr 4 Crystal Position Snsr 4 Backup Sensor Snsr 4 BackupXtalPosition

<sup>1</sup> Decimal point must be removed before sending the command. The response will not include the decimal point.

<sup>2</sup> Values 25 to 9999 are acceptable. Sending a 0 disables this feature.

### 4.3.2.1 Get/Set Film Parameter Examples

#### Get the Film Name of Film Number 1:

*Command:* !A1 1?(59)(75)

*Response:* !\*A Film1(152)(62)

#### Set the Film name of Film Number 1 to Film1:

*Command:* !,A1 1 Film1(45)(134)

*Response:* !\$A5(53)(151)

#### Get the PID parameters of Film Number 1:

*Command:* !-A2 1? 1 2 3(143)(117)

*Response:* !1A1,50 2,7 3,0 (83)(161)

#### Set the PID parameters of Film Number 1:

*Command:* !3A2 1 1,50 2,5 3,0(60)(96)

*Response:* !\$A(53)(151)

Invalid parameters in an A command will not trigger an error response. A good parameters before the invalid parameter will be in the response. The invalid parameter, and every parameter that follows, will be excluded from the response. For example, a command message of “A2 1? 1 X 3” will give the response message “A1,50”, skipping parameters X and 3.

### 4.3.3 B Commands: Get/Set System Parameters

**Get Command Message** = <CommandID><?><Space> <Parameter>

**Get Response Message** = <A><Parameter><Comma> <String|Value>

**Set Command Message** = <CommandID><Space><Parameter>  
<Comma><String|Value>

**Set Response Message**= <A>

Table 4-4 Get/Set system parameters

Cmd ID	Description	Parameters
B	Gets/Sets the system parameters screen values.	1 Period (centiseconds) <sup>2</sup> 2 System Tooling 5 Simulate Mode 6 Min. Frequency (Hz)(1000000 to 6500000 in increments of 100000) 7 Max. Frequency (Hz)(1000000 to 6500000 in increments of 100000) 14 Alarm Sounds 15 Alert Sounds 16 Attention Sounds 17 Rate Dev. Graph Limit <sup>1</sup> 18 Password Enabled 19 Password (XXXX containing values of 1 to 7) 20 Rate Filter Alpha Value (sec.) <sup>1</sup>
BA	Switch the graphs/displays on the main screen. <i>Message format changes to:</i> BA[Space][Parameter]	1 Display Rate vs. Time Graph 2 Display Rate Deviation vs. Time Graph 3 Display Power vs. Time Graph 4 Display Large Format Screen
BB	Turns the remote mode on or off. Remote mode ignores all local user input such as the pressing of buttons. <i>Message format changes to:</i> BB[Space][Parameter]	1 Turn Remote Mode: OFF 2 Turn Remote Mode: ON

<sup>1</sup> Decimal point must be removed before sending the command. The response will not include the decimal point.

<sup>2</sup> The Period can only be 0.10, 0.15, 0.20, 0.25, 0.30, 0.40, 0.50, 0.75, or 1.00 second(s). All invalid values round up to the next valid value. Excluding values greater than 1.00.

#### 4.3.3.1 Get/Set System Parameter Examples

##### Get the Period and System Tooling:

*Command:* !(B? 1 2(65)(117)

*Response:* !/A1,25 2,100 (81)(73)

##### Set the Period and System Tooling:

*Command:* !.B 1,25 2,100(84)(133)

*Response:* !\$A(53)(151)

##### Set the Display Rate vs. Time Graph:

*Command:* !&BA 1(81)(35)

*Response:* !\$A(53)(151)

##### Turn Remote Mode ON:

*Command:* !&BB 1(128)(160)

*Response:* !\$A(53)(151)

### 4.3.4 C Commands: Get/Set Process Parameters

**Get Command Message** = <CommandID><Process Number><?><Space><Parameter>

**Get Response Message** = <A><Parameter><Comma><String|Value>

**Set Command Message** = <CommandID><Process Number><Space><Parameter> <Comma><String|Value>

**Set Response Message** = <A>

The number of Layer Positions is the number of layer sequences in a process. The actual Layers is the total number of layers in the process. For example, a process with one CoDep layer (using two films) would have Number Layers = 1 and Actual Layers = 2.

Using the C command, the First Layer is the layer number of the first layer in the process. The next layer number in the process can be found by reading the Next Layer parameter (see [section 4.3.5](#)). If Next Layer= -1, there is no next layer.

Table 4-5 Get/Set process parameters

Cmd ID	Description	Parameters	
C	Gets/Sets the Process Name.	1	Process Name (16 characters)
C	Gets the process parameters.	2 3 4	Number of Layer Positions First Layer Number in the process Actual Layers
CA	Performs a process specific command. <i>Message format changes to:</i> CA[Process#][Space][Parameter]	1 2 3 4	Create a New Process Delete a Process Delete All Layers in this process Check this Process (1 is process is OK)
CB	Performs a process & layer location specific command. <i>Message format changes to:</i> CB[Process#][Space][LayerPosition#][Space][Parameter]	1	Cut this layer from this process
CC	Performs a process, layer location and film specific command. <i>Message format changes to:</i> CC[Process#][Space][LayerPosition#][Space][Film#][Space][Parameter]	1 2	Insert a NonCoDep layer in this process Insert a CoDep layer in this process  NOTE: Insert CoDep layer 2 parameter only valid for CoDep capable unit. For 'D' non-codep unit, will return a 2,0 code indicating insert did not work.

#### 4.3.4.1 Get/Set Process Parameter Examples

**Get Process 1 name:**

*Command:* !C1? 1(58)(90)

*Response:* !4AProcess1 (90)(42)

**Set Process 1 name:**

*Command:* !.C1 1,AnyName(135)(34)

*Response:* !\$A(53)(151)

**Create a new process:**

*Command:* !(CA1? 1(115)(124)

*Response:* !(A1,1 (58)(116)

**Cut a layer from a process:**

*Command:* !\*CB1 2? 1(151)(79)

*Response:* !(A1,1 (58)(116)

**Insert a NonCodepositon layer into a process:**

*Command:* !,CC1 2 1? 1(84)(159)

*Response:* !(A1,1 (58)(116)

An A1,1 means the command was successful.

An A1,0 means the command failed.

#### 4.3.5 D Commands and E Command: Get/Set Layer Parameters

**Get Command** = <CommandID><Layer Number><?><Space><Parameter>

**Get Response** = <A><Parameter><Comma><String|Value>

**Set Command** = <CommandID><Layer Number><Space><Parameter>  
<Comma><String|Value>

**Set Response** = <A>



Table 4-6 Get/Set layer parameters

Cmd ID	Description	Parameters
D	Gets/Sets the layer parameters for a layer number. Layer number is not the layer position number. <b>NOTE:</b> The DA command is the recommended command to Get/Set layer parameters	Same as DA Commands
DA	Gets/Sets the parameters for a given layer as specified by the given process, layer in the process, and the assigned source. <i>Message format changes to:</i> DA[Process#][Space][LayerPosition#][Space][Source#]?[Parameter]	1 Init Rate <sup>1</sup> 2 Final Thickness <sup>1</sup> 3 Time Setpoint (sec.) 4 Thickness Limit 5 Start Mode 6 Source Output Number 7 Max. Power <sup>1</sup> 8 Slew Rate <sup>1</sup> 9 Sensor 1 10 Sensor 2 11 Sensor 3 12 Sensor 4 13 Ramp1 Enable 14 Ramp1 Start (thickness) <sup>1</sup> 15 Ramp1 Rate <sup>1</sup> 16 Ramp1 Time (sec.) 17 Ramp2 Enable 18 Ramp2 Start (thickness) <sup>1</sup> 19 Ramp2 Rate <sup>1</sup> 20 Ramp2 Time (sec.) 21 Film Number 22 Next Layer Number 23 Next Codep Layer Number 24 Layer Available 25 Min. Power <sup>1</sup> 26 Power Alarm Dev. (sec.) 27 Rate Dev. Attention 28 Rate Dev. Alert 29 Rate Dev. Alarm 30 Ramp 2 Enable 31 Ramp 3 Start (thickness) <sup>1</sup> 32 Ramp 3 Rate1 33 Ramp 3 Time (sec.)
DB	Gets the layer that is currently running or set to run next if not currently running a layer. <i>Message format changes to:</i> DB?[Space][Parameter]	1 Current layer - Layer number 2 Current layer - NonCoDep Position 3 Current layer - NonCoDep Position(s) with Source Number 4 Current layer - CoDep Positions
E	Deletes all 1000 layers. Most often used to clear SQC-310 in preparation for downloading a new list.	None

<sup>1</sup> Decimal point must be removed before sending the command. The response will not include the decimal point.

#### 4.3.5.1 Get/Set Layer Parameter Examples

**NOTE:** The recommended command to Get/Set layer parameters is the DA command. The D command relies on the layer number, which may not be sequential in a process. The DA command Gets/Sets layer parameters for the layer in a unique process, position, and source.

**Get Process 1, Layer 1, Source 1 initial rate and final thickness:**

*Command:* !.DA1 1 1? 1 2(90)(89)

*Response:* !,A1,0 2,0 (86)(133)

**Get layer status information:**

*Command:* !-DB? 1 2 3 4(40)(67)

*Response:* !FA1,4:4:4 2,1 3,1.1:1.1:1.1 4,1:1:1 (154)(60)

**Delete all layers:**

*Command:* !#E(143)(54)

*Response:* !\$A(53)(151)

### 4.3.6 F Command: Get/Set Material Parameters

Only one material may be Get/Set at a time.

**Get Command** = <CommandID><Material Number><?><Space><Parameter>

**Get Response** = <A><String|Value>

**Set Command** = <CommandID><Material Number><Space><Parameter>  
<Comma><String|Value>

**Set Response** = <A>

Table 4-7 Get/Set material parameters

Cmd ID	Description	Parameters
F	Gets/Sets the parameters of the 100 stored materials.	1 Material Name (16 character maximum) 2 Density <sup>1</sup> 3 Z-Factor (Z-Ratio) <sup>1</sup>

<sup>1</sup> Decimal point must be removed before sending the command. The response will not include the decimal point.

#### 4.3.6.1 Get/Set Material Parameter Examples

**Get Material 1 name:**

*Command:* !F1? 1(135)(105)

*Response:* !,AAluminum(57)(152)

**Set Material 1 name:**

*Command:* !/F1 1,Aluminum(99)(39)

*Response:* !\$A(53)(151)

### 4.3.7 G Commands: Get/Set Input and Relay Parameters

**Get Command** = <CommandID><Input#|Relay#><?><Space> <Parameter>

**Get Response** = <A><Parameter><Comma> <String|Value>

**Set Command** = <CommandID><Input#|Relay#><Space><Parameter><Comma> <String|Value>

**Set Response** = <A>

Table 4-8 Get/Set input and relay parameters

Cmd ID	Description	Parameters
GA	Gets/Sets the parameters of each of the 8 or 16 digital inputs. When changing the name (parameter 1), the Name Mode command (parameter 5) must be set to 1 as the next parameter.	1 Name (16 character maximum) <sup>1</sup>
		2 Active Level (0= Low, 1= High)
		3 Pin Number
		4 Input in Use (get only)(1=True, 0=False)
		5 Name Mode (0= Default, 1= User)
GB	Gets/Sets the parameters of each of the 8 or 16 digital relays. When changing the name (parameter 1), the Name Mode command (parameter 5) must be sent to 1 as the next parameter.	1 Name
		2 Type (0=N.O, 1=N.C)
		3 Pulses (0 to 2)
		4 Pulse Width (ms) <sup>2</sup>
		5 Pin Number
		6 Relay in Use (get only)(1=True, 0= False)
		7 Name Mode (0= Default, 1= User)
GC	Gets the current state of each of the 8 or 16 digital inputs and/or relays.	1 Current Relay State (off=0, on=1)
		2 Current Input State (off=0, on=1)
GD	Permanently override the relay state for one of the 8 or 16 digital relays. Overriding the relay is only available while in the stopped state. The override is removed at the start of a process.  <i>Message format changes to:</i> GD[Relay#][Space][Parameter]	1 Override Relay: Turn On
		2 Override Relay: Turn Off
GE	Allows an unused relay to be set remotely. Relays set remotely aren't effected by logic statement actions, sensors, sources, or the GD command. Be sure to unlock the relay after it is no longer needed, doing so will also turn the relay off.  <i>Message format changes to:</i> GE[Relay#][Space][Parameter]	1 Turn Relay On (locks Relay for remote use only)
		2 Turn Relay Off (locks Relay for remote use only)
		3 Unlock Relay (Releases the relay back to SQC-310 control)

<sup>1</sup> Do not exceed 16 characters for the name. Doing so may yield negative results.

<sup>2</sup> Values from 500 to 3000 in increments of 100.

#### 4.3.7.1 Get/Set Input and Relay Parameter Examples

**Get the active level and pin number for input 1:**

*Command: !\*GA1? 2 3(112)(143)*

*Response: !,A2,0 3,1 (90)(108)*

**Get the type and pin number for relay 1:**

*Command: !\*GB1? 2 5(121)(129)*

*Response: !,A2,0 5,1 (105)(135)*

**Get the current input 1 and relay 1 state:**

*Command: !)GC1?1 2(58)(97)*

*Response: !(A2,0 (58)(124)*

**Override relay 1:**

*Command: !'GD1 1(107)(46)*

*Response: !\$A(53)(151)*

**Lock relay 1 in the on position:**

*Command: !'GE1 1(132)(99)*

*Response: !\$A(53)(151)*

Once locked in either the on or off position, the relay can only be controlled using remote communications.

### 4.3.8 H Commands: Get/Set Sensor and Source Parameters

**Get Command** = <CommandID><Sensor|Source><?><Space><Parameter>

**Get Response** = <A><String|Value>

**Set Command** = <CommandID><Sensor|Source><Space><Parameter>  
<Comma><String|Value>

**Set Response** = <A>

Table 4-9 Get/Set sensor and source parameters

Cmd ID	Description	Parameters
HA	Gets/Sets the parameters of each of the 2 or 4 sensors.	1 Crystal Tooling
		2 Number of Positions
		3 Shutter (0=No, 1=Dual, 2=Yes)
		4 Shutter Delay (ms)(0 to 9900 in increments of 100)
		5 Control Type (0=Manual, 1=Direct, 2=BCD, 4=Individual)
		6 Drive Type (0=Up, 1=Down, 2=Fast, 3=Inline, 4=Single Step, 5=Double Step)
		7 Feedback Type (0=None, 1=Individual, 2=BCD, 3=Single Home, 5=In Position)
		8 Indexer Delay (sec.)
		9 Current Crystal Position
HB	Gets/Sets the parameters of each of the 2 or 4 sources.	1 Voltage Scale <sup>1</sup>
		2 Number of Positions
		3 Shutter (0=No, 2=Yes)
		4 Shutter Delay (ms)(0 to 9900 in increments of 100)
		5 Control Type (0=Manual, 1=Direct, 2=BCD, 4=Individual)
		6 Drive Type (0=Up, 1=Down, 2=Fast, 3=Inline, 4=Single Step, 5=Double Step)
		7 Feedback Type (0=None, 1=Individual, 2=BCD, 3=Single Home, 4=In Position)
		8 Indexer Delay (sec.)
		9 Current Pocket Position
HC	Gets the status flags for each of the 2 or 4 sensors.	1 Dual crystal has switched
		2 Backup crystal switch has begun
		3 Backup crystal switch is done
		4 Sensor is disabled
		5 Original crystal has failed
		6 Sensor is currently in use
		7 Next crystal move complete
		8 Sensor initiated time power
		9 Sensor initiate halted

Table 4-9 Get/Set sensor and source parameters (continued)

Cmd ID	Description	Parameters	
HD	Gets the status flags for each of the 2 or 4 sources.	1	Source is currently in use (0= not in use, 1= in use)
HE	Gets/Sets the I/O mappings of each of the 2 or 4 sensors.	1 2	Input Map Relay Map
HF	Gets/Sets the I/O mappings of each of the 2 or 4 sources.	1 2	Input Map Relay Map

<sup>1</sup> Decimal point must be removed before sending the command. The response will not include the decimal point.

#### 4.3.8.1 Get/Set Sensor and Source Parameter Examples

**Get sensor 1 number of positions, control type, and current crystal position:**

Command: !,HA1? 2 5 9(153)(140)

Response: !0A2,1 5,1 9,1 (67)(113)

**Get source 1 number of positions, control type, and current pocket position:**

Command: !,HB1? 2 5 9(77)(83)

Response: !0A2,1 5,3 9,1 (142)(52)

**Get status flags (original crystal fail and in use) for sensor 1:**

Command: !\*HC1? 5 6(50)(112)

Response: !,A5,0 6,0 (101)(149)

**Get status flags (in use) for source 1:**

Command: !(HD1? 1(86)(130)

Response: !(A1,1 (58)(116)

**Get I/O mapping of sensor 1:**

Command: !\*HE1? 1 2(63)(37)

Response:

!hA1,0:0:0:0:0:0:0:0:0:0:0:0 2,0:0:0:0:0:0:0:0:0:0:0:0:0 (91)(147)

**Get I/O mapping of source 1:**

Command: !\*HF1? 1 2(38)(82)

Response:

!iA1,0:0:0:0:0:0:0:0:0:0:0:0 2,21:1:0:0:0:0:0:0:0:0:0:0:0 (155)(98)

### 4.3.9 I Commands: Get/Set Logic Statement Parameters

**Get Command** = <CommandID><Logic Statement#><?><Space> <Parameter>

**Get Response** = <A><String|Value>

**Set Command** = <CommandID><Logic Statement#><Space><Parameter>  
<Comma><String|Value>

**Set Response** = <A>

Table 4-10 Get/Set logic statement parameters

Cmd ID	Description	Parameters
I	Gets/Sets the parameters of each of the 32 logic statements.	1 Name (16 characters) 2 If Conditions (up to 16 conditions) 3 Then Action 4 If Condition Syntax Valid (get only) 5 If Condition Current State (get only) 6 LS Defined (0= not defined, 1= defined)
IA	Copy and Pastes a Logic Statement from one index to another. <i>Message format changes to:</i> IA[Space][Statement# to Copy][Space][Statement# to Paste]	None
IB	Deletes a Logic Statement. <i>Message format changes to:</i> IB[Statement# to Delete]	None

#### 4.3.9.1 Get/Set Logic Statement Parameter Examples

**Get Statement 1 name, If condition, and Then action:**

*Command:* !+I1? 1 2 3(43)(78)

*Response:* !?A1,<Empty> 2,0 3,0 (161)(135)

**Set Statement 1 name, If condition, and Then action:**

*Command:* !I1 1,LS\_1 2,202:3:201 3,302(59)(155)

*Response:* !\$A(53)(151)

**Copy and paste a logic statement:**

*Command:* !(IA 1 5(83)(100)

*Response:* !\$A(53)(151)

**Delete a logic statement:**

*Command:* !%IB1(40)(93)

*Response:* !\$A(53)(151)



### 4.3.10 J Command: Get Num Channels

**Get Command Message** = <CommandID>

**Get Response Message** = <A><String|Value>

Table 4-11 Get Num channels parameters

Cmd ID	Description	Parameters
J	Returns the number sensor/output channels installed.	None

#### 4.3.10.1 Get Num Channels Examples

**Get the number of sensors/sources:**

Command: !#J(79)(56)

Response: !%A4(119)(61)

4 sensors/sources channels are installed.

### 4.3.11 K Command: Get Readings

**Get Command Message** = <CommandID><Parameter>

**Get Response Message** = <A><String|Value>

Table 4-12 Get readings parameters

Cmd ID	Description	Parameters
K	Returns the phase time and sensor or output readings for all installed channels.	1 Output Readings 2 Sensor Readings
K3	Same as K2 but will respond with an error if there are no new sensor readings since the last time the command was sent. Used primarily for the testing SQC-310.	None

**4.3.11.1 Get Readings Examples**

**Get Output readings:**

*Command: !\$K1(93)(49)*

*Response: !cA0.00 0.00 100.00 0.000 0.00 -1 -1 -1 -1 -1 -1 -1 -1 -1 -1 -1(44)(90)*

The return string is of the form: Time, Rate 1, Deviation 1, Thickness 1, Power 1, Rate 2, Deviation 2, Thickness 2, etc.

**Get Sensor readings:**

*Command: !\$K2(157)(49)*

*Response: ! 80A0.00 0.00 0.000 5950000.00 0.00 0.000 5950000.00 0.00 0.000 5950000.00 0.00 0.000 5950000.00(80)(85)*

The return string is of the form: Time, Rate 1, Thickness 1, Frequency 1, Rate 2, Thickness 2, etc.

**4.3.12 L Command: Get Sensor Rate**

**Get Command Message** = <CommandID><Sensor Number>

**Get Response Message** = <A><String|Value>

*Table 4-13 Get sensor rate parameters*

Cmd ID	Description	Parameters
L	Returns the sensor rate for the requested sensor. Uses the density and z-ratio of the last material used if no active layer is currently assigned.	Sensor Number (1 to 4)

**4.3.12.1 Get Sensor Rate Example**

**Get sensor 1 rate:**

*Command: !\$L1(102)(50)*

*Response: !)A 0.00(87)(100)*

**4.3.13 M Command: Get Output Rate**

**Get Command Message** = <CommandID><Output Number>

**Get Response Message** = <A><String|Value>

*Table 4-14 Get output rate parameters*

Cmd ID	Description	Parameters
M	Returns the average rate of all sensors assigned to the requested output.	Output Number (1 to 4)

**4.3.13.1 Get Output Rate Example**

**Get output 1 rate:**

*Command: !\$M1(92)(113)*

*Response: !)A 0.00(87)(100)*

**4.3.14 N Command: Get Sensor Thickness**

**Get Command Message** = <CommandID><Sensor Number>

**Get Response Message** = <A><String|Value>

*Table 4-15 Get sensor thickness parameters*

Cmd ID	Description	Parameters
N	Returns the thickness reading for the requested sensor. Uses the density and z-ratio of the last material used if no active layer is currently assigned.	Sensor Number (1 to 4)

**4.3.14.1 Get Sensor Thickness Example**

**Get Sensor 1 thickness:**

*Command: !\$N1(93)(81)*

*Response: !\*A 0.000(90)(92)*

**4.3.15 O Command: Get Output Thickness**

**Command Message** = <CommandID><Output Number>

**Response Message** = <A><String|Value>

*Table 4-16 Get output thickness parameters*

Cmd ID	Description	Parameters
O	Returns the average thickness of all sensors assigned to the requested output.	Output Number (1 to 4)

**4.3.15.1 Get Output Thickness Example**

**Get Output 1 thickness:**

*Command: !\$O1(103)(146)*

*Response: !\*A 0.000(90)(92)*

### 4.3.16 P Commands: Get Sensor Frequency/Crystal Life

**Get Command Message** = <CommandID><Sensor Number>

**Get Response Message** = <A><String|Value>

Table 4-17 Get sensor frequency/crystal life parameters

Cmd ID	Description	Parameters
P	Returns the frequency of the requested sensor.	Sensor Number (1 to 4)
PA	Returns the status, frequency, and crystal life of the requested sensor.	Sensor Number (1 to 4)

#### 4.3.16.1 Get Sensor Frequency/Crystal Life Example

**Get Sensor 1 frequency:**

*Command:* !\$P1(90)(145)

*Response:* !.A5950000.00(93)(84)

**Get Sensor 1 information:**

*Command:* !%PA1(74)(147)

*Response:* !6A0 5950000.00 95.00(70)(99)

The return string is of the form: Status (where status 0=inactive, 1=active), Frequency, and Crystal Life

### 4.3.17 Q Command: Get Output Deviation

**Get Command Message** = <CommandID><Output Number>

**Get Response Message** = <A><String|Value>

Table 4-18 Get output deviation parameters

Cmd ID	Description	Parameters
Q	Returns the % deviation of the requested output.	Output Number (1 to 4)

#### 4.3.17.1 Get Output Deviation Example

**Get Output 1 deviation:**

*Command:* !\$Q1(104)(82)

*Response:* !+A100.00(67)(127)

### 4.3.18 S Command: Get/Set Output Power

**Get Command Message** = <CommandID><?><Space><Output Number>

**Get Response Message** = <A><String|Value>

**Set Command Message** = <CommandID><Output Number><Space><String|Value>

**Set Response Message** = <A>

Table 4-19 Get/Set output power parameters

Cmd ID	Description	Parameters
S	Gets the output power for output 1 to 4. Sets outputs to PID loop mode (parameter 0). Sets to Manual mode (parameters 1 to 4) and sets the output power for the specified output. All other outputs lock into their last used PID loop power when set to Manual mode.	0 PID loop mode all outputs(set only) 1 Output 1 <sup>1</sup> 2 Output 2 <sup>1</sup> 3 Output 3 <sup>1</sup> 4 Output 4 <sup>1</sup>

<sup>1</sup> Decimal point must be dropped before sending the command. The response will not include the decimal point.

#### 4.3.18.1 Get/Set Output Power Examples

**Get Output 2 power:**

*Command:* !&S? 2(48)(135))

*Response:* !)A0.00 (97)(136)

**Set Manual mode and set Output 2 to 50.0% of full scale:**

*Command:* !(S2 500(54)(63)

*Response:* !\$A(53)(151)

This command places other outputs in Manual mode at their current power as well.

**Set PID loop mode:**

*Command:* !\$S0(154)(146)

*Response:* !\$A(53)(151)

### 4.3.19 T Command: Set Active Process

**Set Command Message** = <CommandID><Process Number>

**Get Response Message** = <A><String|Value>

Table 4-20 Set active process parameters

Cmd ID	Description	Parameters
T	Gets/sets the currently selected process. If a process is running, it is not changed and a D response status is returned.	Process Number (1 to 100)

#### 4.3.19.1 Set Active Process Example

**Set the active process to Process 1:**

*Command:* !\$T1(104)(50)

*Response:* !\$A(53)(151)

### 4.3.20 U Commands: Set Run State

**Set Command Message** = <CommandID><Parameter>

**Set Response Message** = <A>

Table 4-21 Set run state parameters

Cmd ID	Description	Parameters
U	Sets SQC-310 operating state	0 Start Process
		1 Stop/Reset Process
		2 Start Layer
		3 Stop Layer
		4 Next Layer
		5 Force Final Thickness
		32 Zero Thickness
		33 Zero Time
		38 Soak Hold Enable
		39 Soak Hold Disable

#### 4.3.20.1 Set Run State Example

**Start the Active process:**

*Command:* !\$U0(155)(82)

*Response:* !\$A(53)(151)

### 4.3.21 V Commands: Get Run State

**Get Command Message** = <CommandID><?><Parameter>

**Get Response Message** = <A><Parameter><Comma><String|Value>

Table 4-22 Get run state parameters

Cmd ID	Description	Phase #
V	Returns the Phase #, Process Elapsed Time in seconds (displayed on SQC-310 main screen as H:MM:SS), Process #, Active Layer number of the active process, and Manual/Automatic control (0=Manual, 1=Automatic).	0 Stopped
		1 Crystal Verify
		2 Initialize Layer
		3 Manual Start Layer
		4 Crystal Rotate
		5 Pocket Rotate
		6 PreCond (CoDep only)
		7 Ramp 1
		8 Soak 1
		9 Ramp 2
		10 Soak 2
		11 Soak Hold
		12 Shutter Delay
		13 Deposit
		14 Rate Ramp
		16 Timed Power
		17 Rate Sample Thermal Delay
		18 Rate Sample
		19 Crystal Switch
		20 Feed Ramp
		21 Feed Soak
		22 Idle Ramp
		24 Crystal Fail
		25 Stop Layer
		26 Manual Power
		27 Snsr Feedback Timeout
		28 Src Feedback Timeout

Table 4-22 Get run state parameters (continued)

Cmd ID	Description	Phase #
VA	Gets the on/off status of each possible alarm (0=Off, 1=On).	1 Alarm: Min. Rate and Max. Power
		2 Alarm: Max. Rate and Min. Power
		3 Alarm: Shutter Delay Error
		4 Alarm: Crystal Failure
		5 Alarm: Source Timeout
		6 Alarm: Sensor Timeout
		7 Alarm: No Sensors Enabled
		8 Alarm: In Time Power
		9 Alarm: Rate Deviation
		10 Alarm: Invalid Pocket
		11 Alarm: Invalid Crystal
		12 Alarm: Logic Statement Action
		13 Alert: Rate Deviation
		14 Alert: Max. Power
		15 Alert: Rate Deviation
		16 Alert: Max. Power
		17 Alert: Min. Power
		18 Alert: Logic Statement Action
		19 Attention: Crystal Failure
		20 Attention: Crystal Failed and Switched
		21 Attention: Rate Deviation
		22 Attention: Max. Power
		23 Attention: Min. Power
		24 Attention: Manually Move Source to Position
		25 Attention: Manually Move Sensor to Position
		26 Attention: Interlock via Logic Statement Action
		27 Attention: Logic Statement Action

**4.3.21.1 Get Run State Examples**

**Get Run State:**

Command: !#V(78)(142)

Response: !-A0 0 1 1 1(95)(138)

The return string for the Deposit Phase, Elapsed Time =15 seconds, Active Process #1, Layer #2, Automatic Control is: 13 15 1 2 1

**Get Alarm/Alert/Attention State:**

Command: !+VA? 1 2 3(79)(145)

Response: !0A1,0 2,0 3,0 (130)(77)



### 4.3.22 XSTART / XSTOP Command: Download/Upload Session

**Command Message** = <CommandID>

**Response Message** = <A>

The recommended command instead of XSTART or XSTOP is BB1 or BB2 respectively.

Table 4-23 Start/Stop download/upload session parameters

Cmd ID	Description	Parameters
XSTART	Starts a upload/download session and places in SQC-310 in remote mode. Prevents the CA, CB, CC, and U commands from being accepted by SQC-310 (error E). SQC-310 must be Stopped in order to start an upload/download session.	None
XSTOP	Stops an upload/download session and exits remote mode.	None

#### 4.3.22.1 Start/Stop Download/Upload Session Example

**Start a download/upload session:**

*Command:* !(XSTART(127)(46)

*Response:* !\$A(53)(151)

**Stop a download/upload session:**

*Command:* !XSTOP(35)(38)

*Response:* !\$A(53)(151)

## 4.4 CRC Examples

This section includes examples of code for calculating the CRC in Visual Basic, Java, and C++. Instructions for calculating the CRC are located in [section 4.2.3 on page 4-11](#).

#### 4.4.1 Visual Basic® 5/6

```
Public Sub CalcChkSumByte(ByRef ByData() As Byte, ByRef byCRC() As Byte)
```

```

    Dim CRC As Integer
    Dim TmpCRC As Integer
    Dim LastIndex As Long
    Dim i As Integer
    Dim j As Integer

    LastIndex = UBound(ByData())

    ' Avoid on length messages
    If ByData(1) > 0 Then
        ' Set 14 bit CRC to all ones
        CRC = &H3FFF
        For j = 1 To LastIndex - 2
            ' XOR current character with CRC
            CRC = CRC Xor ByData(j)
            ' Go thru lower 8 bits of CRC
            For i = 1 To 8
                ' Save CRC before shift
                TmpCRC = CRC
                ' Shift right one bit
                CRC = Shri(CRC, 1)
                If (TmpCRC And 1) = 1 Then
                    ' If LSB is 0 (before shift), XOR with hex 2001
                    CRC = CRC Xor &H2001
                End If
            Next i
        Next j
        ' Be sure we still have 14 bits
        CRC = CRC And &H3FFF
        byCRC(0) = (LoByte(CRC) And &H7F) + 34
        byCRC(1) = (LoByte(Shri(CRC, 7)) And &H7F) + 34
    Else
        ' Empty message
        byCRC(0) = 0
        byCRC(1) = 0
    End If
End Sub

```

```
End Sub
```

```
Public Function LoByte(ByVal intNumber As Integer) As Byte
```

```

    ' Comments : Returns the low byte of the passed integer
    ' Parameters: intNumber - integer value for which to return the low byte
    ' Returns : byte
    ' Source : Total VB SourceBook 6

```

```
'
  On Error GoTo PROC_ERR
```

```
  LoByte = intNumber And &HFF&
```

```
PROC_EXIT:
  Exit Function
```

```
PROC_ERR:
  MsgBox "Error: " & Err.Number & ". " & Err.Description, , _
    "LoByte"
  Resume PROC_EXIT
```

```
End Function
```

```
Public Function Shri( _
  ByVal lngValue As Long, _
  ByVal bytPlaces As Byte) _
  As Integer
  ' Comments : Shifts a long Value right the selected number of places
  ' Parameters: lngValue - integer Value to shift
  '           bytPlaces - number of places to shift
  ' Returns : Shifted value
  ' Source : Total VB SourceBook 6
  '
```

```
  Dim lngDivisor As Long
```

```
  On Error GoTo PROC_ERR
```

```
  ' if we are shifting 16 or more bits, then the result is always zero
```

```
  If bytPlaces >= 16 Then
```

```
    Shri = 0
```

```
  Else
```

```
    lngDivisor = 2 ^ bytPlaces
```

```
    Shri = Int(IntToLong(lngValue) / lngDivisor)
```

```
  End If
```

```
PROC_EXIT:
  Exit Function
```

```
PROC_ERR:
  MsgBox "Error: " & Err.Number & ". " & Err.Description, , _
    "Shri"
  Resume PROC_EXIT
```

```
End Function
```

#### 4.4.2 Java®

```
private short calcCRC(byte[] str) {
    short crc = 0;
    short tmpCRC;
    int length = 1 + str[1] - 34;
    if (length > 0) {

        crc = (short) 0x3fff;
        for (int jx = 1; jx <= length; jx++) {
            crc = (short) (crc ^ (short) str[jx]);

            for (int ix = 0; ix < 8; ix++) {
                tmpCRC = crc;
                crc = (short) (crc >> 1);
                if ((tmpCRC & 0x1) == 1) {
                    crc = (short) (crc ^ 0x2001);
                }
            }
            crc = (short) (crc & 0x3fff);
        }
    }
    return crc;
}

private byte crcHigh(short crc) {
    byte val = (byte) (((crc >> 7) & 0x7f) + 34);
    return val;
}

private byte crcLow(short crc) {
    byte val = (byte) ((crc & 0x7f) + 34);
    return val;
}
```

### 4.4.3 C++

```
class CRC14
{
public:
CRC14(void) { crc = 0x0;};

public:
short crc;

public:
short calcCRC( unsigned char * str)
{
int length = (str != NULL) ? 1 + str[1] - 34 : 0;

if (length > 0) {

    crc = (short) 0x3fff;
    for (int jx = 1; jx <= length; jx++) {
        crc = (short) (crc ^ (short) str[jx]);

        for (int ix = 0; ix < 8; ix++) {
            short tmpCRC = crc;
            crc = (short) (crc >> 1);
            if ((tmpCRC & 0x1) == 1) {
                crc = (short) (crc ^ 0x2001);
            }
        }
        crc = (short) (crc & 0x3fff);
    }
    return crc;
}
unsigned char crc2() {
    unsigned char val = (unsigned char) (((crc >> 7) & 0x7f) + 34);
    return val;
}
unsigned char crc1() {
    unsigned char val = (unsigned char) ((crc & 0x7f) + 34);
    return val;
}
};
```

## Chapter 5

# SQC-310 Comm Software

### 5.1 Introduction

SQC-310 Comm software provides real-time control and process data logging. It also allows process, layer, film, and material parameters to be programmed and downloaded to SQC-310 or saved as a \*.mdb file.

SQC-310 controllers with firmware Version 5.01 and earlier are not compatible with SQC-310 Comm software. For these older units, use SQC-300 Comm software (Version 4.xx). This manual may not be compatible with older software versions. Contact INFICON for more information (refer to [section 1.3 on page 1-5](#)).

SQC-310 Comm software offers the ability to:

- ◆ Operate the process remotely.
- ◆ Display SQC-310 readings in both numerical and graphical format.
- ◆ Data log and store SQC-310 readings to a text file on a drive.
- ◆ Create and store an unlimited number of processes, layers, and films.
- ◆ Download and upload configuration files to SQC-310.

Refer to [Chapter 4, Communications](#) for information on connecting to SQC-310 and to view communications commands.

### 5.2 Installation

To install SQC-310 Comm software:

- 1 Insert the Thin Film Instrument and Sensor Manuals CD (PN 074-5000-G1).

**NOTE:** If installation does not start automatically, click **Start**, then **Run**, then type <d>:UtilityDisk (where <d> is the drive in use). The Program Disk menu should appear. On the Program Disk menu, click **SQC310 and SQC310C Deposition Controller**, then click SQC-310 Comm Software. Follow the directions given.

- 2 When installation is complete, restart the computer (if prompted to do so).
- 3 To start SQC-310 Comm software, click the **SQC-310 Comm** desktop icon, or click **Start >> Programs >> INFICON**, then **SQC-310 Comm**. The SQC-310 Comm software Main window will be displayed.

### 5.3 Main Window

Figure 5-1 SQC-310 Comm Main window

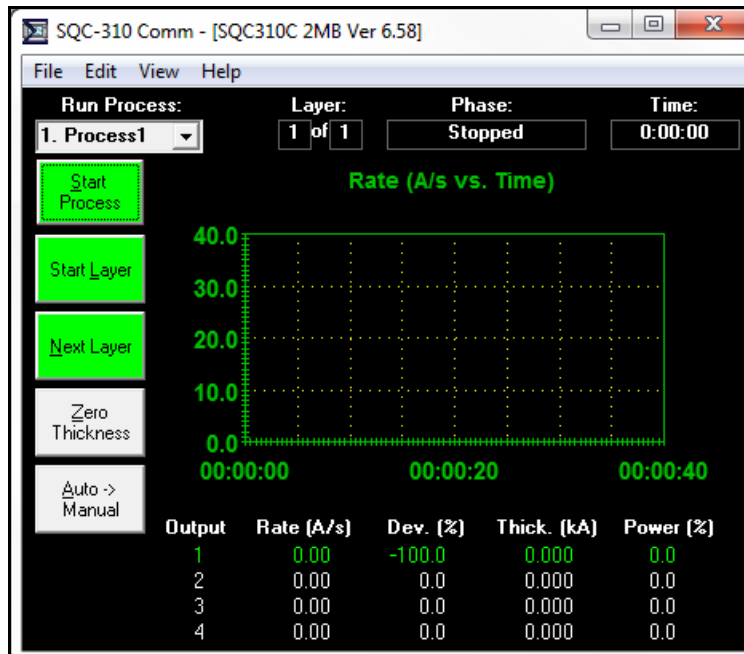

The Main window allows for operation and displays live readings and process information. Its appearance and uses are identical to that of the Main screen on SQC-310.

On SQC-310 Comm software startup, it may take a few seconds to display the Main window and read SQC-310 setup information. Once the setup information is read, the screen will change to match the current setup on SQC-310.

If the Communications Setup window is displayed, no SQC-310 was found on the expected communications port. Follow the instructions in [Chapter 4, Communications](#) to establish communications. The top tool bar and SQC-310 firmware version number are only visible if communications has been established with a connected SQC-310. Otherwise, an SQC-310 Offline status message is displayed in the window title bar.

The Main window menus allow for the configuration of the SQC-310 Comm software and the connected SQC-310. Some menu selections are not available during data acquisition or if SQC-310 communications are not established. The Main window control functions are listed below.

**Run Process** . . . . . Selects the active process on SQC-310. Defaults on SQC-310 Comm software startup to the first SQC-310 process.

**Layer** . . . . . Displays the active layer and total number of layers in the active process.

- Phase** . . . . . Displays the phase of the process that is currently running. A typical sequence of phases is: Ramp 1, Soak 1, Ramp 2, Soak 2, Shutter Delay, Deposit, and Idle power.
- Time** . . . . . Displays the elapsed time since the process was started.
- Start/Reset Process** . . . . . Start/Stop the active process. Graphing and data logging will begin/end when this button is clicked. This button will also reset the process time.
- Start/Stop Layer** . . . . . Start/Stop the active layer. Graphing and data logging will begin/end when this button is clicked. This button will also reset the process time.
- Next Layer** . . . . . Moves to the next layer of the process. If the current layer is the last layer, wraps to layer 1.
- Start Man Layer** . . . . . Manually starts the active layer.
- Zero Thickness** . . . . . Zeroes the average and sensor thickness reading on SQC-310.
- Auto->Manual** . . . . . Allows for the power outputs to be controlled manually or automatically using a PID loop. Can be set before the **Start** button is pressed or during the process. A slider bar will appear next to each output and the power can be adjusted for any active outputs. The maximum power setting will determine the maximum range of the scale for the slider bar.
- Graph** . . . . . Displays readings from SQC-310. A graph of the average rate, rate deviation, or output power can be selected on the Main screen View menu.

Below the graph are readings from each of the SQC-310 deposition control loops. The readings are arranged by outputs. If multiple sensors are assigned to a single output, the readings will be the average of the assigned sensors.

- Rate** . . . . . The current rate of deposition ( $\text{\AA}/\text{s}$ ), based on the average of all sensors assigned to the output.
- Deviation** . . . . . The deviation of the output rate from the rate setpoint (%).



- Thickness** . . . . . The current film thickness, based on the average of all sensors assigned to the output (kÅ).
- Power**. . . . . The current film thickness, based on the average of all sensors assigned to the output (%).

### 5.4 Data Log Menu

On the Main window toolbar, click **File >> Data Log** to display the Data Log menu which configures the data logging functions (see Figure 5-2).

Figure 5-2 Data log menu

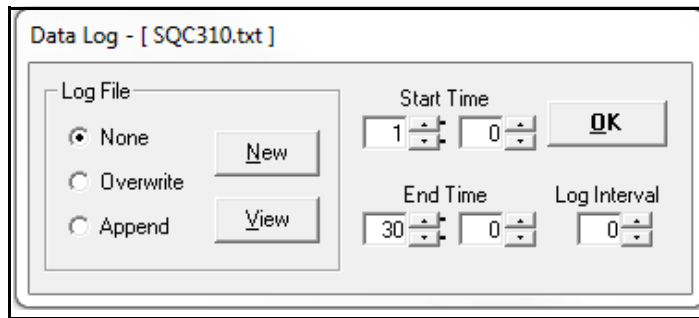

Data is saved in a comma delimited format for easy viewing or importing into a spreadsheet. For example:

```
Start: Date: 6/27/2014 Time: 8:32:27
Time,Phase,Out1Rate,Out1Dev,Out1Thk.....Sens1Rate,Sens1Thk,Sens1Freq.....
0.1, Shutter Delay, 0.00,100.0,0.000.....Sensors:, 0.00,0.000,5950000.000.....
0.5, Deposit, 0.00,100.0,0.000.....Sensors:, 0.00,0.000,5950000.000.....
0.8, Deposit, 0.00,-100.0,0.000.....Sensors:, 0.00,0.000,5950000.000.....
1.4, Deposit, 0.00,-100.0,0.000.....Sensors:, 0.00,0.000,5950000.000.....
2.0, Deposit, 0.00,-100.0,0.000.....Sensors:, 0.00,0.000,5950000.000.....
2.7, Deposit, 0.00,-100.0,0.000.....Sensors:, 0.00,0.000,5950000.000.....
3.3, Deposit, 0.00,-100.0,0.000.....Sensors:, 0.00,0.000,5950000.000.....
3.9, Deposit, 0.00,-100.0,0.000.....Sensors:, 0.00,0.000,5950000.000.....
4.5, Deposit, 0.00,-100.0,0.000.....Sensors:, 0.00,0.000,5950000.000.....
5.2, Deposit, 0.00,-100.0,0.000.....Sensors:, 0.00,0.000,5950000.000.....
End: Date: 6/27/2014 Time: 8:32:32
```

Controls on the Data Log window are:

- None** . . . . . Data is not logged.
- Overwrite** . . . . . The log file will be overwritten each time data logging is started with the **Start Process** or **Start Layer** button on the Main window.
- Append** . . . . . Data is added to the end of the log file each time data logging is started with the **Start Process** or **Start Layer** button on the Main window.
- New** . . . . . Displays a file open dialog box, to allow selection or creation of a new log file.
- View** . . . . . Displays the current log file using the default Windows text file viewer.
- Start Time** . . . . . The elapsed time when data logging begins. The right value is seconds and the left value is minutes.
- End Time** . . . . . The elapsed time when data logging ends. The right value is seconds and the left value is minutes.
- Log Interval** . . . . . The elapsed time between data log entries, in seconds. Data will be logged as quickly as possible when an interval value of zero is entered. This time will vary with system configuration.

Once communications have been established, follow these steps to start data acquisition:

- 1** Select the desired process/layer from the list of SQC-310 processes/layers.
- 2** Press **Zero** to zero the thickness reading (optional).
- 3** With the log file option set to append or overwrite, Press **Start Process** or **Start Layer** to start data acquisition.

## 5.5 Instrument Window

The Instrument window is used to edit processes, films, materials, and other SQC-310 setup data. In the Main window toolbar, click **Edit >> Instrument...** to display the Instrument window. When **Edit >> Instrument** is selected in the Main window toolbar, the configuration from SQC-310 is downloaded if communications have been successfully established (refer to [Chapter 4, Communications](#)). The Read Instrument window will be displayed with a status bar for the upload progress.

Figure 5-3 Read Instrument window

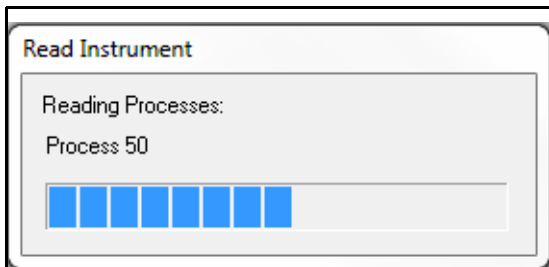

Once the configuration is loaded or an existing database is opened, the Instrument window will be displayed and the name of the configuration will replace [Instrument Upload] in the window title bar.

Figure 5-4 Instrument window

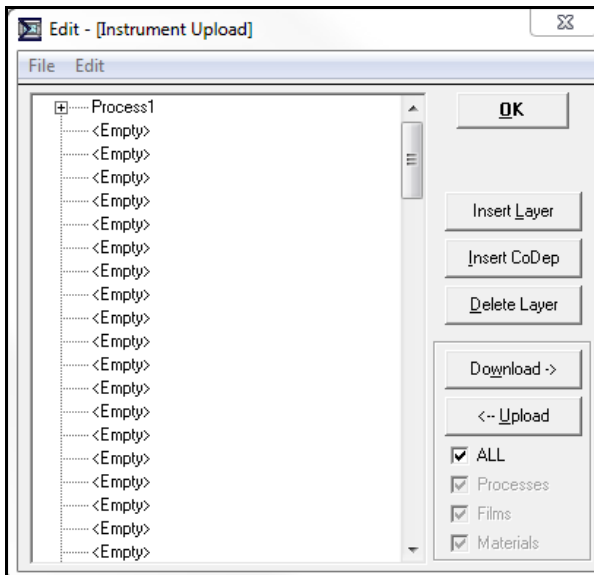

**NOTE:** It is important to keep in mind that data edited here is only held in memory, it is not automatically saved or downloaded. Click **File >> Save Database** or **Save As Database** to save the data in memory to a \*.mdb file or Select the ALL checkbox and click **Download->** to send any configuration (database) changes to SQC-310.

On the Instrument window toolbar, click **File** to display the options to open an existing database, save the current database file, or save the current database with a different name.

Interface options between SQC-310 and SQC-310 Comm software are shown in this window.

- OK** ..... Closes the SQC-310 Instrument window. If data is still in memory, but it has not been saved to a disk, a prompt warning that changes have not been saved will be displayed.
- Download->** ..... Click to download data from the SQC-310 Comm software to SQC-310. The existing SQC-310 data will be overwritten.
- <-Upload** ..... Click to upload data from SQC-310 to the SQC-310 Comm software. The existing SQC-310 Comm software data will be overwritten.
- All** ..... Select to download/upload processes, layers, films, materials, and the additional system setups (Sensors, Sources, Logic, Inputs, and Relays). Clear to unlock individual download/upload options.
- Processes** ..... Select to download/upload only processes and layers. The films and materials will remain as defined on SQC-310 (for downloads) or in memory (for uploads).
- Films** ..... Select to download/upload all films. Click **Edit >> Films...** to display or edit films. The processes and materials will remain as defined on SQC-310 (for downloads) or in memory (for uploads).
- Materials** ..... Select to download/upload all materials. Click **Edit >> Materials...** to display or edit materials. The processes and films will remain as defined on SQC-310 (for downloads) or in memory (for uploads).

### 5.5.1 Process Tree

The Process Tree is displayed in the Instrument window. It can be used to build processes, add, delete, and edit layers. It is an indented outline (tree view) of the processes in the current configuration. To name a process, click on an **<Empty>** process to open the process name editing window. Processes can be renamed but they cannot be deleted. Process names can be 16 characters long. SQC-310 always holds a list of 100 processes, even if some are empty. After naming the process, the buttons on the Instrument window can be used to add layers to the process. If a process with layers requires editing click the + symbol beside the process to display the individual layers and films that comprise the process (see Figure 5-5).

Figure 5-5 Process Tree - adding layers

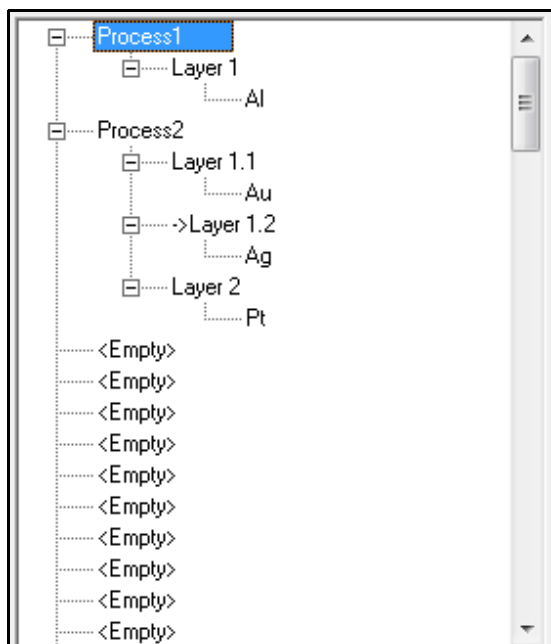

The three buttons used to interface with the Process Tree are:

**Insert Layer** . . . . . To insert a layer, click **Insert Layer** button, then select the process to which the layer will be added.

**Insert CoDep** . . . . . To insert a Codeposition layer, click **Insert CoDep** button, then select the layer in process with which the new layer will be simultaneously deposited. Codeposition processes will only run on SQC-310C.

**Delete Layer** . . . . . Click **Delete Layer** first, then click an existing layer to delete it.

**NOTE:** This action cannot be undone.

### 5.5.2 Film Menu

In the Instrument window toolbar, click **Edit >> Films...** to display the Film Edit window to assign materials stored in the database to films (50 films maximum) which are used to define process layers (see [Figure 5-6](#)). Alternatively, on the Process Tree, click the **+** next to a process name to display the layers for that process. Click the **+** next to a layer name to display the film for that layer. Double-click the film to open the Film menu.

**NOTE:** Any changes to a film will apply to every layer, in every process where that film is used.

Figure 5-6 Film menu

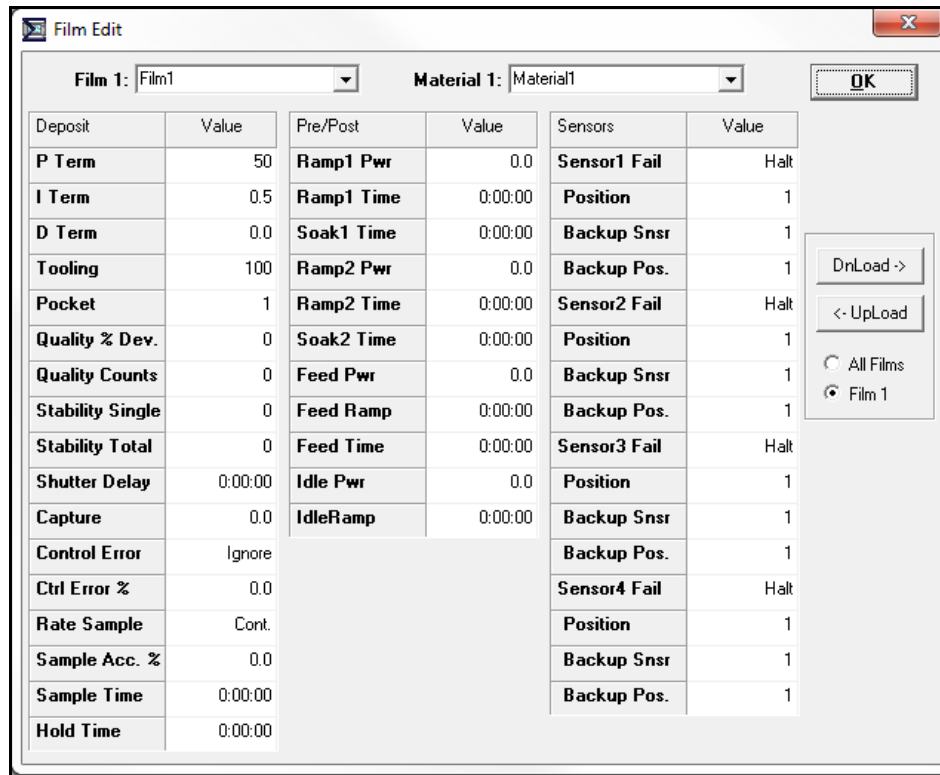

**Film** . . . . . Selects the film to be edited. Click on the film dropdown box to edit the film name.

**Material** . . . . . List of available database materials. The material displayed/selected is designated for the film currently displayed.

For complete list of parameters, definitions, usage, and the range of acceptable values for each parameter refer to [section 3.11, Film Edit Menu, on page 3-18](#).

**OK** . . . . . Closes the Film menu and saves the data to memory. Be sure to select **File >> Save Database** or **Save As Database** to save any changes to the database (.mdb) file.

- Download->** . . . . . Click to download materials from the SQC-310 Comm software to SQC-310. The existing SQC-310 data will be overwritten.
- <-Upload** . . . . . Click to upload materials from SQC-310 to the SQC-310 Comm software. The existing SQC-310 Comm software data will be overwritten.

Click the **All Films** button to download/upload all films or the **Film #** button to download/upload a specific film.

### 5.5.3 Materials Menu

In the Instrument window toolbar, click **Edit >> Materials...** to edit the 100 materials stored in the database (see [Figure 5-7](#)).

Figure 5-7 Materials menu

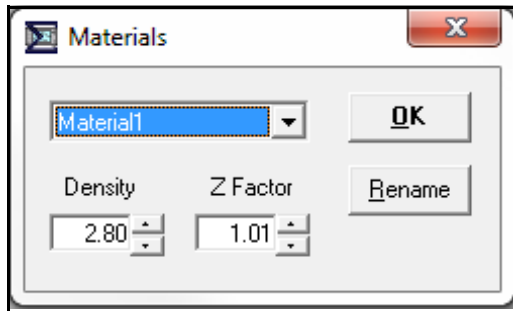

- OK** . . . . . Closes the Materials menu and saves the data to memory.
- Material** . . . . . Lists the existing materials in the database. Selecting another material will change the current material and allow editing of material parameters.
- Density** . . . . . Density of the selected material. Values from 0.50 to 99.99 g/cm<sup>3</sup> are valid.
- Z-Factor** . . . . . Z-Ratio of the selected material. Values from 0.100 to 9.999 are valid.
- Rename** . . . . . Changes the name of a database material. To add a material, select one of the materials that is not being used and rename it to the desired material. Change the Density and Z-Ratio accordingly.

See [Material Table on page A-1](#) for known density and Z-Ratio (Z-Factor) values.

**NOTE:** Any changes to a material will apply to every layer, in every process where that film/material is used.

### 5.5.4 Sensor Setup Menu

In the Instrument window toolbar, click **Edit >> Sensors...** to display the Sensors Setup menu and edit the parameters of sensors that are connected to each SQC-310 sensor input. Four sensors are displayed but SQC-310 may only have two sensor inputs (see [Figure 5-8](#)).

**NOTE:** Sensor setup is closely linked to Digital I/O definitions. Changing a sensor may cause SQC-310 to alter its internal I/O definitions. For this reason, the software must be connected to SQC-310. Click **Download** to verify and modify SQC-310 configuration before selecting **OK** to close the Sensor Setup menu and save the data to memory.

Figure 5-8 Sensor Setup menu

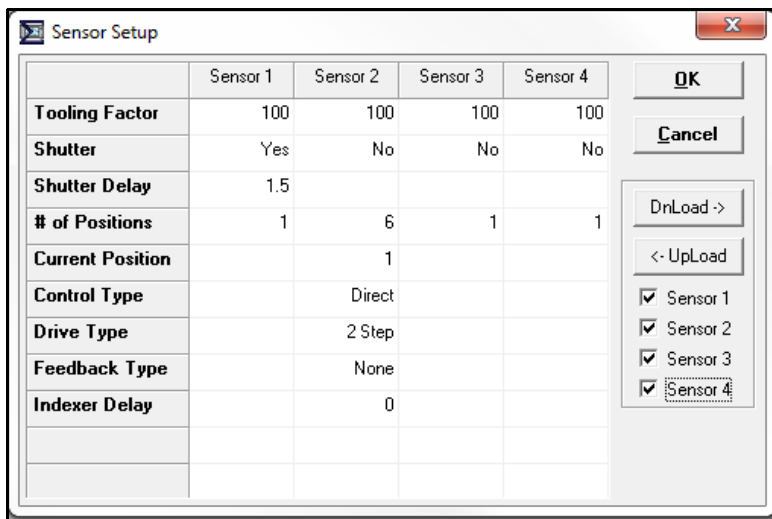

- OK** ..... Closes the Sensor Setup menu and saves the data to memory. Be sure to select **File >> Save Database** or **Save As Database** to save any changes to the database (.mdb) file.
- Cancel** ..... Closes the Sensor Setup menu and cancels any changes.
- Download->** ..... Click to download sensor data from the SQC-310 Comm software to SQC-310. The existing SQC-310 data will be overwritten.
- <-Upload** ..... Click to upload sensor data from SQC-310 to the SQC-310 Comm software. The existing SQC-310 Comm software data will be overwritten.
- Sensor 1 to 4.** ..... Checks all sensors for which data will be uploaded/downloaded when the corresponding button is pressed.



Sensor parameter inputs become available automatically when multi-pocket sensors are requested in the # of positions parameter. For a complete list of parameters, definitions, usage, and the range of acceptable values for each parameter, refer to [section 3.12.3, Sensors and Sources Menu, on page 3-36](#).

### 5.5.5 Source Setup Menu

In the Instrument window toolbar, click **Edit >> Sources...** to display the Source Setup menu and edit the parameters of sources that are connected to each SQC-310 source output. Four sources are displayed but SQC-310 may only have two source outputs (see [Figure 5-9](#)).

**NOTE:** Source setup is closely linked to Digital I/O definitions. Changing a source may cause SQC-310 to alter its internal I/O definitions. For this reason, the software must be connected to SQC-310. Click **Download** to verify and modify SQC-310 configuration before selecting **OK** to close the Source Setup menu and save the data to memory.

Figure 5-9 Source Setup menu

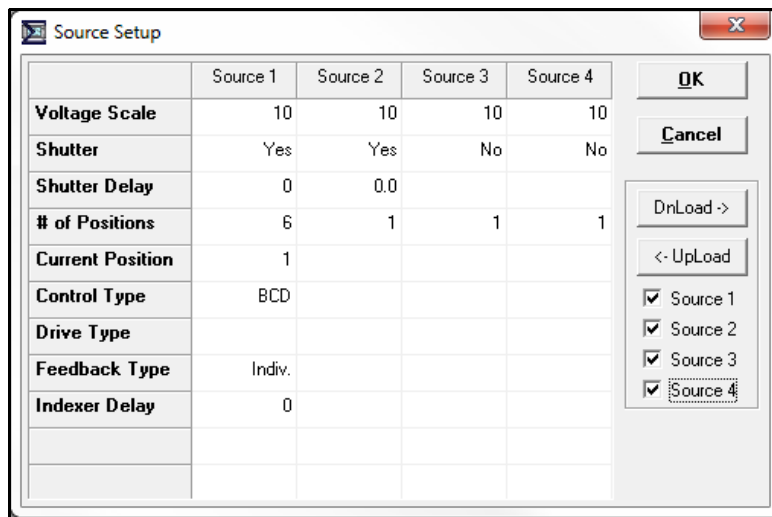

- OK** ..... Closes the Source setup menu and saves the data to memory. Be sure to select **File >> Save Database** or **Save As Database** to save any changes to the database (.mdb) file.
- Cancel** ..... Closes the Source Setup menu and cancels any changes.
- Download->** ..... Click to download source data from the SQC-310 Comm software to SQC-310. The existing SQC-310 data will be overwritten.

**<-Upload** . . . . . Click to upload source data from SQC-310 to the SQC-310 Comm software. The existing SQC-310 Comm software data will be overwritten.

**Sources 1 to 4.** . . . . . Checks all sources for which data will be uploaded/downloaded when the corresponding button is pressed.

Source parameter inputs become available automatically when multi-pocket sources are request in the # of positions parameter. For a complete list of parameters, definitions, usage, and the range of acceptable values for each parameter, refer to [section 3.12.3, Sensors and Sources Menu, on page 3-36](#).

### 5.5.6 Digital I/O Setup Menu

In the Instrument window toolbar, click **Edit >> Digital I/O...** to display the Digital I/O Setup menu that allows the mapping of named digital input and relay functions to physical inputs and relays.

**NOTE:** I/O setup is closely linked to sensor and source definitions. Changing a Sensor or Source may cause SQC-310 to alter its internal I/O definitions. For this reason, SQC-310 must be connected. Click **Download** to verify and modify SQC-310 configuration before selecting **OK** to close the Digital I/O Setup menu and save the data to memory.

Figure 5-10 Digital I/O Setup menu - Show Relays

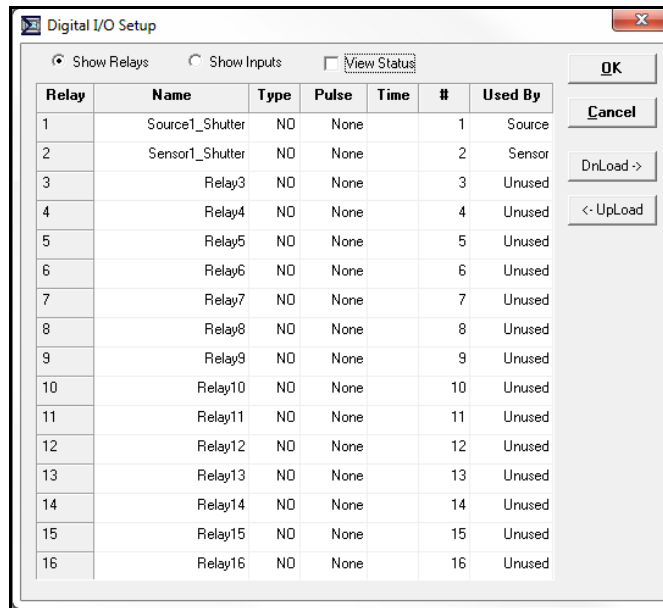

- OK** ..... Closes the Digital I/O Setup menu and saves the data to memory. Be sure to select **File >> Save Database** or **Save As Database** to save any changes to the database (\*.mdb) file.
- Cancel** ..... Closes the Digital I/O Setup menu and cancels any changes.
- Download->** ..... Click to download sensor data from the SQC-310 Comm software to SQC-310. The existing SQC-310 data will be overwritten.
- <-Upload** ..... Click to upload sensor data from SQC-310 to the SQC-310 Comm software. The existing SQC-310 Comm software data will be overwritten.

If the **Show Relays** button is selected, All relays and pertinent information will be displayed in columns that can be edited (refer to [Figure 5-10](#)).

- Name** ..... A descriptive name for the relay. For relays that have been assigned by SQC-310, this will overwrite the SQC-310 assigned default name. However, the function of the relay remains as originally defined in SQC-310. The relay name can be returned to default by selecting the relay on the SQC-310 System/Relays menu and pressing **Set to Default** (refer to [section 3.12.1 on page 3-27](#)).
- Type** ..... Normally Open (NO) contacts or Normally Closed (NC) contacts. SQC-310 implements the NO/NC function using firmware. All relays are normally open and will open when the SQC-310 is turned off.
- Pulses** ..... Selecting **None** causes the relay to activate when the logical relay function is true, and deactivate when it is false. Some multi-crystal sensors require one or two pulses for activation.
- Time** ..... The time (in seconds) that the relay activates if one or two pulses are selected.
- Relay #** ..... The physical relay assigned to this logical relay function.

**Used By** . . . . . Indicates if a relay function is defined by a sensor, source, or logic statement. A relay can be controlled by only a single function. Function is automatically designated by SQC-310 and cannot be edited.

If the **Show Inputs** button is selected, All inputs and pertinent information will be displayed in columns that can be edited (see [Figure 5-11](#)).

Figure 5-11 Digital I/O Setup menu - Show Inputs

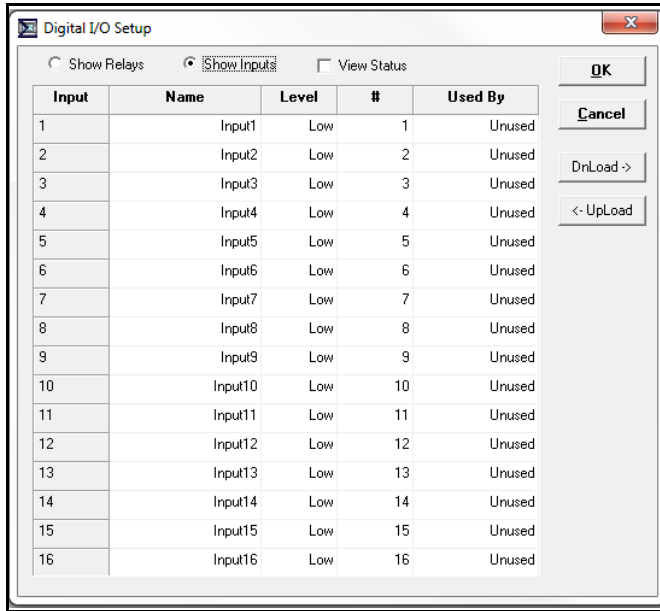

**Name** . . . . . A descriptive name for the input. For inputs that have been assigned in SQC-310, this will overwrite the SQC-310 assigned default name. However, the function of the input remains as originally defined by SQC-310. The input name can be returned to its default by selecting the relay on the SQC-310 System/Inputs menu and pressing **Set to Default** (refer to [section 3.12.1 on page 3-27](#)).

**Active Level** . . . . . The level, high (5 V) or low (0 V) that triggers the input.

**Input #** . . . . . The physical input assigned to this logical input function.

**Used By** . . . . . Indicates if an input function is defined by a sensor, source, or logic statement. Since multiple logic statements may use an input in the IF condition, only the first use is listed. Function is automatically designated by SQC-310 and cannot be edited.

When either the **Show Relays** or **Show Inputs** button is clicked, the **View Status** may be selected. View Status monitors the state of the SQC-310 inputs and relays. Similar to the SQC-310 display, relays and inputs whose state is currently true are displayed in green. False is displayed in red.

### 5.5.7 Logic Statements Menu

In the Instrument window toolbar, click **Edit >> Logic...** to display the Logic Statements menu. Logic statements allow the programming of SQC-310 to respond to inputs and activate relays, based on a variety of process conditions (see Figure 5-12).

**NOTE:** Logic statements are closely linked to digital I/O definitions. Changing a statement may cause SQC-310 to alter internal I/O definitions. SQC-310 must be connected and any changes made must be downloaded to verify and modify the SQC-310 configuration before **OK** can be selected to close the Logic Statements menu and save the data to memory.

Figure 5-12 Logic Statements menu

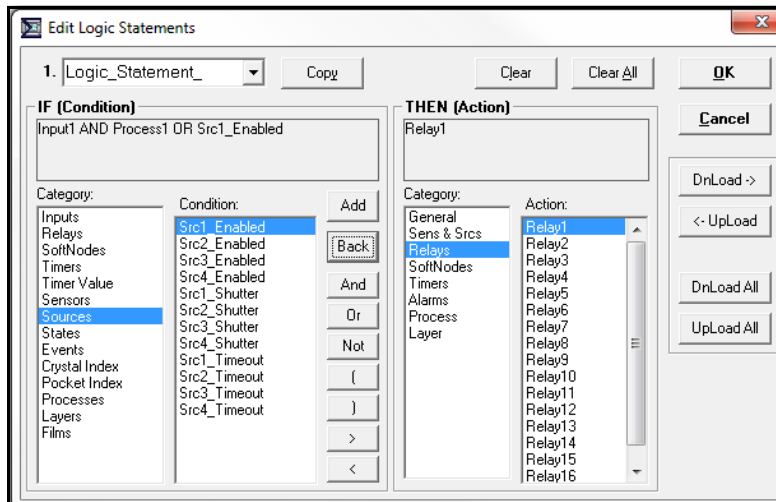

- OK** ..... Closes the Logic Statements menu and saves the data to memory. Be sure to select **File >> Save Database** or **Save As Database** to save any changes to the database (\*.mdb) file.
- Cancel** ..... Closes the Logic Statements menu and cancels any changes.
- Logic Statement** ..... List all 32 possible logic statements. The logic statement number displayed is the logic statement that will be edited.
- Copy** ..... Copies the displayed logic statement and stores it.
- Paste** ..... Displayed after the copy button is pressed. Replaces the displayed logic statement with the stored logic statement.
- Clear** ..... Clears the current logic statement.
- Clear All.** ..... Clears all logic statements.
- DnLoad->** ..... Click to download the displayed logic statement from the SQC-310 Comm software to SQC-310. The existing SQC-310 data will be overwritten. Ideal for testing the statements.
- <-UpLoad.** ..... Click to upload the displayed logic statement from SQC-310 to the SQC-310 Comm software. The existing SQC-310 Comm software data will be overwritten.
- DnLoad All->** ..... Click to download all logic statements from the SQC-310 Comm software to SQC-310. The existing SQC-310 data will be overwritten.
- <-UpLoad All.** ..... Click to upload all logic statements from SQC-310 to the SQC-310 Comm software. The existing SQC-310 Comm software data will be overwritten.

### 5.5.7.1 Creating Logic Statements

A logic statement consists of two parts. The first part of the string (IF) indicates the condition that must be satisfied. The second part (THEN) indicates the action that takes place once the condition has been satisfied.

- 1 Select a logic statement.
- 2 Click on the statement name to edit the name.
- 3 To create the IF condition, select a category and a specific condition for that category. Click **Add** to add the condition to the IF string. To add more conditions to the IF statement, add an operator such as AND, OR, or NOT and select another condition. If a mistake is made, click **Back** to delete the last entry in the IF statement. If SQC-310 is connected, click **Check** to verify the logic statement is correct.
- 4 To create the THEN action, select a category and a specific action for that category. Only one action is allowed per logic statement. However, a SoftNode can be selected as an action and used as an input to another logic statement (refer to [section 3.12.2, Logic Menu, on page 3-30](#) for more details).

For more complex logic statements, logical operators such as AND, OR, NOT, parentheses ( ), greater than >, and less than < can be added. Parenthesis are used to group logic conditions, for example, IF (Input1 AND Input2) OR Input3. Every open parenthesis "(" must have a matching closed parentheses ")." The less than (<) and greater than (>) operators are used only with timer conditions.

For a complete list of parameters, definitions, usage, and the range of acceptable values for each parameter (refer to [section 3.12.2, Logic Menu, on page 3-30](#)).

### 5.5.8 System Setup Menu

In the Instrument window, click **Edit >> Systems...** to display the System Setup menu and edit general system parameters (see [Figure 5-13](#)).

Figure 5-13 System Setup menu

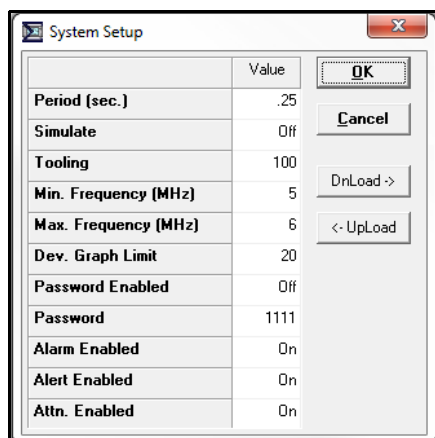

- OK** ..... Closes the System Setup menu and saves the data to memory. Be sure to select **File >> Save Database** or **Save As Database** to save any changes to the database (.mdb) file.
- Cancel** ..... Closes the System Setup menu and cancels any changes.
- Download->** ..... Click to download the current System settings from the SQC-310 Comm software to SQC-310. The existing SQC-310 data will be overwritten.
- <-Upload** ..... Click to upload the current System settings from SQC-310 to the SQC-310 Comm software. The existing SQC-310 Comm software data will be overwritten.

For a complete list of parameters, definitions, usage, and the range of acceptable values for each parameter (refer to [System Menu on page 3-25](#)).

## 5.6 Graph Menu

On the Main window toolbar, click **Edit >> Graphs...** to display the Graphs menu and edit the Main window graph axis and grid settings (see [Figure 5-14](#)).

Figure 5-14 Graph menu

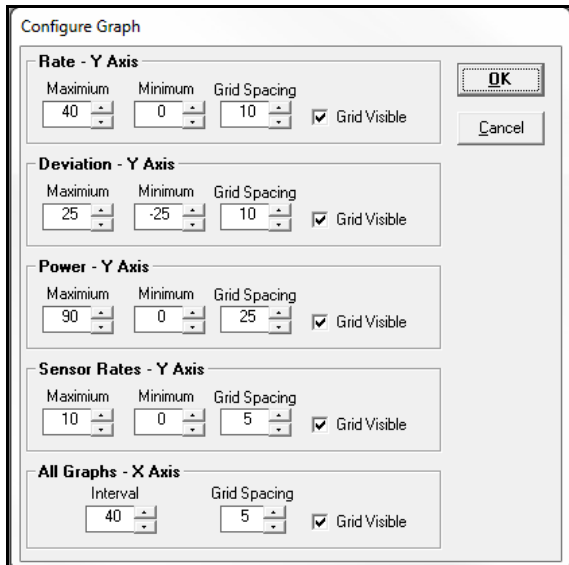



- OK** ..... Closes the Graph menu. Saves all changes.
- Cancel** ..... Closes the Graph menu. Does not save changes.
- Rate - Y-Axis** ..... Sets the maximum and minimum value for rate displayed on the Y-axis, in Å/s. Grid spacing can be also be set or disabled for rate.
- Deviation - Y-Axis** ..... Sets the maximum and minimum value for deviation displayed on the Y-axis, in %. Grid spacing can be also be set or disabled for deviation.
- Power - Y-Axis** ..... Sets the maximum and minimum value for power displayed on the Y-axis, in %. Grid spacing can be also be set or disabled for power.
- Senor Rates - Y-Axis** ..... Sets the maximum and minimum value for sensor rates displayed on the Y-axis, in %. Grid spacing can be also be set or disabled for sensor rates.
- All Graphs - X-Axis** ..... Sets the maximum and minimum time value displayed on the X-axis. Grid spacing can be also be set or disabled for time.

## 5.7 Communications Setup Menu

On the Main window toolbar, click **Edit >> Communications...** to display the communications setup menu. This menu allows for setup and troubleshooting of the SQC-310 communications (see [Figure 5-15](#)).

Figure 5-15 Comm Setup menu

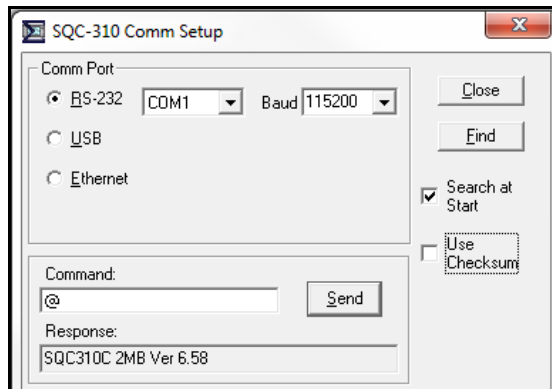

For initial setup follow these steps:

- 1 Verify SQC-310 power switch is in the on position and connected to the computer with the proper cable (USB cable, straight-through RS-232 cable, or Ethernet cable) (refer to [Chapter 4.1, Communications](#) for setup details).

- 2 Select the proper communications method and set the required parameters.

**RS-232** . . . . . Select for RS-232 communications. Select the proper communications port for the computer. If a USB to RS-232 adapter is used, verify the communication port assignment in the Windows device manager. Set the Baud rate in the drop down menu to match the SQC-310 System menu RS-232 Comm. baud setting (refer to [section 3.12 on page 3-25](#) for details).

**USB** . . . . . Select for USB communications. SQC-310 units currently connected to a computer via USB will be recognized and added to the displayed on the list. Select the desired SQC-310.

**Ethernet.** . . . . . Select for Ethernet communications. Enter the proper SQC-310 Ethernet port (typically 2101) and TCP/IP address. TCP/IP address is typically 192.168.1.200. If unknown, Click the **Setup** button to search for the IP address.

Other options available on this window are:

**Close** . . . . . Exits the Communications Setup menu. Saves any changes.

**Find** . . . . . Used for testing communications. Sends the Hello command (@) over the selected communications port. SQC-310 should respond with version information in the response dialog box. Ignore the extra characters that begin and end the version information. If the communications type is changed, and Find does not find the connected SQC-310, try exiting and restarting SQC-310 Comm software. This will reinitialize the desired communications port.

- Search at Start** . . . . . Automatically sends the Hello command (@) over the last selected communications method when the SQC-310 Comm software is launched. This checkbox option is saved when the **Close** button is clicked. If the SQC-310 Comm software is used often without being connected to SQC-310, clear this option.
- Use Checksum** . . . . . Communications between the SQC-310 Comm software and SQC-310 include a checksum to verify data integrity. This option should remained selected unless instructed to do otherwise by support personnel.
- Send(Command)**. . . . . Sends the command entered into the command box via communications to SQC-310. Message length and checksum (if used) are automatically calculated and sent. Type commands in ASCII format (refer to [section 4.2, SQC-310 Communications Protocol](#), on page 4-8 for details).
- Response** . . . . . The response from SQC-310 is displayed in this dialog box. Responses will be displayed in ASCII format (refer to [section 4.2, SQC-310 Communications Protocol](#), on page 4-8 for details).

## 5.8 View Menu

On the Main window toolbar, click **View** to display a series of options for different Main window graphs available. Selecting a graph will replace the current Main window graph. An option for a **Sensor Readings** window is also available.

- Output Rate Graph** . . . . . On the Main window, displays the output rate over time.
- Output Deviation Graph**. . . . . On the Main window, displays the output deviation over time.
- Output Power Graph** . . . . . On the Main window, displays the output power over time.
- Sensor Rate Graph**. . . . . On the Main window, displays the individual sensor rates over time.

**Sensor Readings** . . . . . Displays the Sensor Reading window that displays live sensor readings for Rate (Å/s), Thick(ness) (kÅ) and Freq(uecy) (Hz) (see Figure 5-16).

Figure 5-16 Sensor Readings window

	Rate (Å/s)	Thick (kÅ)	Freq. (Hz)
Sensor 1	.0	0.000	Fail
Sensor 2	.0	0.000	Fail
Sensor 3	.0	0.000	Fail
Sensor 4	.0	0.000	Fail

## 5.9 Help Menu

On the Main window toolbar, click **Help** to display a **Help** option and an **About** option. The **Help** option contains the information presented in this chapter.

**NOTE:** The **Help** option is not available on Windows 7/8 operating systems.

The **About** window displays the SQC-310 Comm software revision and technical support information (see Figure 5-17).

Figure 5-17 About window

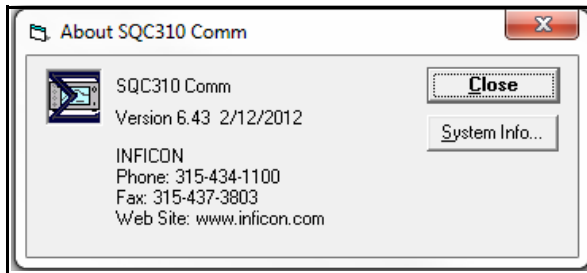

On the **About** window, click system information to display detailed information about the computer and operating system.

**NOTE:** This feature may not be available on all Windows operating systems.

# Chapter 6

## Troubleshooting and Maintenance

### 6.1 Troubleshooting

If SQC-310 does not function as expected, or appears to have diminished performance, the following Symptom/Cause/Remedy chart may be helpful (see [Table 6-1](#)). Additional troubleshooting information can be found in the operating manuals for sensors, located on the Thin Film Instrument and Sensor Manuals CD. If the problem cannot be resolved, contact INFICON (refer to [section 1.3 on page 1-5](#)).



**WARNING**

The SQC-310 has no user-serviceable components.

Refer all maintenance to qualified INFICON personnel.

Table 6-1 Symptom/Cause/Remedy Chart

SYMPTOM	CAUSE	REMEDY
<b>SQC-310 does not turn on.</b>	Line cord is not plugged into SQC-310 or rear panel power switch is not on.	Connect line cord. Set the rear panel power switch to position 1 (ON).
	Incorrect line voltage.	Line voltage must be within SQC-310 line voltage specification (refer to <a href="#">section 1.4.5 on page 1-7</a> ).
	Fuse open.	Remove the fuse drawer from the power inlet and examine both fuses, or use an ohmmeter to check the fuses. Replace open fuses with the specified fuse (see <a href="#">section 6.5 on page 6-17</a> ).
	SQC-310 is malfunctioning.	Contact INFICON service department (refer to <a href="#">section 1.3 on page 1-5</a> ).

Table 6-1 Symptom/Cause/Remedy Chart (continued)

SYMPTOM	CAUSE	REMEDY
<b>SQC-310 “locks up.”</b>	Covers / panels not installed or not secured.	Install / securely fasten all covers and panels.
	Electrical noise is being picked up by cables connected to SQC-310.	Locate the sensor, oscillator cables, source output cables, I/O cables, and line cord at least 30.5 cm (1 ft.) away from high voltage / high power cables and other sources of electrical noise.
	Inadequate system grounding.	Ground wires or straps should be short with large surface area to minimize impedance to ground.  Ground wires or straps must connect to an appropriate earth ground (refer to <a href="#">section 1.2.3 on page 1-3</a> ).
	SQC-310 is malfunctioning.	Contact INFICON service department (refer to <a href="#">section 1.3 on page 1-5</a> ).
<b>Stored parameter values are lost when SQC-310 is turned on.</b>	SQC-310 is malfunctioning.	Contact INFICON service department (refer to <a href="#">section 1.3 on page 1-5</a> ).

Table 6-1 Symptom/Cause/Remedy Chart (continued)

SYMPTOM	CAUSE	REMEDY
<p><b>Frequency reading in Sensor Information screen is unstable or drifting (not a normal frequency decrease associated with material being deposited on the crystal).</b></p>	<p>Temperature of the crystal is unstable (an AT-cut crystal may drift as much as 10 Hz/°C).</p>	<p>Control the vacuum chamber temperature.</p> <p>Move the crystal farther away from the source (at least 25.4 cm (10 in.) from source).</p> <p>Check sensor water cooling for correct flow and temperature. Refer to the sensor operating manual.</p> <p>Clean or replace the crystal holder. Refer to the sensor operating manual for cleaning instructions.</p> <p>Use SPC-1157-G10 thermal shock crystals designed to minimize frequency shifts due to heat load.</p>

Table 6-1 Symptom/Cause/Remedy Chart (continued)

SYMPTOM	CAUSE	REMEDY
<b>Frequency reading in Sensor Information screen is unstable or drifting (not a normal frequency decrease associated with material being deposited on the crystal).</b>	Humidity level on the crystal is changing. Moisture being absorbed or exuded from the crystal surface.	Avoid condensation by turning off cooling water to sensor before opening the vacuum chamber to air, and then flow heated water above the dew point of the room through the sensor when the chamber is open.
	Crystal or crystal holder crystal seating surface scratched or dirty.	Replace crystal.  Clean the crystal seating surface inside the crystal holder or replace crystal holder. Refer to sensor operating manual for cleaning instructions.
	Bad in-vacuum cable or bad oscillator cables.	Use an ohmmeter to check electrical continuity and isolation of cables.
	SQC-310 or oscillator is malfunctioning.	Test the SQC-310 and oscillator using the oscillator test mode (see <a href="#">section on page 6-17</a> ).  Substitute a known good SQC-310 (or other QCM).  Substitute a known good oscillator.  Substitute a PN 760-601-G2 Sensor Emulator or a known good sensor for the sensor.
<b>Frequency reading in Sensor Information screen is an incorrect value.</b>	Excessive cable length between oscillator and crystal is causing a self-oscillation at a frequency different than the crystal frequency.	In-vacuum cable length should not exceed 78.1 cm (30.75 in.).  Use the 15.2 cm (6 in.) cable between oscillator and feedthrough.

PN 074-550-P1E



Table 6-1 Symptom/Cause/Remedy Chart (continued)

SYMPTOM	CAUSE	REMEDY
<b>Frequency reading in Sensor Information screen is an incorrect value.</b>	SQC-310 or oscillator is malfunctioning.	Test the SQC-310 and oscillator using the oscillator test mode (see <a href="#">section on page 6-17</a> ).  Substitute a known good SQC-310 (or other QCM).  Substitute a known good oscillator.  Substitute a PN 760-601-G2 Sensor Emulator or a known good sensor for the sensor.
<b>Crystal Fail is displayed.</b>	Failed crystal, or no crystal in sensor.	Install a new crystal.
	Two crystals were installed or crystal is upside down.	Remove extra crystal.  Reverse crystal orientation. Inspect crystal for scratches; if scratched, replace with new crystal.
	Built-up material at crystal holder aperture is touching the crystal.	Clean or replace the crystal holder. Refer to the sensor operating manual for cleaning instructions.
	Crystal frequency is not within the frequency range of SQC-310.	Use a crystal with starting frequency appropriate for SQC-310 frequency range.  Change the Min / Max Frequency settings in the System Menu screen.
	Oscillator and sensor not connected to the Sensor channel(s) set to On in the Edit Layer screen.	Connect oscillator and sensor to all active Sensor channel(s).

Table 6-1 Symptom/Cause/Remedy Chart (continued)

SYMPTOM	CAUSE	REMEDY
<b>Crystal Fail is displayed.</b>	Excessive cable length between oscillator and crystal.	In-vacuum cable length should not exceed 78.1 cm (30.75 in.).  Use the 15.2 cm (6 in.) cable between oscillator and feedthrough.
	Bad sensor/feedthrough, or bad in-vacuum cable, or bad BNC cable.  SQC-310 or oscillator is malfunctioning.	Use an ohmmeter to check electrical continuity and isolation of sensor head, feedthrough, in-vacuum cable, and both BNC cables. Refer to the sensor operating manual for detailed troubleshooting information.  Substitute known good BNC cables.  Substitute a known good in-vacuum cable.  Substitute a known good sensor/feedthrough.  Substitute a PN 760-601-G2 Sensor Emulator for the sensor.  Test the SQC-310 and oscillator using the oscillator test mode (see <a href="#">section 6.1.1 on page 6-14</a> ).  Substitute a known good SQC-310 (or other QCM).  Substitute a known good oscillator.

Table 6-1 Symptom/Cause/Remedy Chart (continued)

SYMPTOM	CAUSE	REMEDY
<b>Crystal Fail is displayed during deposition before “normal” life of crystal is exceeded.</b>	Crystal is being hit by small droplets of molten material from the evaporation source.	Use a shutter to shield the sensor during source conditioning.  Move the crystal farther away (at least 25.4 cm (10 in.)) from the source.
	Damaged crystal or deposited material is causing stress to crystal.	Replace the crystal.  Use an Alloy crystal if appropriate for deposited material.
	Material build-up on crystal holder is partially masking the crystal surface.	Clean or replace the crystal holder. Refer to the sensor operating manual for cleaning instructions.
	Shutter is partially obstructing deposition flux or sensor is poorly positioned, causing uneven distribution of material on crystal.	Visually check crystal for an uneven coating, and if present, correct shutter or sensor positioning problem.
	Xtal Quality or Xtal Stability are enabled and triggering a Crystal Fail.	Poor Rate control is triggering Xtal Quality (see <a href="#">section 7.5 on page 7-5</a> ).  Unstable/noisy crystal is triggering Xtal Stability. Replace crystal.  External condition (e-beam arcing, thermal changes, etc.) is triggering Xtal Stability. Correct the external condition.  Xtal Quality and/or Xtal Stability settings are too sensitive for the application. Change the values, or disable Xtal Quality and/or Xtal Stability (refer to <a href="#">section 3.11 on page 3-18</a> ).

Table 6-1 Symptom/Cause/Remedy Chart (continued)

SYMPTOM	CAUSE	REMEDY
<b>Crystal Fail is displayed during deposition before “normal” life of crystal is exceeded.</b>	Crystal oscillation is weak due to excessive cable length between oscillator and crystal.	In-vacuum cable length should not exceed 78.1 cm (30.75 in.).  Use the 15.2 cm (6 in.) cable between oscillator and feedthrough.
<b>Crystal Fail is displayed when vacuum chamber is opened to air.</b>	Crystal was near the end of its life; opening to air causes film oxidation, which increases film stress.	Replace the crystal.
	Excessive moisture accumulation on the crystal.	Avoid condensation by turning off cooling water to sensor before opening the vacuum chamber to air, and then flow heated water above the dew point of the room through the sensor when the chamber is open.

Table 6-1 Symptom/Cause/Remedy Chart (continued)

SYMPTOM	CAUSE	REMEDY
<b>Rate, Thickness, and Frequency readings are noisy.</b>	Excessive cable length between oscillator and crystal.	In-vacuum cable length should not exceed 78.1 cm (30.75 in.).  Use the 15.2 cm (6 in.) cable between oscillator and feedthrough.
	Electrical noise is being picked up by cables connected to SQC-310.	Locate the sensor, oscillator cables, source output cables, I/O cables, communications cable, and line cord at least 30.5 cm (1 ft.) away from high voltage / high power cables and other sources of electrical noise.
	Inadequate system grounding.	Ground wires or straps should be short with large surface area to minimize impedance to ground.  Ground wires or straps should connect to an appropriate earth ground (refer to <a href="#">section 1.2.3 on page 1-3</a> ).

Table 6-1 Symptom/Cause/Remedy Chart (continued)

SYMPTOM	CAUSE	REMEDY
<b>Thickness reading has large excursions during deposition.</b>	Mode hopping due to damaged crystal.	Replace the crystal.
	Crystal is near the end of its life.	Replace the crystal.
	Scratches or foreign particles on the crystal holder crystal seating surface.	Clean the crystal seating surface inside the crystal holder or replace crystal holder. Refer to sensor operating manual for cleaning instructions.
	Uneven coating onto crystal.	A straight line from center of source to center of crystal should be perpendicular to face of crystal.
	Particles on crystal.	Replace crystal. Remove source of particles.
	Intermittent cables or connections.	Use an ohmmeter to check electrical continuity / isolation of sensor head, feedthrough, in-vacuum cable, and BNC cables. Refer to the sensor operating manual for detailed troubleshooting information.
	Inadequate cooling of crystal.	Check water flow rate and temperature for sensor cooling.
<b>Thickness reading has large excursions during source warm-up or when source shutter is opened (usually causes Thickness reading to decrease) and after the termination of deposition (usually causes Thickness reading to increase).</b>	Crystal not properly seated or crystal holder crystal seating surface is dirty.	Check crystal installation. Clean the crystal seating surface inside the crystal holder or replace crystal holder. Refer to sensor operating manual for cleaning instructions.

Table 6-1 Symptom/Cause/Remedy Chart (continued)

SYMPTOM	CAUSE	REMEDY
<b>Thickness reading has large excursions during source warm-up or when source shutter is opened (usually causes Thickness reading to decrease) and after the termination of deposition (usually causes Thickness reading to increase).</b>	Excessive heat input to the crystal.	If heat is due to radiation from the evaporation source, move sensor farther away (at least 25.4 cm (10 in.)) from source.  Use SPC-1157-G10 thermal shock crystals designed to minimize frequency shifts due to heat load.
	Inadequate cooling of crystal.	Check water flow rate and temperature for sensor cooling.
	Crystal is being heated by electron flux.	Use a sputtering sensor for non-magnetron sputtering.
	Crystal is being hit by small droplets of molten material from the evaporation source.	Use a shutter to shield the sensor during source conditioning.  Move the crystal farther away (at least 25.4 cm (10 in.)) from the source.
	Intermittent connection occurring in sensor or feedthrough with thermal variation.	Use an ohmmeter to check electrical continuity / isolation of sensor head, feedthrough, and in-vacuum cable. Refer to the sensor operating manual for detailed troubleshooting information.

Table 6-1 Symptom/Cause/Remedy Chart (continued)

SYMPTOM	CAUSE	REMEDY
<b>Thickness reproducibility is poor.</b>	Erratic evaporation flux characteristics.	Move sensor to a different location.  Check the evaporation source for proper operating conditions.  Ensure relatively constant pool height and avoid tunneling into the melt.  Assign multiple sensors to the source.
	Material does not adhere well to the crystal.	Check for contamination on the crystal surface.  Evaporate an intermediate layer of appropriate material onto the crystal to improve adhesion.  Use gold, silver, or alloy crystals, as appropriate.
<b>Rate control is poor.</b>	PID control loop parameters are not optimized.	Test in Manual mode to ensure a stable rate is possible.  Change PID control loop parameters (see <a href="#">section 7.5 on page 7-5</a> ).
	Period and/or Rate Filter Alpha parameters are not optimized.	Change Period and/or Rate Filter Alpha values (refer to <a href="#">section 3.12 on page 3-25</a> ).
	Electron beam sweep frequency “beating” with the SQC-310 measurement frequency.	Adjust the sweep frequency so it is not in phase with the SQC-310 measurement frequency.

PN 074-550-P1E



Table 6-1 Symptom/Cause/Remedy Chart (continued)

SYMPTOM	CAUSE	REMEDY
<b>Source output of SQC-310 is not functioning properly.</b>	A voltage is being applied to the source output cable by the source power supply or other equipment.	Remove the cause of the applied voltage.
	Source output voltage range or polarity is not appropriate for the source power supply.	Check the required input polarity and input voltage of the source power supply. In the Sensors & Sources Menu screen, set Voltage Scale to the appropriate polarity and voltage range.
	Source output cable wiring is incorrect.	Check source output cable wiring (refer to <a href="#">section 2.4 on page 2-5</a> ).
	SQC-310 is malfunctioning.	Substitute a known good SQC-310 (or other QCM).
<b>SQC-310 Comm software does not install correctly or does not function correctly.</b>	Host computer has incompatible operating system or incompatible version of operating system.	Check that operating system and version are compatible with SQC-310 Comm software (refer to <a href="#">Chapter 5</a> ).
<b>Communication cannot be established between the host computer and SQC-310.</b>	Communications cable is not connected properly to SQC-310 or host computer.	Check cable connections.
	Communication settings in SQC-310 or SQC-310 Comm software are incorrect.	Refer to <a href="#">section 3.12 on page 3-25</a> and <a href="#">section 5.7 on page 5-20</a> .
	SQC-310 Comm software version is not compatible with SQC-310 firmware version.	Contact INFICON technical support (refer to <a href="#">section 1.3 on page 1-5</a> ).
<b>RS-232 communication issue.</b>	RS-232 cable is not the correct type.	Use straight-through RS-232 cable (refer to <a href="#">section 4.1.1 on page 4-1</a> ).
<b>USB communication issue.</b>	USB device driver is not installed correctly.	Refer to <a href="#">section 4.1.2 on page 4-2</a> .

Table 6-1 Symptom/Cause/Remedy Chart (continued)

SYMPTOM	CAUSE	REMEDY
Ethernet communication issue.	Ethernet network settings in host computer are incorrect.	Refer to <a href="#">section 4.1.3 on page 4-2</a> .
	Ethernet IP address setting in SQC-310 Comm software does not match IP address of SQC-310 Ethernet module.	Change Ethernet module IP address or SQC-310 Comm software IP address (refer to <a href="#">section 4.1.3.2 on page 4-7</a> ).
	Straight-through Ethernet cable is not auto-detected by an older host computer.	Use a cross-over Ethernet cable for a direct connection to a host computer that does not auto-detect cable type.

### 6.1.1 Using the OSC-100A Oscillator Test Function

OSC-100A oscillators have a test feature to help isolate persistent crystal fail problems (see [Figure 6-1](#)). To activate the test feature, press the **Push to Test** button using a small, pointed object, such as a pen or small screwdriver. This connects the internal test crystal to the circuit instead of the normal **Sensor** connector. If SQC-310 and the oscillator are functioning correctly, the **Sensor Information** will display a Frequency of approximately 5.5 MHz while this button is depressed. Once the **Push to Test** button is released, the oscillator returns to normal operation and the internal test crystal is no longer in use.

If the **Sensor Information** screen displays a Frequency of approximately 5.5 MHz while the **Push To Test** button is depressed, the problem has been isolated to be in the path between the oscillator and the sensor head. If the **Sensor Information** screen continues to display Frequency of zero while the **Push To Test** button is depressed, the problem is either the programming of the sensor selection, in the electronics of the oscillator, or SQC-310.

Figure 6-1 OSC-100A oscillator



PN 074-550-P1E

## 6.2 Cleaning

Use a damp cloth, wetted with water or a mild detergent, to clean the outer surfaces.

## 6.3 Upgrading Firmware

The SQC-310 firmware can be upgraded through the RS-232 port. Some restrictions apply. Contact INFICON for instructions and availability of firmware upgrades ([section 1.3 on page 1-5](#)). Please record and have the firmware version (displayed at power up as Ver x.xx) and hardware version (displayed at power up as Hw x) available when contacting INFICON for upgrades.

## 6.4 Clearing the Memory

SQC-310 has two ways to clear system memory. Both involve pressing and holding a combination of buttons and the control knob. [Figure 6-2](#) displays the number designations given to each button and the control knob. These are the same number designations used for entering system passwords (refer to [section 3.12](#) for more information on passwords).



### CAUTION

**Memory clearing procedures cannot be reversed. Be sure to back up the configuration file using SQC-310 Comm software, if possible, before attempting to clear system memory.**

Figure 6-2 Button number designations



To clear all memory including the material index, press and hold the 1 and 6 buttons along with the control knob (7) during startup. On the bootup screen, the following should be displayed:

Loading Materials . . . . . Failed!  
Loading Films . . . . . Failed!  
Loading System . . . . . Failed!  
Loading Processes . . . . . Failed!

Once SQC-310 boots up, turn the power off and back on again. SQC-310 loads normally and displays:

Loading Materials . . . . . Done  
Loading Films . . . . . Done  
Loading System . . . . . Done  
Loading Processes . . . . . Done

If any **Failed!** messages still appear during loading, turn the power off and back on again. Only **Done** messages should appear after memory clearing is complete.

To clear all memory except the material index and set SQC-310 to factory default, press and hold the 2 and 5 buttons along with the control knob (7) during startup. All loading messages will now display **Failed!**, except Materials. Repeat the rebooting procedure described above until all loading messages display **Done**.

## 6.5 Spare Parts

Oscillator . . . . .	PN 783-500-013
BNC Cable (15.2 cm (6 in.)) . . . . .	PN 782-902-011
BNC Cable (3.0 m (10 ft.)) . . . . .	PN 782-902-012-10
BNC Cable (7.6 m (25 ft.)) . . . . .	PN 782-902-012-25
BNC Cable (15.2 m (50 ft.)) . . . . .	PN 782-902-012-50
BNC Cable (22.8 m (75 ft.)) . . . . .	PN 782-902-012-75
Fuse (500 mA) . . . . .	PN 062-0105
Fuse Drawer . . . . .	PN 051-1510
Power Cord North American (1.8 m (6 ft.)) . . . . .	PN 068-0433
Power Cord European (2.5 m (8.2 ft.)) . . . . .	PN 068-0434
Power Cord UK (2.5 m (8.2 ft.)) . . . . .	PN 803301
RS-232 straight-through Cable (3 m (10 ft.)) . . . . .	PN 068-0464
USB 2.0 A-B Cable (3 m (10 ft.)) . . . . .	PN 068-0472
Ethernet Cat5e Cable (2.1 m (7 ft.)) . . . . .	PN 068-0478

---

## Chapter 7

# Calibration Procedures

---

### 7.1 Importance of Density, Tooling and Z-Ratio

The quartz crystal microbalance is capable of precisely measuring the mass added to the face of the oscillating quartz crystal sensor. The density of this added material allows conversion of the mass information into thickness. In some instances, where highest accuracy is required, it is necessary to make a density calibration as outlined in [section 7.2](#).

Because the flow of material from a deposition is not uniform, it is necessary to account for the different amount of material flow onto the sensor compared to the substrates. This factor is accounted for in the tooling factor. The tooling factor can be experimentally established by following the guidelines in [section 7.3 on page 7-2](#).

If the Z-Ratio is not known, it could be estimated from the procedures outlined in [section 7.4 on page 7-3](#).

### 7.2 Determining Density

**NOTE:** The bulk density values retrieved from [Table A-1](#) are sufficiently accurate for most applications.

Follow the steps below to determine density value.

- 1 Place a substrate (with proper masking for film thickness measurement) adjacent to the sensor, so that the same thickness will be accumulated on the crystal and substrate.
- 2 Set density to the bulk value of the film material or to an approximate value.
- 3 Set Z-Ratio to 1.000 and tooling to 100%.
- 4 Place a new crystal in the sensor and make a short deposition (1000 to 5000 Å).
- 5 After deposition, remove the test substrate and measure the film thickness with either a multiple beam interferometer or a stylus-type profilometer.

- 6 Determine the new density value with [equation \[1\]](#):

$$\text{Density}(\text{g}/\text{cm}^3) = D_1 \left( \frac{T_x}{T_m} \right) \quad [1]$$

where:

$D_1$  = Initial density setting

$T_x$  = Thickness reading on SQC-310

$T_m$  = Measured thickness

- 7 A quick check of the calculated density may be made by programming SQC-310 with the new density value and observing that the displayed thickness is equal to the measured thickness, provided that the thickness displayed on SQC-310 has not been zeroed between the test deposition and entering the calculated density.

**NOTE:** Slight adjustment of density may be necessary in order to achieve  $T_x = T_m$ .

### 7.3 Determining Tooling

- 1 Place a test substrate in the system substrate holder.
- 2 Make a short deposition and determine actual thickness.
- 3 Calculate tooling from the relationship shown in [equation \[2\]](#):

$$\text{Tooling} (\%) = TF_i \left( \frac{T_m}{T_x} \right) \quad [2]$$

where

$T_m$  = Actual thickness at substrate holder

$T_x$  = Thickness reading on SQC-310

$TF_i$  = Initial tooling factor

- 4 Round off percent tooling to the nearest 0.1%.
- 5 When entering this new value for tooling,  $T_m$  will equal  $T_x$  if calculations are done properly.

**NOTE:** It is recommended that a minimum of three separate evaporations be made when calibrating tooling. Variations in source distribution and other system factors will contribute to slight thickness variations. An average value tooling factor should be used for final calibrations.

## 7.4 Laboratory Determination of Z-Ratio

A list of Z-Ratios for materials commonly used are available in [Table A-1](#). For other materials, Z can be calculated from the following formula:

$$Z = \left( \frac{d_q \mu_q}{d_f \mu_f} \right)^{\frac{1}{2}} \quad [3]$$

$$Z = 9.378 \times 10^5 (d_f \mu_f)^{-\frac{1}{2}} \quad [4]$$

where:

- ♦  $d_f$  = Density (g/cm<sup>3</sup>) of deposited film
- ♦  $\mu_f$  = Shear modulus (dynes/cm<sup>2</sup>) of deposited film
- ♦  $d_q$  = Density of quartz (crystal) (2.649 g/cm<sup>3</sup>)
- ♦  $\mu_q$  = Shear modulus of quartz (crystal) (3.32 x 10<sup>11</sup> dynes/cm<sup>2</sup>)

The densities and shear moduli of many materials can be found in a number of handbooks.

Laboratory results indicate that Z-Ratios of materials in thin-film form are very close to the bulk values. However, for high stress producing materials, Z-Ratios of thin films are slightly smaller than those of the bulk materials. For applications that require more precise calibration, the following direct method is suggested:

- 1** Establish the correct density value as described in [section 7.2 on page 7-1](#).
- 2** Install a new crystal and record its starting frequency,  $F_{CO}$ . The starting frequency will be displayed on the SQC-310 Main screen.
- 3** Make a deposition on a test substrate such that the percent crystal life display will read approximately 50%, or near the end of crystal life for the particular material, whichever is smaller.
- 4** Stop the deposition and record the ending crystal frequency,  $F_C$ .
- 5** Remove the test substrate and measure the film thickness with either a multiple beam interferometer or a stylus-type profilometer.



- 6 Using the density value from step 1 and the recorded values for  $F_{co}$  and  $F_c$ , adjust the Z-Ratio value in thickness equation [5] to bring the calculated thickness value into agreement with the actual thickness. If the calculated value of thickness is greater than the actual thickness, increase the Z-Ratio value. If the calculated value of thickness is less than the actual thickness, decrease the Z-Ratio value.

$$T_f = \frac{Z_q \times 10^4}{2\pi zp} \left\{ \left( \frac{1}{F_{co}} \right) A \tan \left( z \tan \left( \frac{\pi F_{co}}{F_q} \right) \right) - \left( \frac{1}{F_c} \right) A \tan \left( z \tan \left( \frac{\pi F_c}{F_q} \right) \right) \right\} \quad [5]$$

where:

- ◆  $T_f$  = Thickness of deposited film (kÅ)
- ◆  $F_{co}$  = Starting frequency of the sensor crystal (Hz)
- ◆  $F_c$  = Final frequency of the sensor crystal (Hz)
- ◆  $F_q$  = Nominal blank frequency = 6045000 (Hz)
- ◆  $z$  = Z-Ratio of deposited film material
- ◆  $Z_q$  = Specific acoustic impedance of quartz = 8765000 (kg/(m<sup>2</sup>s))
- ◆  $p$  = Density of deposited film (g/cm<sup>3</sup>)

For multiple layer deposition (for example, two layers), the Z-Ratio used for the second layer is determined by the relative thickness of the two layers. For most applications the following three rules will provide reasonable accuracies:

- ◆ If the thickness of layer 1 is large compared to layer 2, use material 1 Z-Ratio for both layers.
- ◆ If the thickness of layer 1 is thin compared to layer 2, use material 2 Z-Ratio for both layers.
- ◆ If the thickness of both layers is similar, use a value for Z-Ratio which is the weighted average of the two Z-Ratios for deposition of layer 2 and subsequent layers.

## 7.5 Control Loop

The function of the control loop parameters is to match the SQC-310 reaction to an error (between the measured deposition rate and the desired rate) to the time related characteristics of the deposition source and its power supply. There are three adjustable parameters; **P**(proportional), **I**(integral) and **D**(derivative) used to accomplish this. It is convenient to think of sources as falling into two categories "fast" or "slow" (see [section 7.5.1](#)). The tuning parameters are affected by source level, rate, sweep range or beam density, tooling and source condition.

The proportional gain (P-Term) parameter sets the rate at which the control voltage changes in response to an error signal (see [Figure 7-1](#)). Any error in the rate causes the source control voltage to ramp to a new value. When the source control voltage increases or decreases to the correct value, the value required to achieve the desired rate, the error goes to zero and the output remains constant. A higher value for this term would be a more responsive (but potentially unstable) control loop.

Figure 7-1 Proportional Gain

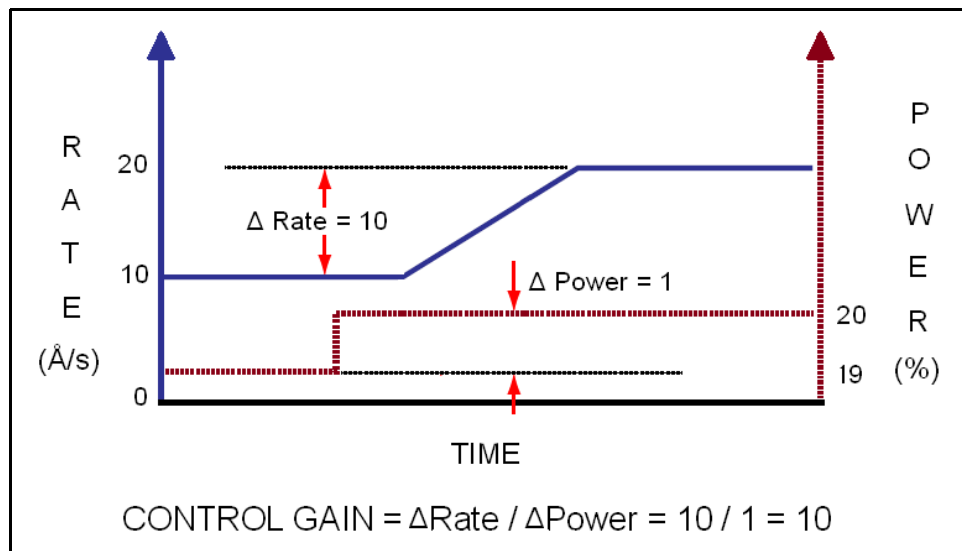

The integral time constant (I-Term) parameter is defined as the time difference between the actual start of a change in rate and the time at which approximately 66% of the rate step is achieved. It can be estimated as twice the time for the rate to go from 1/3 to 2/3 of the desired rate (see Figure 7-2.) A small value for this term causes more error correction. A large value ignores any past errors unless the error lasts for a long time.

Figure 7-2 Integral Time Constant

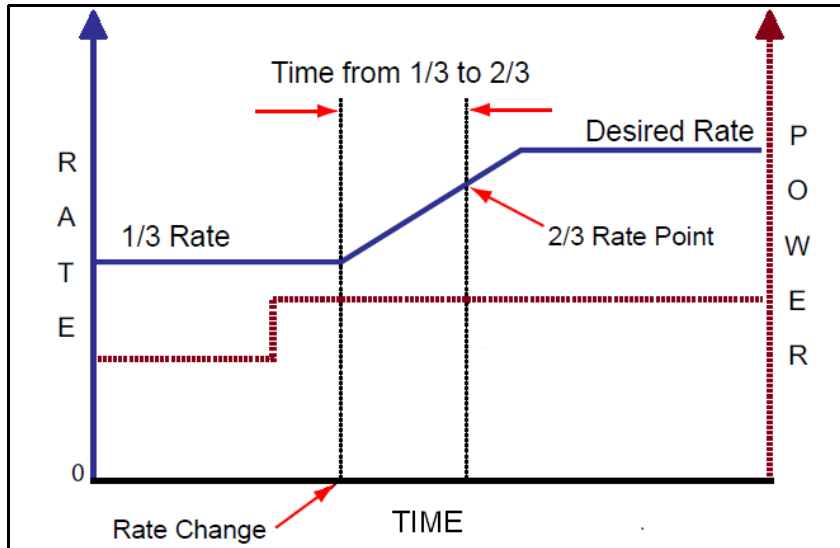

The derivative time constant (D-Term) parameter is utilized to compensate for slow responding sources such as boats and induction heated sources. This value is defined as the time difference between a change in % power and the start of an actual change in rate (see Figure 7-3.) The derivative time constant is used to monitor the rate of change of an error. A value of zero for this term ignores the rate of change of the error. A large value is used for a slow source which will take longer to develop a rate increase and longer to stop a rate increase.

Figure 7-3 Derivative Time Constant (Dead Time)

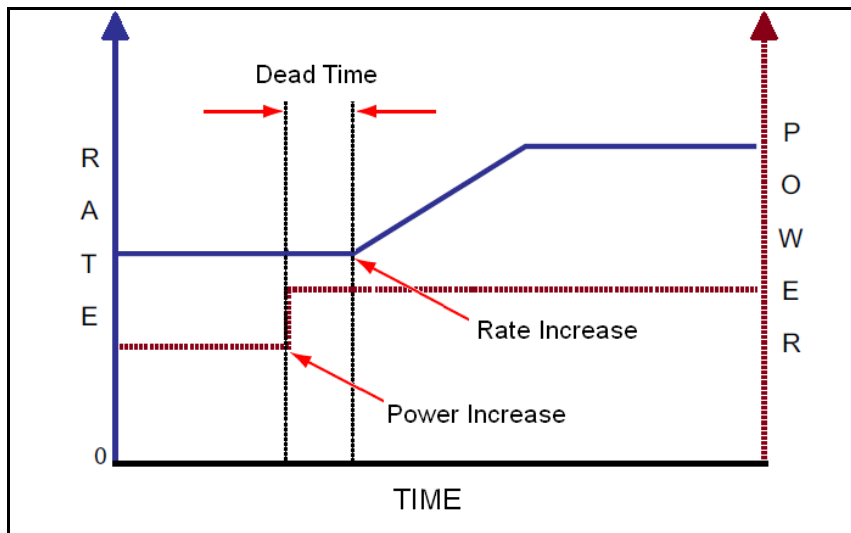

PN 074-550-P1E

### 7.5.1 Identifying a Fast or Slow Source

Classifying a source as being fast or slow is based on the time it takes for the rate to change from a change in power (delay). It is straight forward to measure the delay. Using manual power, establish a rate and allow it to become steady (refer to [Chapter 3, Operation](#) for details). Increase the source power a few percent (~5% if possible). Allow the source to again stabilize. If the delay time is greater than 1 second, the source is characterized as slow. Thermal sources, for example, are slow responding and typically free of noise transients. To avoid overshooting and constantly seeking setpoint (see [Figure 7-4](#)), slow sources may require adjustments to the PID parameters of the control loop that anticipate their long dead time and slow response to changes.

All other sources are considered fast. In general, electron beam (e-beam) sources (unless a hearth liner is used), some very small filament sources, and sputtering sources are considered fast sources. E-beam sources in particular, are often fast responding and noisy. They are also subject to arcing, which can create large electrical noise spikes which can make tuning the PID loop difficult. Fast sources may only require adjustments to the P and I parameters of the control loop.

Figure 7-4 Rate Control Behavior

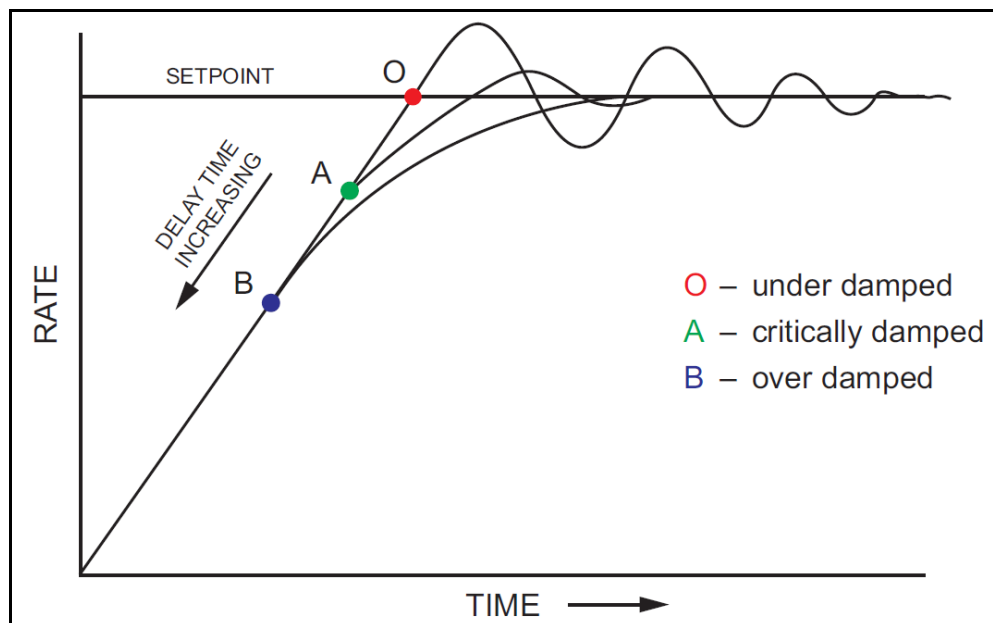

## 7.6 Control Loop Tuning Procedure

This section will help in adjusting SQC-310 PID control loop settings to achieve a stable deposition process. Control loop tuning is a trial and error process and there is no "best" procedure to accomplish this task. It may take several adjustments to achieve the desired tune. This section, assumes an understanding of [Chapter 3, Operation](#) and proper setup of SQC-310 as described in [Chapter 2, Installation](#).

### 1 Set System Parameters

In the **System Menu**:

- ◆ Set Measurement Period to 0.25.
- ◆ Set Rate Filter Alpha to 1 (no filtering) to see the noise of the system.
- ◆ Set System Tooling to 100%.
- ◆ Confirm Simulate Mode is Off.

### 2 Create a One-Layer Test Process

In the **Film Menu**:

- ◆ Create a new film.
- ◆ Enter the Zfactor (Z-Ratio) and the material Density.
- ◆ Set Film Tooling to 100%.

In the **Process Menu**:

- ◆ Create a new process that has the new film as its only layer.
- ◆ Set Init Rate to the desired rate.
- ◆ Set Final Thickness to a large value to prevent the layer from completing.
- ◆ Select the proper Sensor(s) and Source.
- ◆ Leave the other layer parameters at the default values.

### 3 Test the Setup

In the **Sensor Info. Menu**:

- ◆ Verify the Sensor Status is On and a stable frequency is displayed.

### 4 Using the SQC-310 Comm software, Activate data Logging.

**NOTE:** This step is optional. It is helpful for troubleshooting if there are any issues while tuning the control loop.

### 5 Exit to the main screen and press **Next Menu** until the **Auto/Manual** button is displayed. Press **Auto/Manual** to enter Manual mode, then press **Start Layer**.

- 6 Slowly rotate the control knob to a power of 10%, and verify that the power supply output is about 10% of full scale. Continue to slowly rotate the control knob until a rate near the desired setpoint is achieved.
  - ♦ Verify that the power supply output agrees with the SQC-310 Power (%) reading. If the readings are not the same, check the wiring and verify the source setup in the **System** menu. Confirm the Voltage Scale agrees with the input specifications of the power supply.
- 7 With the power set so the rate is near the desired rate (Init Rate in the **Quick Edit** menu), Press **Next Menu** then **Next Graph** until the Rate Deviation graph is displayed, and observe the noise.
  - ♦ If the system has significant short term noise at fixed power (approximately >10%), the control loop will be very difficult to adjust, especially at low rates. It is better to eliminate the source of the noise before attempting to set the PID values ( see [section 6.1, Troubleshooting, on page 6-1.](#))

## 8 Select a new Filter Alpha

On the **Quick Edit Menu**:

- ♦ Slowly decrease the filter Alpha from 1 to a lower value until the rate display noise is minimized. If the Filter Alpha is set too low, the display will lag the true system response and may hide significant problems. A value of 0.5 equally weights the current reading and the previous filtered readings.

## 9 Determine Max Power

- ♦ With the desired rate at a stable reading, record the power (%) ( $PWR_{DR}$ ) value. Set the Max Power (%) to a value 20% higher than this value.

## 10 Determine Open Loop Gain

- ♦ With the power (%) at the desired rate ( $PWR_{DR}$ ) recorded, slowly lower the power(%) until the Rate ( $\text{\AA}/s$ ) reading is just at (or near) zero. Record the zero rate Power reading ( $PWR_{0R}$ ) or P-Term parameter.

## 11 Determine Open Loop Response Time

- ♦ Calculate 1/3 of the desired rate ( $RATE_{1/3}$ ), and 2/3 of the desired rate ( $RATE_{2/3}$ ) for this film.
- ♦ Slowly increase the power (%) until Rate ( $\text{\AA}/s$ ) matches  $RATE_{1/3}$ .
- ♦ Quickly adjust Power (%) to  $PWR_{DR}$ . Measure the time for the Rate ( $\text{\AA}/s$ ) reading to reach  $RATE_{2/3}$ .

**NOTE:** This may need to be done several times to get an average response time. Displaying the Rate graph will also help.

- ♦ Twice the measured time is the step response time ( $TIME_{SR}$ ) or the I-Term parameter.

**NOTE:**  $TIME_{SR}$  is typically 0.2 to 1 seconds for e-beam evaporation, 5 to 20 seconds for thermal evaporation.

- ◆ When finished, slowly decrease power until there is no rate.

## 12 Determine the Dead Time

- ◆ Slowly increase the power (%) until the desired Rate ( $\text{\AA}/s$ ) is achieved.
- ◆ Quickly adjust Power by 1 to 2% and measure the time between when the power is changed and when a change in rate is observed.
- ◆ The time between the change in power and when the rate starts to change is the Dead time or D-Term parameter.

**NOTE:** It is common for the Dead Time of a fast source, such as an e-beam to be very small and possibly immeasurable. In this case, the Dead Time can be considered to be zero.

- ◆ When finished, slowly decrease power to 0%.

## 13 Finalize Adjustments to PID Values according to control response

- ◆ Set source control from Manual to Auto to activate PID control and observe the power. The power should rise from 0% and stabilize near  $PWR_{DR}$ .
  - ◆ If there is more than 10% overshoot in power or if the curve appears under damped, lower the P-Term. If the time to reach  $PWR_{DR}$  is very slow (over damped), increase the P-Term (see [Figure 7-5](#).)
  - ◆ A lower I-Term will increase response for over damped sources. A higher value may reduce ringing and rate deviations seen with under damped sources (see [Figure 7-5](#).)
  - ◆ The D-Term should not need much adjustment, but if under damped behavior is observed, increase the value. If it appears over damped, decrease the value (see [Figure 7-5](#).)

Figure 7-5 Over/Under damped control curve (from a positive/negative step)

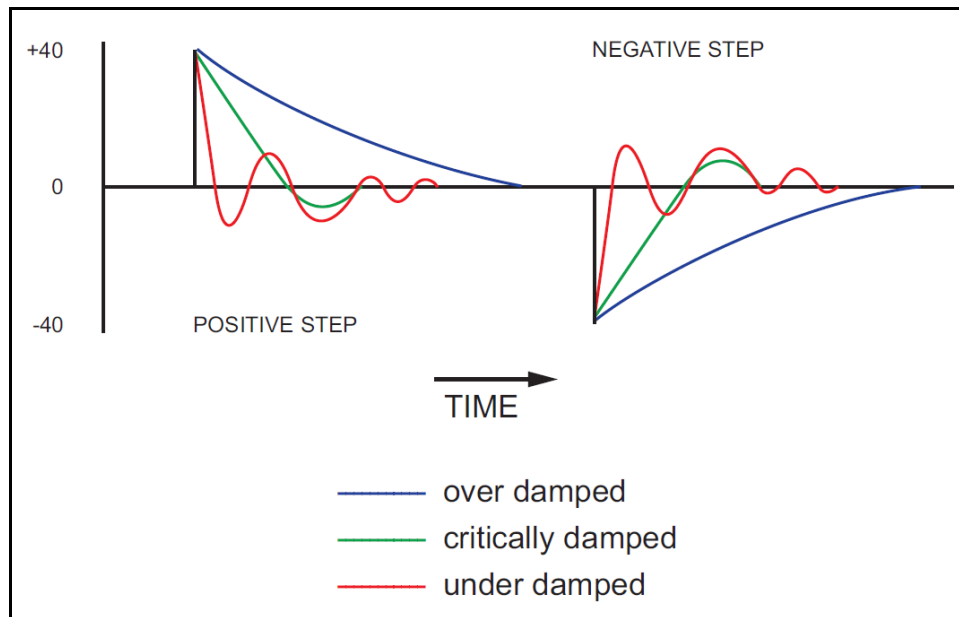

- ◆ Continue to adjust P and I Terms alternating between 0% power in Manual mode and Auto mode until the steady-state response is well controlled. Ringing does not need to be completely removed during this step if the steady-state response is smooth; preconditioning will minimize step changes.
- ◆ When finished, slowly decrease power to 0%, and then press the **Stop** button.

#### 14 Determining Preconditioning Settings

- ◆ The power level recorded as  $PWR_{0R}$  is the power where deposition just begins. Use this value for Ramp 1 power in the **Film Conds** menu. Use a ramp 1 time appropriate for conditioning the source type. For Ramp 2 Power, use a power value that is slightly less than  $PWR_{DR}$ . This will prevent a large step change when entering the deposition phase.

Once PID terms are established for a material, they will typically be similar for other materials given the same system. Only the P-Term and preconditioning power levels may need adjustment. For best results, repeat the control loop tuning for each new material.

If adjustment to the P-Term is not sufficient for limiting response, Slew Rate can further limit aggressive power changes. Slew rate is Power (%) of full scale per second. At rates below 10 Å/s, a slew rate of 1-2% per second is common for e-beam systems. Decreasing the Filter Alpha will also limit the PID control loop response to occasional large noise spikes, such as those seen from arcing.



## Chapter 8

# Measurement Theory

### 8.1 Basics

The quartz crystal deposition monitor, or QCM, utilizes the piezoelectric sensitivity of a quartz monitor crystal to added mass. The QCM uses this mass sensitivity to control the deposition rate and final thickness of a vacuum deposition.

When a voltage is applied across the faces of a properly shaped piezoelectric crystal, the crystal is distorted and changes shape in proportion to the applied voltage. At certain discrete frequencies of applied voltage, a condition of very sharp electro-mechanical resonance is encountered.

When mass is added to the face of a resonating quartz crystal, the frequency of these resonances is reduced. This change in frequency is very repeatable and is precisely understood for specific oscillating modes of quartz. This heuristically easy-to-understand phenomenon is the basis of an indispensable measurement and process control tool that can easily detect the addition of less than an atomic layer of an adhered foreign material.

In the late 1950s it was noted by Sauerbrey<sup>1,2</sup> and Lostis<sup>3</sup> that the change in frequency,  $\Delta F = F_q - F_c$ , of a quartz crystal with coated (or composite) and uncoated frequencies,  $F_c$  and  $F_q$  respectively, is related to the change in mass from the added material,  $M_f$ , as follows:

$$\frac{M_f}{M_q} = \frac{(\Delta F)}{F_q} \quad [1]$$

where  $M_q$  is the mass of the uncoated quartz crystal. Simple substitutions lead to the equation that was used with the first frequency measurement instruments:

$$T_f = \frac{K(\Delta F)}{d_f} \quad [2]$$

where the film thickness,  $T_f$ , is proportional (through  $K$ ) to the frequency change,  $\Delta F$ , and inversely proportional to the density of the film,  $d_f$ . The constant,  $K = N_{at}d_q/F_q^2$ ; where  $d_q (= 2.649 \text{ g/cm}^3)$  is the density of single crystal quartz and  $N_{at} (= 166100 \text{ Hz cm})$  is the frequency constant of AT cut quartz. A crystal with a starting frequency of 6.0 MHz will display a reduction of its frequency by 2.27 Hz when 1 angstrom of Aluminum (density of  $2.77 \text{ g/cm}^3$ ) is added to its surface. In

1. G. Z. Sauerbrey, Phys. Verhand .8, 193 (1957)
2. G. Z. Sauerbrey, Z. Phys. 155,206 (1959)
3. P. Lostis, Rev. Opt. 38,1 (1959)

this manner the thickness of a rigid adlayer is inferred from the precise measurement of the crystal frequency shift. The quantitative knowledge of this effect provides a means of determining how much material is being deposited on a substrate in a vacuum system, a measurement that was not convenient or practical prior to this understanding.

### 8.1.1 Monitor Crystals

No matter how sophisticated the electronics surrounding it, the essential device of the deposition monitor is the quartz crystal. The quartz resonator displayed in [Figure 8-1](#) has a frequency response spectrum that is schematically displayed in [Figure 8-2](#). The ordinate represents the magnitude of response, or current flow of the crystal, at the specified frequency.

Figure 8-1 Quartz resonator

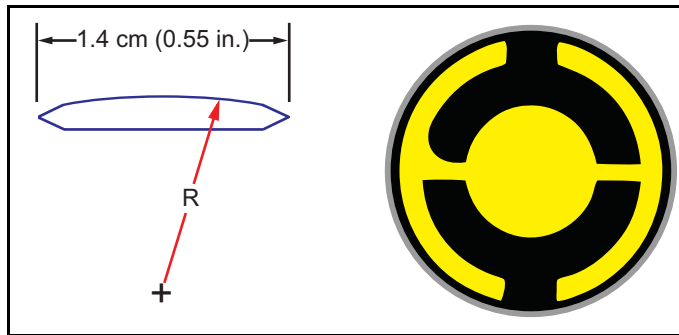

The lowest frequency response is primarily a thickness shear mode that is called the fundamental. The characteristic movement of the thickness shear mode is for displacement to take place parallel to the major monitor crystal faces. In other words, the faces are displacement antinodes as displayed in [Figure 8-3](#).

The responses located slightly higher in frequency are called anharmonics; they are a combination of the thickness shear and thickness twist modes. The response at about three times the frequency of the fundamental is called the third quasiharmonic. There is also a series of anharmonics slightly higher in frequency associated with the quasiharmonic.

The monitor crystal design depicted in [Figure 8-1](#) is the result of several significant improvements from the square crystals with fully electroded plane parallel faces that were first used.

The first improvement was to use circular crystals. This increased symmetry greatly reduced the number of allowed vibrational modes. The second set of improvements was to contour one face of the crystal and to reduce the size of the exciting electrode. These improvements have the effect of trapping the acoustic energy. Reducing the electrode diameter limits the excitation to the central area.

Contouring dissipates the energy of the traveling acoustic wave before it reaches the edge of the crystal. Energy is not reflected back to the center where it can interfere with other newly launched waves, essentially making a small crystal appear to behave as though it is infinite in extent. With the crystal vibrations restricted to the center, it is practical to clamp the outer edges of the crystal to a holder and not produce any undesirable effects.

Contouring also reduces the intensity of response of the generally unwanted anharmonic modes; hence, the potential for an oscillator to sustain an unwanted oscillation is substantially reduced.

Figure 8-2 Frequency response spectrum

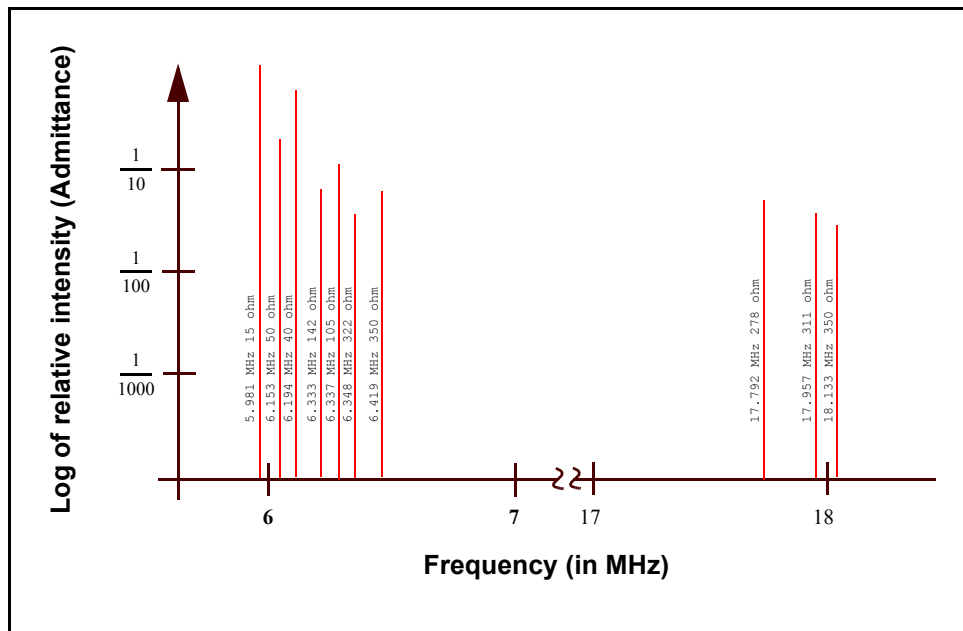

The use of an adhesion layer has improved the electrode-to-quartz bonding, reducing rate spikes caused by micro-tears between the electrode and the quartz as film stress rises. These micro-tears leave portions of the deposited film unattached and therefore unable to participate in the oscillation. These free portions are no longer detected and the wrong thickness consequently inferred.

The AT resonator is usually chosen for deposition monitoring because at room temperature it can be made to exhibit a very small frequency change due to temperature changes. Since there is presently no way to separate the frequency change caused by added mass (which is negative) or even the frequency changes caused by temperature gradients across the crystal or film induced stresses, it is essential to minimize these temperature-induced changes. It is only in this way that small changes in mass can be measured accurately.

PN 074-550-P1E

Figure 8-3 Thickness shear displacement

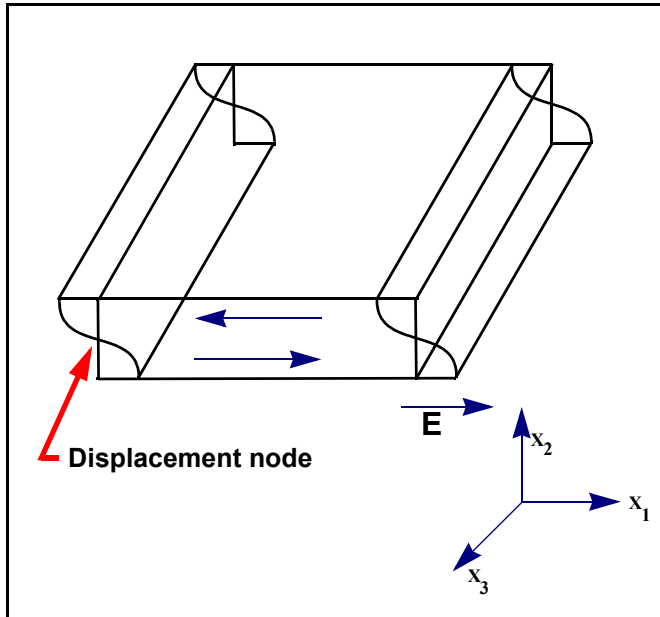

### 8.1.2 Period Measurement Technique

Although instruments using equation [2] were very useful, it was soon noted they had a very limited range of accuracy, typically holding accuracy for  $\Delta F$  less than  $0.02 F_q$ . In 1961, it was recognized by Behrndt<sup>4</sup> that:

$$\frac{M_f}{M_q} = \frac{(T_c - T_q)}{T_q} = \frac{(\Delta F)}{F_c} \quad [3]$$

where  $T_c$  and  $T_q$  are the periods of oscillation of the crystal with film (composite) and the bare crystal respectively.

The period measurement technique was the outgrowth of two factors; first, the digital implementation of time measurement, and second, the recognition of the mathematically rigorous formulation of the proportionality between the crystal thickness,  $I_q$ , and the period of oscillation,  $T_q = 1/F_q$ .

Electronically, the period measurement technique uses a second crystal oscillator, or reference oscillator, not affected by the deposition and usually much higher in frequency than the monitor crystal. This reference oscillator is used to generate small precision time intervals which are used to determine the oscillation period of the monitor crystal. This is done by using two pulse accumulators. The first is used to accumulate a fixed number of cycles,  $m$ , of the monitor crystal. The second is turned on at the same time and accumulates cycles from the reference oscillator until  $m$  counts are accumulated in the first.

4. K. H. Behrndt, J. Vac. Sci. Technol. 8, 622 (1961)

Since the frequency of the reference is stable and known, the time to accumulate the  $m$  counts is known to an accuracy equal to  $\pm 2/F_r$  where  $F_r$  is the reference oscillator frequency. The monitor crystal period is  $(n/F_r)/m$  where  $n$  is the number of counts in the second accumulator. The precision of the measurement is determined by the speed of the reference clock and the length of the gate time (which is set by the size of  $m$ ). Increasing one or both of these leads to improved measurement precision. Having a high frequency reference oscillator is important for rapid measurements (which require short gating times), low deposition rates and low density materials.

### 8.1.3 Z-Match Technique

After learning of fundamental work by Miller and Bolef<sup>5</sup>, which rigorously treated the resonating quartz and deposited film system as a one-dimensional continuous acoustic resonator, Lu and Lewis<sup>6</sup> developed the simplifying Z-Match™ equation in 1972. Advances in electronics taking place at the same time, namely the micro-processor, made it practical to solve the Z-Match equation in “real-time.” Most deposition process controllers sold today use this sophisticated equation that takes into account the acoustic properties of the resonating quartz and film system as shown in equation [4].

$$T_f = \left( \frac{N_{at}d_q}{\pi d_f F_c Z} \right) \arctan \left( Z \tan \left[ \frac{\pi(F_q - F_c)}{F_q} \right] \right) \quad [4]$$

where  $Z=(d_q u_q/d_f u_f)^{1/2}$  is the acoustic impedance ratio and  $u_q$  and  $u_f$  are the shear moduli of the quartz and film, respectively. Finally, there was a fundamental understanding of the frequency-to-thickness conversion that could yield theoretically correct results in a time frame that was practical for process control. To achieve this new level of accuracy requires only that the user enter an additional material parameter,  $Z$ , for the film being deposited. This equation has been tested for a number of materials, and has been found to be valid for frequency shifts equivalent to  $F_f = 0.4F_q$ . Keep in mind that equation [2] was valid to only  $0.02F_q$  and equation [3] was valid only to  $\sim 0.05F_q$ .

5. J. G. Miller and D. I. Bolef, J. Appl. Phys. 39, 5815, 4589 (1968)

6. C. Lu and O. Lewis, J Appl. Phys. 43, 4385 (1972)

# Appendix A

## Material Table

### A.1 Introduction

The following [Table A-1](#) represents the density and Z-Ratio for various materials. The list is alphabetical by chemical formula.



#### CAUTION

**Some of these materials are toxic. Please consult the material safety data sheet and safety instructions before use.**

An \* is used to indicate that a Z-Ratio has not been established for a certain material. A value of 1.000 is defaulted in these situations.

Table A-1 Material Table

Formula	Density	Z-Ratio	Material Name
Ag	10.500	0.529	silver
AgBr	6.470	1.180	silver bromide
AgCl	5.560	1.320	silver chloride
Al	2.700	1.080	aluminum
Al <sub>2</sub> O <sub>3</sub>	3.970	0.336	aluminum oxide
Al <sub>4</sub> C <sub>3</sub>	2.360	*1.000	aluminum carbide
AlF <sub>3</sub>	3.070	*1.000	aluminum fluoride
AlN	3.260	*1.000	aluminum nitride
AlSb	4.360	0.743	aluminum antimonide
As	5.730	0.966	arsenic
As <sub>2</sub> Se <sub>3</sub>	4.750	*1.000	arsenic selenide
Au	19.300	0.381	gold
B	2.370	0.389	boron
B <sub>2</sub> O <sub>3</sub>	1.820	*1.000	boron oxide
B <sub>4</sub> C	2.370	*1.000	boron carbide
BN	1.860	*1.000	boron nitride
Ba	3.500	2.100	barium
BaF <sub>2</sub>	4.886	0.793	barium fluoride

Table A-1 Material Table (continued)

Formula	Density	Z-Ratio	Material Name
Ba <sub>N</sub> 2O <sub>6</sub>	3.244	1.261	barium nitrate
BaO	5.720	*1.000	barium oxide
BaTiO <sub>3</sub>	5.999	0.464	barium titanate (tetr)
BaTiO <sub>3</sub>	6.035	0.412	barium titanate (cubic)
Be	1.850	0.543	beryllium
BeF <sub>2</sub>	1.990	*1.000	beryllium fluoride
BeO	3.010	*1.000	beryllium oxide
Bi	9.800	0.790	bismuth
Bi <sub>2</sub> O <sub>3</sub>	8.900	*1.000	bismuth oxide
Bi <sub>2</sub> S <sub>3</sub>	7.390	*1.000	bismuth trisulfide
Bi <sub>2</sub> Se <sub>3</sub>	6.820	*1.000	bismuth selenide
Bi <sub>2</sub> Te <sub>3</sub>	7.700	*1.000	bismuth telluride
BiF <sub>3</sub>	5.320	*1.000	bismuth fluoride
C	2.250	3.260	carbon (graphite)
C	3.520	0.220	carbon (diamond)
C <sub>8</sub> H <sub>8</sub>	1.100	*1.000	parlyene (union carbide)
Ca	1.550	2.620	calcium
CaF <sub>2</sub>	3.180	0.775	calcium fluoride
CaO	3.350	*1.000	calcium oxide
CaO-SiO <sub>2</sub>	2.900	*1.000	calcium silicate (3)
CaSO <sub>4</sub>	2.962	0.955	calcium sulfat
CaTiO <sub>3</sub>	4.100	*1.000	calcium titanate
CaWO <sub>4</sub>	6.060	*1.000	calcium tungstate
Cd	8.640	0.682	cadmium
CdF <sub>2</sub>	6.640	*1.000	cadmium fluoride
CdO	8.150	*1.000	cadmium oxide
CdS	4.830	1.020	cadmium sulfide
CdSe	5.810	*1.000	cadmium selenide,
CdTe	6.200	0.980	cadmium telluride
Ce	6.780	*1.000	cerium
CeF <sub>3</sub>	6.160	*1.000	cerium (iii) fluoride
CeO <sub>2</sub>	7.130	*1.000	cerium (iv) dioxide
Co	8.900	0.343	cobalt

Table A-1 Material Table (continued)

<b>Formula</b>	<b>Density</b>	<b>Z-Ratio</b>	<b>Material Name</b>
CoO	6.440	0.412	cobalt oxide
Cr	7.200	0.305	chromium
Cr <sub>2</sub> O <sub>3</sub>	5.210	*1.000	chromium (iii) oxide
Cr <sub>3</sub> C <sub>2</sub>	6.680	*1.000	chromium carbide
CrB	6.170	*1.000	chromium boride
Cs	1.870	*1.000	cesium
Cs <sub>2</sub> SO <sub>4</sub>	4.243	1.212	cesium sulfate
CsBr	4.456	1.410	cesium bromide
CsCl	3.988	1.399	cesium chloride
CsI	4.516	1.542	cesium iodide
Cu	8.930	0.437	copper
Cu <sub>2</sub> O	6.000	*1.000	copper oxide
Cu <sub>2</sub> S	5.600	0.690	copper (i) sulfide (alpha)
Cu <sub>2</sub> S	5.800	0.670	copper (i) sulfide (beta)
CuS	4.600	0.820	copper (ii) sulfide
Dy	8.550	0.600	dysprosium
DY <sub>2</sub> O <sub>3</sub>	7.810	*1.000	dysprosium oxide
Er	9.050	0.740	erbium
Er <sub>2</sub> O <sub>3</sub>	8.640	*1.000	erbium oxide
Eu	5.260	*1.000	europium
EuF <sub>2</sub>	6.500	*1.000	europium fluoride
Fe	7.860	0.349	iron
Fe <sub>2</sub> O <sub>3</sub>	5.240	*1.000	iron oxide
FeO	5.700	*1.000	iron oxide
FeS	4.840	*1.000	iron sulfide
Ga	5.930	0.593	gallium
Ga <sub>2</sub> O <sub>3</sub>	5.880	*1.000	gallium oxide (b)
GaAs	5.310	1.590	gallium arsenide
GaN	6.100	*1.000	gallium nitride
GaP	4.100	*1.000	gallium phosphide
GaSb	5.600	*1.000	gallium antimonide
Gd	7.890	0.670	gadolinium
Gd <sub>2</sub> O <sub>3</sub>	7.410	*1.000	gadolinium oxide



Table A-1 Material Table (continued)

<b>Formula</b>	<b>Density</b>	<b>Z-Ratio</b>	<b>Material Name</b>
Ge	5.350	0.516	germanium
Ge <sub>3</sub> N <sub>2</sub>	5.200	*1.000	germanium nitride
GeO <sub>2</sub>	6.240	*1.000	germanium oxide
GeTe	6.200	*1.000	germanium telluride
Hf	13.090	0.360	hafnium
HfB <sub>2</sub>	10.500	*1.000	hafnium boride
HfC	12.200	*1.000	hafnium carbide
HfN	13.800	*1.000	hafnium nitride
HfO <sub>2</sub>	9.680	*1.000	hafnium oxide
HfSi <sub>2</sub>	7.200	*1.000	hafnium silicide
Hg	13.460	0.740	mercury
Ho	8.800	0.580	holmium
Ho <sub>2</sub> O <sub>3</sub>	8.410	*1.000	holmium oxide
In	7.300	0.841	indium
In <sub>2</sub> O <sub>3</sub>	7.180	*1.000	indium sesquioxide
In <sub>2</sub> Se <sub>3</sub>	5.700	*1.000	indium selenide
In <sub>2</sub> Te <sub>3</sub>	5.800	*1.000	indium telluride
InAs	5.700	*1.000	indium arsenide
InP	4.800	*1.000	indium phosphide
InSb	5.760	0.769	indium antimonide
Ir	22.400	0.129	iridium
K	0.860	10.189	potassium
KBr	2.750	1.893	potassium bromide
KCl	1.980	2.050	potassium chloride
KF	2.480	*1.000	potassium fluoride
KI	3.128	2.077	potassium iodide
La	6.170	0.920	lanthanum
La <sub>2</sub> O <sub>3</sub>	6.510	*1.000	lanthanum oxide
LaB <sub>6</sub>	2.610	*1.000	lanthanum boride
LaF <sub>3</sub>	5.940	*1.000	lanthanum fluoride
Li	0.530	5.900	lithium
LiBr	3.470	1.230	lithium bromide
LiF	2.638	0.778	lithium fluoride

Table A-1 Material Table (continued)

<b>Formula</b>	<b>Density</b>	<b>Z-Ratio</b>	<b>Material Name</b>
LiNbO <sub>3</sub>	4.700	0.463	lithium niobate
Lu	9.840	*1.000	lutetium
Mg	1.740	1.610	magnesium
MgAl <sub>2</sub> O <sub>4</sub>	3.600	*1.000	magnesium aluminate
MgAl <sub>2</sub> O <sub>6</sub>	8.000	*1.000	spinel
MgF <sub>2</sub>	3.180	0.637	magnesium fluoride
MgO	3.580	0.411	magnesium oxide
Mn	7.200	0.377	manganese
MnO	5.390	0.467	manganese oxide
MnS	3.990	0.940	manganese (ii) sulfide
Mo	10.200	0.257	molybdenum
Mo <sub>2</sub> C	9.180	*1.000	molybdenum carbide
MoB <sub>2</sub>	7.120	*1.000	molybdenum boride
MoO <sub>3</sub>	4.700	*1.000	molybdenum trioxide
MoS <sub>2</sub>	4.800	*1.000	molybdenum disulfide
Na	0.970	4.800	sodium
Na <sub>3</sub> AlF <sub>6</sub>	2.900	*1.000	cryolite
Na <sub>5</sub> Al <sub>3</sub> F <sub>14</sub>	2.900	*1.000	chiolite
NaBr	3.200	*1.000	sodium bromide
NaCl	2.170	1.570	sodium chloride
NaClO <sub>3</sub>	2.164	1.565	sodium chlorate
NaF	2.558	1.645	sodium fluoride
NaNO <sub>3</sub>	2.270	1.194	sodium nitrate
Nb	8.578	0.492	niobium (columbium)
Nb <sub>2</sub> O <sub>3</sub>	7.500	*1.000	niobium trioxide
Nb <sub>2</sub> O <sub>5</sub>	4.470	*1.000	niobium (v) oxide
NbB <sub>2</sub>	6.970	*1.000	niobium boride
NbC	7.820	*1.000	niobium carbide
NbN	8.400	*1.000	niobium nitride
Nd	7.000	*1.000	neodymium
Nd <sub>2</sub> O <sub>3</sub>	7.240	*1.000	neodymium oxide
NdF <sub>3</sub>	6.506	*1.000	neodymium fluoride
Ni	8.910	0.331	nickel

Table A-1 Material Table (continued)

<b>Formula</b>	<b>Density</b>	<b>Z-Ratio</b>	<b>Material Name</b>
NiCr	8.500	*1.000	nichrome
NiCrFe	8.500	*1.000	Inconel
NiFe	8.700	*1.000	permalloy
NiFeMo	8.900	*1.000	supermalloy
NiO	7.450	*1.000	nickel oxide
P <sub>3</sub> N <sub>5</sub>	2.510	*1.000	phosphorus nitride
Pb	11.300	1.130	lead
PbCl <sub>2</sub>	5.850	*1.000	lead chloride
PbF <sub>2</sub>	8.240	0.661	lead fluoride
PbO	9.530	*1.000	lead oxide
PbS	7.500	0.566	lead sulfide
PbSe	8.100	*1.000	lead selenide
PbSnO <sub>3</sub>	8.100	*1.000	lead stannate
PbTe	8.160	0.651	lead telluride
Pd	12.038	0.357	palladium
PdO	8.310	*1.000	palladium oxide
Po	9.400	*1.000	polonium
Pr	6.780	*1.000	praseodymium
Pr <sub>2</sub> O <sub>3</sub>	6.880	*1.000	praseodymium oxide
Pt	21.400	0.245	platinum
PtO <sub>2</sub>	10.200	*1.000	platinum oxide
Ra	5.000	*1.000	radium
Rb	1.530	2.540	rubidium
RbI	3.550	*1.000	rubidium iodide
Re	21.040	0.150	rhenium
Rh	12.410	0.210	rhodium
Ru	12.362	0.182	ruthenium
S <sub>8</sub>	2.070	2.290	sulfur
Sb	6.620	0.768	antimony
Sb <sub>2</sub> O <sub>3</sub>	5.200	*1.000	antimony trioxide
Sb <sub>2</sub> S <sub>3</sub>	4.640	*1.000	antimony trisulfide
Sc	3.000	0.910	scandium
Sc <sub>2</sub> O <sub>3</sub>	3.860	*1.000	scandium oxide

Table A-1 Material Table (continued)

<b>Formula</b>	<b>Density</b>	<b>Z-Ratio</b>	<b>Material Name</b>
Se	4.810	0.864	selenium
Si	2.320	0.712	silicon
Si <sub>3</sub> N <sub>4</sub>	3.440	*1.000	silicon nitride
SiC	3.220	*1.000	silicon carbide
SiO	2.130	0.870	silicon (ii) oxide
SiO <sub>2</sub>	2.648	1.000	silicon dioxide
Sm	7.540	0.890	samarium
Sm <sub>2</sub> O <sub>3</sub>	7.430	*1.000	samarium oxide
Sn	7.300	0.724	tin
SnO <sub>2</sub>	6.950	*1.000	tin oxide
SnS	5.080	*1.000	tin sulfide
SnSe	6.180	*1.000	tin selenide
SnTe	6.440	*1.000	tin telluride
Sr	2.600	*1.000	strontium
SrF <sub>2</sub>	4.277	0.727	strontium fluoride
SrO	4.990	0.517	strontium oxide
Ta	16.600	0.262	tantalum
Ta <sub>2</sub> O <sub>5</sub>	8.200	0.300	tantalum (v) oxide
TaB <sub>2</sub>	11.150	*1.000	tantalum boride
TaC	13.900	*1.000	tantalum carbide
TaN	16.300	*1.000	tantalum nitride
Tb	8.270	0.660	terbium
Tc	11.500	*1.000	technetium
Te	6.250	0.900	tellurium
TeO <sub>2</sub>	5.990	0.862	tellurium oxide
Th	11.694	0.484	thorium
ThF <sub>4</sub>	6.320	*1.000	thorium (iv) fluoride
ThO <sub>2</sub>	9.860	0.284	thorium dioxide
ThOF <sub>2</sub>	9.100	*1.000	thorium oxyfluoride
Ti	4.500	0.628	titanium
Ti <sub>2</sub> O <sub>3</sub>	4.600	*1.000	titanium sesquioxide
TiB <sub>2</sub>	4.500	*1.000	titanium boride
TiC	4.930	*1.000	titanium carbide

Table A-1 Material Table (continued)

<b>Formula</b>	<b>Density</b>	<b>Z-Ratio</b>	<b>Material Name</b>
TiN	5.430	*1.000	titanium nitride
TiO	4.900	*1.000	titanium oxide
TiO <sub>2</sub>	4.260	0.400	titanium (iv) oxide
Tl	11.850	1.550	thallium
TlBr	7.560	*1.000	thallium bromide
TlCl	7.000	*1.000	thallium chloride
TlI	7.090	*1.000	thallium iodide (b)
U	19.050	0.238	uranium
U <sub>3</sub> O <sub>8</sub>	8.300	*1.000	tri uranium octoxide
U <sub>4</sub> O <sub>9</sub>	10.969	0.348	uranium oxide
UO <sub>2</sub>	10.970	0.286	uranium dioxide
V	5.960	0.530	vanadium
V <sub>2</sub> O <sub>5</sub>	3.360	*1.000	vanadium pentoxide
VB <sub>2</sub>	5.100	*1.000	vanadium boride
VC	5.770	*1.000	vanadium carbide
VN	6.130	*1.000	vanadium nitride
VO <sub>2</sub>	4.340	*1.000	vanadium dioxide
W	19.300	0.163	tungsten
WB <sub>2</sub>	10.770	*1.000	tungsten boride
WC	15.600	0.151	tungsten carbide
WO <sub>3</sub>	7.160	*1.000	tungsten trioxide
WS <sub>2</sub>	7.500	*1.000	tungsten disulfide
WSi <sub>2</sub>	9.400	*1.000	tungsten silicide
Y	4.340	0.835	yttrium
Y <sub>2</sub> O <sub>3</sub>	5.010	*1.000	yttrium oxide
Yb	6.980	1.130	ytterbium
Yb <sub>2</sub> O <sub>3</sub>	9.170	*1.000	ytterbium oxide
Zn	7.040	0.514	zinc
Zn <sub>3</sub> Sb <sub>2</sub>	6.300	*1.000	zinc antimonide
ZnF <sub>2</sub>	4.950	*1.000	zinc fluoride
ZnO	5.610	0.556	zinc oxide
ZnS	4.090	0.775	zinc sulfide
ZnSe	5.260	0.722	zinc selenide

Table A-1 Material Table (continued)

<b>Formula</b>	<b>Density</b>	<b>Z-Ratio</b>	<b>Material Name</b>
ZnTe	6.340	0.770	zinc telluride
Zr	6.490	0.600	zirconium
ZrB <sub>2</sub>	6.080	*1.000	zirconium boride
ZrC	6.730	0.264	zirconium carbide
ZrN	7.090	*1.000	zirconium nitride
ZrO <sub>2</sub>	5.600	*1.000	zirconium oxide





[www.inficon.com](http://www.inficon.com)    [reachus@inficon.com](mailto:reachus@inficon.com)

Due to our continuing program of product improvements, specifications are subject to change without notice.  
All trademarks are the property of their respective owners.

PN 074-550-P1E    © 2016 INFICON