





Operating Manual
Incl. EU Declaration of Conformity

VGC083C

Vacuum Gauge Controller

Product Identification

In all communications with INFICON, please specify the information on the product nameplate:

INFICON AG, LI-9496 Balzers Model:..... PN:..... SN:.....VDC;.....W	 
---	---

Validity

This document applies to products with part number 399-702.
 The part number (PN) can be taken from the product nameplate.

We reserve the right to make technical changes without prior notice.

Important User Information

There are operational characteristic differences between solid state equipment and electromechanical equipment. Because of these differences, and because there are a variety of uses for solid state equipment, all persons that apply this equipment must take every precaution and satisfy themselves that the intended application of this equipment is safe and used in an acceptable manner.

In no event will INFICON be responsible or liable for indirect or consequential damages that result from the use or application of this equipment.

Any examples or diagrams included in this manual are provided solely for illustrative purposes. Because of the many variables and requirements imposed on any particular installation, INFICON cannot assume responsibility or liability for any actual use based on the examples and diagrams.

No patent liability is assumed by INFICON with respect to use of information circuits, equipment, or software described in this manual.

Throughout this manual we use notes, notices and apply internationally recognized symbols and safety messages to make you aware of safety considerations.

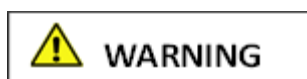

Identifies information about practices or circumstances that can cause electrical or physical hazards which, if precautions are not taken, could result in death or serious injury, property damage, or economic loss.



Identifies information about practices or circumstances that can cause electrical or physical hazards which, if precautions are not taken, could result in minor or moderate injury, property damage, or economic loss.



Identifies information that is critical for successful application and understanding of the product.

**SHOCK HAZARD**

Labels may be located on or inside the device to alert people that dangerous voltages may be present.

Liability and Warranty



INFICON assumes no liability and the warranty is rendered null and void if the end-user or third parties

- disregard the information in this document
- use the product in a non-conforming manner
- make any kind of interventions (modifications, alterations etc.) on the product
- use the product with accessories not listed in the corresponding product documentation.

Contents

Product Identification	2
Validity	2
Important User Information	2
Liability and Warranty	3
1 Introduction / General Information	6
1.1 Description	6
2 Technical Data	7
2.1 VGC083C	7
2.2 Power Supply for VGC083C (Optional)	9
3 Important Safety Information	10
3.1 Safety Precautions - General	10
3.2 Safety Precautions - Service and Operation	10
3.3 Electrical Conditions	11
3.3.1 Proper Equipment Grounding	11
3.3.2 Electrical Interface and Control	11
3.4 Overpressure and use with hazardous gases	11
3.5 Gases other than Nitrogen / air	12
4 Installation	13
4.1 Mechanical Installation - Controller	13
4.1.1 Panel Mount	13
4.1.2 Rack Mount	13
4.1.3 Mechanical Installation - Ionization Gauge	14
4.1.4 Mechanical Installation - Convection Gauge	15
4.2 Electrical Installation	16
4.2.1 Grounding	16
4.2.2 Installation	16
4.2.3 Connecting MAG050 / MAG060 - connector labeled "1"	17
4.2.4 Connecting the PGE050 - connectors labeled "2" and "3"	17
4.2.5 Power Connection	18
4.2.6 Relay Connection	18
4.2.7 Analog Output Connection	18
4.2.8 Analog Input Connection (Capacitance Diaphragm Gauges, etc.)	18
4.2.9 Digital I/O Connection	19
4.2.10 RS232 / RS485 Serial Communications Connection	20
5 Operation - IG and CG	22
5.1 IG Over Pressure Shut Down	22
5.2 Convection Gauge (CG) Initial Setup	22
5.3 Cond Cathode Activation Delay	23
6 Setup and programming	24
6.1 Applying Power	24
6.2 Front Panel Display	24
6.3 User Interface Basics	25
6.4 Factory-Set Default Parameters	25
6.5 Programming	26
6.5.1 SETUP UNIT	27
6.5.2 ION GAUGE	28
6.5.3 CONVEC GAUGE	29
6.5.4 RELAYS	30
6.5.5 Analog Output	32
6.5.6 SERIAL COMM	36
6.5.7 DISPLAY	37
7 Analog Output Charts & Equations (Nitrogen/Air Only)	39
7.1 Analog Output wide range measurement for IG - CG1 0.5 - 7V (Nitrogen / Air only)	39
7.2 Analog Output for IG LOG N - 10 (Nitrogen / Air only)	40
7.3 Analog Output for IG LOG N - 11 (Nitrogen / Air only)	41
7.4 Analog Output for IG LOG N - 12 (Nitrogen / Air only)	42
7.5 Analog Output for IG 1.8 - 8.7 V (Nitrogen / Air only)	43
7.6 Analog Output for IG LINEAR (Nitrogen / Air only)	44
7.7 Analog Output for CG1 or CG2 1 - 8 V (Nitrogen / Air only)	44
7.8 Analog Output for CG1 or CG2 0 - 7 V (Nitrogen / Air only)	46
7.9 Analog Output for CG1 or CG2 NON - LIN (Nitrogen / Air only)	47
7.10 Analog Output for CG1 or CG2 LINEAR (Nitrogen / Air only)	49

8 Using the Gauge with Different Gases	50
8.1 Ion Gauge Display Correction Factors for Selected Gases	50
8.2 Effects of Different Gases on Convection Gauge Display	51
8.3 Effects of Different Gases on Analog Output	55
8.3.1 Ion Gauge Analog Output Correction Factors for Selected Gases	55
8.3.2 IG - CG1 0.5 - 7V Analog Output Correction Factors for Selected Gases	55
8.3.2.1 IG-CG1 0.5 - 7V Analog Output Correction Factors - Ion Gauge Range	56
8.3.2.2 IG-CG1 0.5 - 7V Analog Output Correction Factors - Convection Gauge Range	57
8.3.3 Convection gauge analog output for selected gases	57
8.3.3.1 CG1 1 - 8 V or CG2 1 - 8 V Analog Output Correction Factors - Convection Gauge	58
8.3.3.2 CG1 0 - 7 V or CG2 0 - 7 V Analog Output Correction Factors - Convection Gauge	59
8.3.3.3 CG1 NON-LIN or CG2 NON-LIN Analog Output Correction Factors - Convection Gauge	60
9 Communication Protocol (Serial Interface)	61
9.1 Device Specific Serial Communication Info	61
9.2 INFICON RS232 / RS485 Command Protocol Summary	61
9.3 INFICON RS232 and RS485 Command Protocol Summary	62
9.4 RS232 GP 307 and 358 Protocol	65
9.5 RS485 GP 307 and 358 Protocol	66
10 Service	68
10.1 Calibration	68
10.2 Maintenance	68
10.3 Troubleshooting - Operation	68
10.4 Troubleshooting - Error Messages	69
10.5 Clearing Error Messages	69
10.6 Research Screen	69
10.6.1 Research Screen (Diagnostic Display)	69
10.7 Cleaning the VGC083C	70
11 Repair	70
12 Accessories	70
13 Storage	71
14 Disposal	71
EU Declaration of Conformity	72

For cross-references within this document, the symbol (→  XY) is used; for cross-references to further documents listed under 'Literature', use is made of the symbol (→  [Z]).

1 Introduction / General Information

1.1 Description

The Vacuum Gauge Controller VGC083C is a vacuum pressure measurement system which is comprised of the following:

- The VGC083C Vacuum Gauge Controller
- One INFICON MAG050 or MAG060 passive Cold Cathode Gauge head
- One or two INFICON PGE050 convection enhanced pirani heads¹⁾
- Cables to interconnect the VGC083C and point-of-use devices

¹⁾ The VGC083C will also operate the Granville-Phillips® Convectron® convection enhanced pirani vacuum gauge head.

Typical components of the complete vacuum measurement system are shown in the figure below. The VGC083C provides power and operating control for the MAG050 / 060 hot ion gauge head (IG). Additionally, it provides power and operating control for up to two enhanced convection gauges (CG).

Typical Components of the complete Vacuum Pressure Measurement System



VGC083C Vacuum Gauge Controller



MAG050 or MAG060 passive Cold Cathode Gauge head



PGE050 Convection Gauges 1 & 2 (CVG 1 & 2)

The VGC083C, a controller unit capable of controlling multiple gauge heads, is either rack or instrument panel mountable. Optional industry standard 19-inch, 2U high rack-mount panels are available to mount the unit into rack enclosures. For important information about the PGE050 convection gauge, MAG050 / MAG060 passive Cold Cathode Gauge heads please refer to the Operating Manual for each of this products. Read the Operating Manuals in their entirety for any device you intend to connect to the VGC083C prior to connecting and using the external devices and cables that the VGC083C is intended to be used with.

2 Technical Data

2.1 VGC083C

Measurement range	VGC083C	
	with MAG050 & PGE050	1.5×10 ⁻⁹ ... 1000 Torr
	with MAG060 & PGE050	7.5×10 ⁻¹¹ ... 1000 Torr
	Units of measurement	Torr, mbar, Pa (user selectable)
Display	Pressure indication	LED - 3 independent pressure display channels, 3 digit plus 2 digit exponent per channel
	Programming & set-up screen	OLED - displays state of all setpoint relays, IG emission current, error messages for fault conditions
Functionality	IG 1	powers & operates one INFICON MAG050 or MAG060 passive Cold Cathode Gauge
	CG 2 , 3	powers & operates up to 2 INFICON PGE050 convection or Granville-Phillips® (GP) Convector®
	Alternate gauge	displays pressure from an alternate gauge such as a Capacitance Diaphragm Gauge - CDG or other INFICON gauges using the analog input (external power source for these alternate auxiliary devices will be required)
IG sensor control	IG sensor on/off can all be controlled via front panel soft-keys, remote input signals (digital I/O) or serial communications. IG sensor can also be automatically turned on/off using measurements from one of the user selectable convection or alternate gauges.	
IG remote input signals (digital I/O)	IG sensor on/off can also be set by applying momentary continuity to ground. Also the 9-pin D-sub remote input DIGITAL I/O connector provides pin-pin compatible signals with the GP 358 controller as well as compatible signals with the GP 307.	
Setpoint relays	Number	6 single-pole, double-throw (SPDT), user assignable to any of the gauges
	Contact rating	5 A at 30 V (dc), 5 A at 250 V (ac), resistive load

Analog output	IG analog output	
	Log-linear	0 ... 10 V (dc), 1 V/decade, or ¹⁾ 1.7 ... 9.3 V (dc) (nominal 1.8 ... 8.7 V (dc)), 0.8 V/decade
	Linear	0 ... 10 V (dc) (useable over 3 decades) ²⁾
	Combination IG + CG or IG + ALT analog	
	Log-linear	0.5 ... 7 V (dc), 0.5 V/decade
	CG analog output	
	Log-linear	1 ... 8 V (dc), 1 V/decade ³⁾ , or 0 ... 7 V (dc), 1 V/decade ³⁾
	Linear	0 ... 10 V (dc) (useable over 3 decades)
	Non-linear analog S-curve	0.375 ... 5.659 V (dc)
		¹⁾ Various scaling selections also provide output compatibility with Granville-Phillips® controller models 307, 350 and 358 controllers.
	²⁾ Also compatible with GP 307 controller.	
	³⁾ Also compatible with GP 307, 350 and 358.	
Analog input	CDG	one 0 ... 10 V (dc) analog input signal from a CDG when used as an alternate gauge to CG2
	INFICON	analog input from one of the following gauges: PGE300, PGE500, BAG302
Serial communications	Protocol	RS485 / RS232 - ASCII protocol (command protocol compatibility with GP 307 and GP 358 controller is also provided)
Status output	<p>IG sensor on/off status displayed as pressure reading on the front panel, by serial communications and by SPDT relay (DIGITAL I/O Connector) rated at 1 A at 30 V (dc) resistive, or 1 A at 30 V (ac) non-inductive.</p> <p>IG error conditions are displayed on the front panel, by serial communications and by an open collector transistor output (ground emitter) rated at 40 V max. VCE, 50 mA IC max.</p>	
IG overpressure protection	Turns ion gauge off at 5.00×10^{-3} or overpressure value programmed by the user.	
Ambience	Temperature	
	Operation	0 ... +40 °C
	Storage	-40 ... +70 °C
	Relative humidity	0 ... 95, non-condensing
Altitude	Operating	max. 2500 m (8200 ft.)
	Storage	max. 12500 m (41000 ft.)
Housing	Housing	aluminum extrusion

Mains specifications

Voltage	20 ... 28 V (dc), 12 W protected against power reversal and transient over-voltages
Connectors	gauge cable assemblies provided by INFICON
IG & CG	9-pin D-sub male
Digital I/O	
Serial communications	
RS232	9-pin D-sub female
RS485	9-pin D-sub male
analog I/O, setpoint relays, power	pluggable terminal block (mating connectors included)

Dimensions

mm (inch)

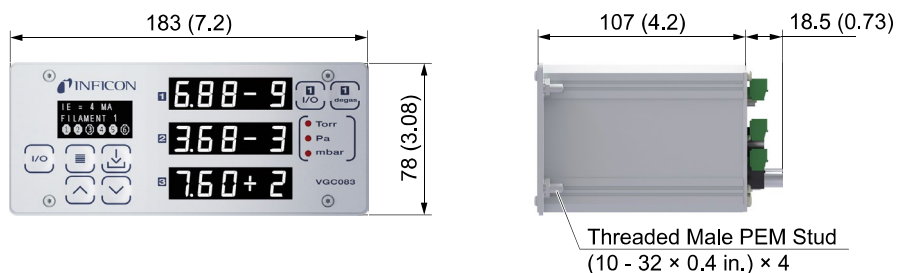

Weight

0.7 kg (1.7 lb.)

2.2 Power Supply for VGC083C (Optional)

Connector	2-pin pluggable terminal block to mate with the VGC083C
Power input	100 ... 240 V (ac), 50 ... 60 Hz
Power output	24 V (dc), 2.5 A (60 W)
Compliance	CE, RoHS, UL (US/Canada), CCC (China)

3 Important Safety Information

INFICON has designed and tested this product to provide safe and reliable service, provided it is installed and operated within the strict safety guidelines provided in this manual. **Please read and follow all warnings and instructions.**



To avoid serious injury or death, follow the safety information in this document. Failure to comply with these safety procedures could result in serious bodily harm, including death, and or property damage.

Failure to comply with these warnings violates the safety standards of installation and intended use of this instrument. INFICON disclaims all liability for the customer's failure to comply with these instructions.

Although every attempt has been made to consider most possible installations, INFICON cannot anticipate every contingency that arises from various installations, operation, or maintenance of the instrument. If you have any questions about the safe installation and use of this product, please contact INFICON.

This device meets FCC part 15 requirements for an unintentional radiator, class A.

3.1 Safety Precautions - General

Hazardous voltages are present with this product during normal operation. The product should never be operated with the covers removed unless equivalent protection of the operator from accidental contact with hazardous internal voltages is provided.

 **WARNING!** There are no operator serviceable parts or adjustments inside the product enclosure. Refer servicing to service trained personnel.

Do not modify this product or substitute any parts without authorization of qualified INFICON service trained personnel. Return the product to an INFICON qualified service and repair center to ensure that all safety features are maintained. Do not use this product if unauthorized modifications have been made.

 **WARNING!** Source power must be removed from the product prior to performing any servicing.

After servicing this product, ensure that all safety checks are made by a qualified service person. When replacement parts are required, ensure that the parts are specified by INFICON. Substitutions of non-qualified parts may result in fire, electric shock or other hazards. Use of unauthorized parts or modifications made to this product will void the warranty.

To reduce the risk of fire or electric shock, do not expose this product to rain or moisture. These products are not waterproof and careful attention must be paid to not spill any type of liquid onto these products. Do not use these products if they have been damaged. Immediately contact INFICON to arrange return of the product if it is damaged.

Due to the possibility of corrosion when used in certain environmental conditions, it is possible that the product's safety could be compromised over time. It is important that the product be periodically inspected for sound electrical connections and equipment grounding. Do not use if the equipment grounding or electrical insulation has been compromised.

3.2 Safety Precautions - Service and Operation

Ensure the enclosure of the unit is connected directly to a good quality earth ground.

Ensure that the vacuum port on which the vacuum gauge sensors are mounted is electrically grounded.

Use a power source of 20 ... 28 V (dc), 12 W or use INFICON series optional power supplies.

Turn off power to the unit before attempting to service the controller.

Turn off power to the unit if a cable or plug is damaged or the product is not operating normally according to this instruction manual. Contact qualified INFICON service personnel for any service or troubleshooting condition that may not be covered by this operating manual.

It is important that the product be periodically inspected for sound electrical connections and equipment grounding. Do not use if the equipment grounding or electrical insulation has been compromised.

Do not use if the unit has been dropped or the enclosure has been damaged. Contact INFICON for return authorization and instructions for returning the product to INFICON for evaluation.

If measured pressure exceeds 5.00×10^{-3} Torr or the value programmed in the "OVER PRESSURE" menu the sensor will turn off.

3.3 Electrical Conditions

 **WARNING!** When high voltage is present in any vacuum system, a life threatening electrical shock hazard may exist unless all exposed electrical conductors are maintained at earth ground potential. This applies to all products that come in contact with the gas contained in vacuum chambers. An electrical discharge within a gaseous environment may couple dangerous high voltage directly to any ungrounded conductor of electricity. A person could be seriously injured or killed by coming in contact with an exposed, ungrounded electrical conductor at high voltage potential. This condition applies to all products that may come in contact with the gas inside the vacuum chamber (vacuum/pressure containment vessel).

3.3.1 Proper Equipment Grounding

 **WARNING!** Hazardous voltages that could seriously injure or cause death are present in many vacuum processes. Verify that the vacuum connection ports on which the ion gauge and the convection gauges are mounted are electrically grounded. Consult a qualified Electrician if you are in doubt about your equipment grounding. Proper grounding of your equipment is essential for safety as well as intended operation of the equipment. The vacuum gauge heads and enclosure of any control module must be connected directly to a good quality equipment earthing conductor. Use a ground lug on the vacuum connection flange of the pressure measurement devices if necessary.

 **WARNING!** In order to protect personnel from electric shock and bodily harm, shield all conductors which are subject to potential high voltage electrical discharges in or around the vacuum system.

3.3.2 Electrical Interface and Control

It is the user's responsibility to ensure that the electrical signals from this product and any connections made to external devices, for example, relays and solenoids, are used in a safe manner. Always double check the system set-up before using any signals to automate your process. Perform a hazardous operation analysis of your system design and ensure safeguards and personnel safety measures are taken to prevent injury and property damage.

3.4 Overpressure and use with hazardous gases

 **WARNING!** Install suitable protective devices that will limit the level of pressure inside your vacuum chamber to less than what the vacuum chamber system components are capable of withstanding.

In cases where an equipment failure could cause a hazardous condition, always implement fail-safe system operation. For example, use a pressure relief device in an automatic backfill operation where a malfunction could result in high internal pressures if the pressure relief device was not installed on the chamber.

The vacuum gauge heads used with this product are not intended for use at pressures above 20 psia (1000 Torr); DO NOT exceed 35 psig (< 2 ½ bars) pressure inside the sensor. The MAG050 / 060 passive cold cathode vacuum gauge heads have an admissible pressure of 130 psi (9 bar absolute - limited to inert gases <55 °C). If your chamber goes to higher pressures than what these heads are rated for, you should install an isolation valve or pressure relief device to protect the gauge tube from overpressure conditions. With some fittings, actual safe overpressure conditions may be lower; for example, a quick-connect, O-ring compression fitting may forcibly release the gauge tube from the vacuum chamber fitting with only a few psi over local uncorrected barometric (atmospheric) pressure.

⚠ CAUTION! If the internal pressure of a vacuum gauge device is allowed to increase above local uncorrected barometric pressure (atmospheric pressure side), vacuum fittings may release and possible overpressure conditions may cause leaks that would allow the gas inside the gauge tube to release into the atmosphere of the surrounding environment. Toxic, pyrophoric and flammable gases are examples of hazardous gases that if allowed to leak out of the vacuum/pressure containment vessel into the atmospheric environment, could cause bodily injury and possible damage to equipment. Never expose the gauge tube internal volume to pressure above local atmospheric pressure when using hazardous gases.

3.5 Gases other than Nitrogen / air

⚠ WARNING! Do not attempt to use with gases other than nitrogen (N₂) or air without referring to correction factor data tables.

INFICON gauges and modules are calibrated for direct readout of nitrogen or air. Do not attempt to use with other gases such as argon (Ar) or carbon dioxide (CO₂) unless you have applied correction factors to both the displayed pressure and the analog output to determine the true measured pressure. This is particularly critical when using convection gauges to measure pressure of gases other than N₂/Air.

⚠ WARNING! Do not use the PGE050 in an explosive atmosphere or in the presence of flammable gases, vapors or fumes. Do not use the PGE050 to measure the pressure of explosive or combustible gases or gas mixtures. The sensor wire in the gauge normally operates at 125 °C, but if malfunction should occur, the wire temperature could exceed the ignition temperature of certain combustible gases and gas mixture. This could cause an explosion which could result in serious injury or death.

4 Installation

4.1 Mechanical Installation - Controller

The unit is intended for indoor use only. The unit is offered as a space saving half rack design. It may also be used as a bench top device or easily installed in an instrument panel. Optional EIA-standard rack mount panels are available for either full rack or dual, side-by-side rack mount installation.

4.1.1 Panel Mount

Procedure

- 1 Make a cutout in your rack panel or instrument control panel as shown in the drawing below. Be sure to allow clearance behind the panel for the instrument as well as connectors and cables at the back of the instrument. Optional EIA-standard, 19-inch, 2U height rack mount panels are available from INFICON. The optional rack mount panels are provided with panel cut-outs and mounting holes to allow efficient mounting of your VGC083C unit.

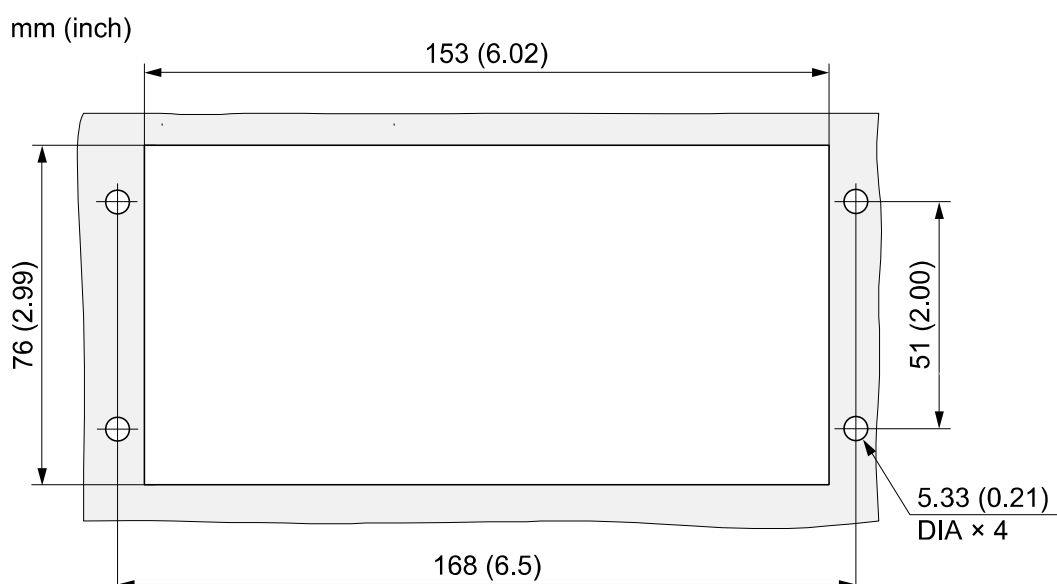

- 2 Drill four guide holes on each side of the panel cut out (two on each side) with dimensions as shown in the panel cut-out drawing above.
- 3 Slide the unit into the panel hole cut-out. Guide the four studs on the back of the unit front panel face plate through the four holes next to the panel cut-out.
- 4 Use four # 10-32 Hex Nut (provided with instrument) to tighten the unit to the panel.

4.1.2 Rack Mount

Optional EIA-standard 19-inch wide, 2U height rack mount panels available from INFICON (→ 70):

Single cut-out panel

All dimensions in inches.

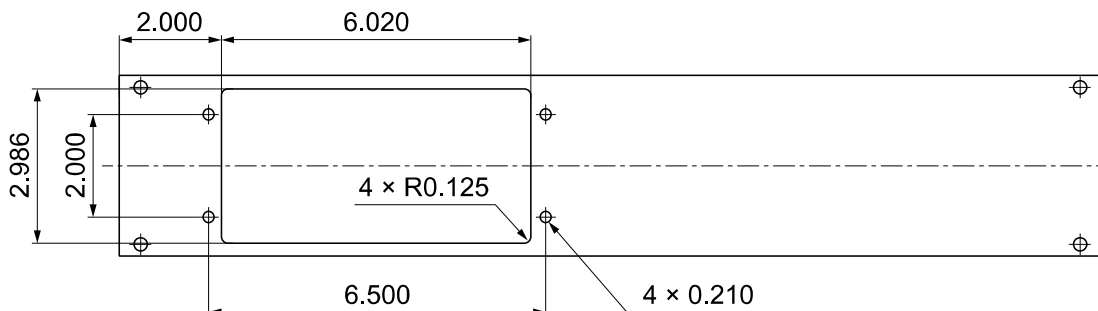

Single cut-out panel

All dimensions in inches.

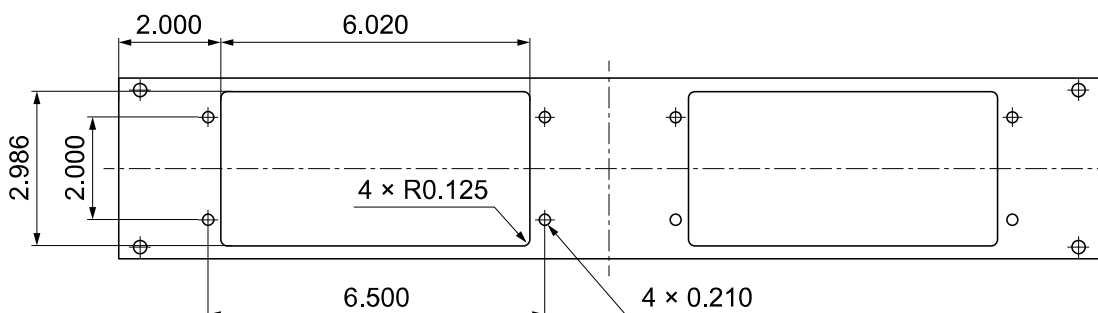

The single cut-out and dual cut-out rack mountable panels shown above are available from INFICON. Panel color matches the front panel of VGC083C units. Screws for mounting to rack enclosure are included.

4.1.3 Mechanical Installation - Ionization Gauge



For more detailed information about the MAG050 / 060 cold cathode ionization gauge, please refer to the Operating Manual for this product.



CAUTION! Dirt and damage can impair the function of the vacuum component. Take appropriate measures to ensure cleanliness and prevent damage. Touching the product or parts with bare hands increases the desorption rate. Always use clean, lint free gloves as well as clean tools when working with this product.

Mount the ionization gauge as close as possible to the pressure you want to measure. Long or restricted, small diameter tubing will create a pressure difference between your process chamber and the gauge. This may cause a delay in response to pressure changes. Mounting the ionization gauge too close to a gas source inlet may also cause measurement and control instability.

The gauge can be mounted in any orientation, however, if possible, mount the gauge with port down to help minimize the effect of any particles or condensation collecting in the gauge.

Do not mount the gauge where it will be subjected to excessive vibration. Vibrations may cause unstable readings, measurement errors and possible mechanical stress to components in the gauge.

For electrical safety purposes the housing of the gauge must be grounded to the vacuum chamber. When using KF flanges, metal clamps must be used to ensure proper grounding. If the gauge may come into contact with charged particles (plasma, ion beam etc.), make sure its vacuum connections is galvanically connected to the vacuum chamber and do always use conductive metallic centering rings and clamps. Do not attempt to modify your flange in order to use non-metallic-type flange clamps.

Use all metal vacuum fittings with metal seals when operating pressures are expected to be below 1.00×10^{-7} Torr (1.33×10^{-7} mbar, 1.33×10^{-5} Pa).

Remove the protective lid and install the product to the vacuum system following manufacturer's recommendations for different flanges and fittings. Keep the protective lid for future maintenance.

4.1.4 Mechanical Installation - Convection Gauge



For more detailed information about the PGE050 convection gauge, please refer to the Operating Manual for this product.

Mount the PGE050 as close as possible to the pressure you want to measure. Long or restricted, small diameter tubing will create a pressure difference between your process chamber and the gauge. This may cause a delay in response to pressure changes.

Mounting the PGE050 too close to a gas source inlet may also cause measurement and control instability. Do not mount the PGE050 near a source of heating or cooling, such as heaters or air conditioning vents.

Mount the PGE050 with its main axis horizontal (see diagram below). Pressure reading errors may occur above 1 Torr if the unit is not mounted horizontally. Below 1 Torr, mounting position has little to no effect.

For Accurate Measurements Above 1 Torr, Mount the Gauge Axis Horizontally as Shown Below

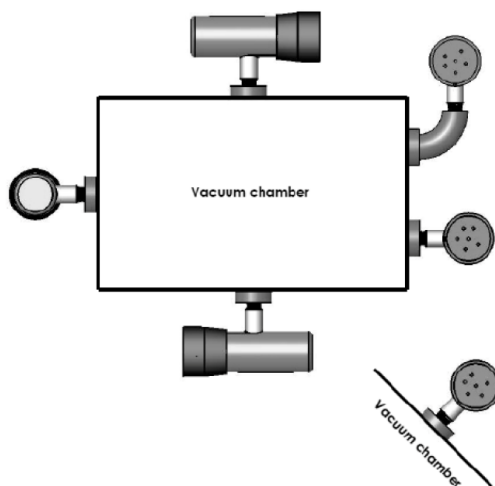

Correct Orientation

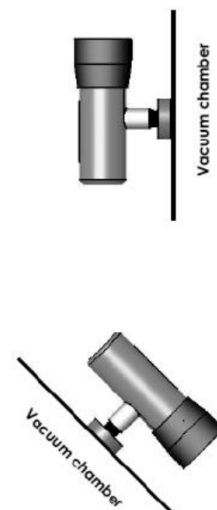

Incorrect Orientation

Mount the PGE050 with port down, if possible, to help minimize the effect of any particles or condensation from collecting in the gauge.

Do not mount the PGE050 where it will be subjected to excessive vibration. Vibrations may cause unstable readings, measurement errors and possible mechanical stress to components in the PGE050.

Flanges/ Fittings - follow the manufacturer's recommendations and note the following:

- NPT fittings: When connecting the device using a NPT fitting, apply a thread sealant compound or wrap the threaded portion of the tubing with one-and-a-half to two wraps of pipe thread seal tape such as PTFE (Teflon®) tape and hand tighten the gauge into the gauge port. Do not use a wrench or other tool which may damage the gauge.

4.2 Electrical Installation

4.2.1 Grounding

⚠ Be sure the vacuum gauges and the rest of your vacuum system are properly grounded to protect personnel from shock and injury. Be aware that some vacuum fittings, especially those with O-rings when not used with metal clamps, may not produce a good electrical connection between the gauge and the chamber it is connected to. Use a ground lug on the vacuum connection flange of the pressure measurement device if necessary. The VGC083C control unit should be connected to earth ground via a good quality equipment earthing conductor. It is encouraged that you connect a separate 12-AWG earthing conductor between a known facility earth ground connection and the location marked with the earth ground symbol (via the green colored screw provided) on the back panel of the VGC083C.

4.2.2 Installation

A good, recommended practice is to remove power from any cable prior to connecting or disconnecting it. The electrical connections for the VGC083C are located on the back panel of the device as shown below.

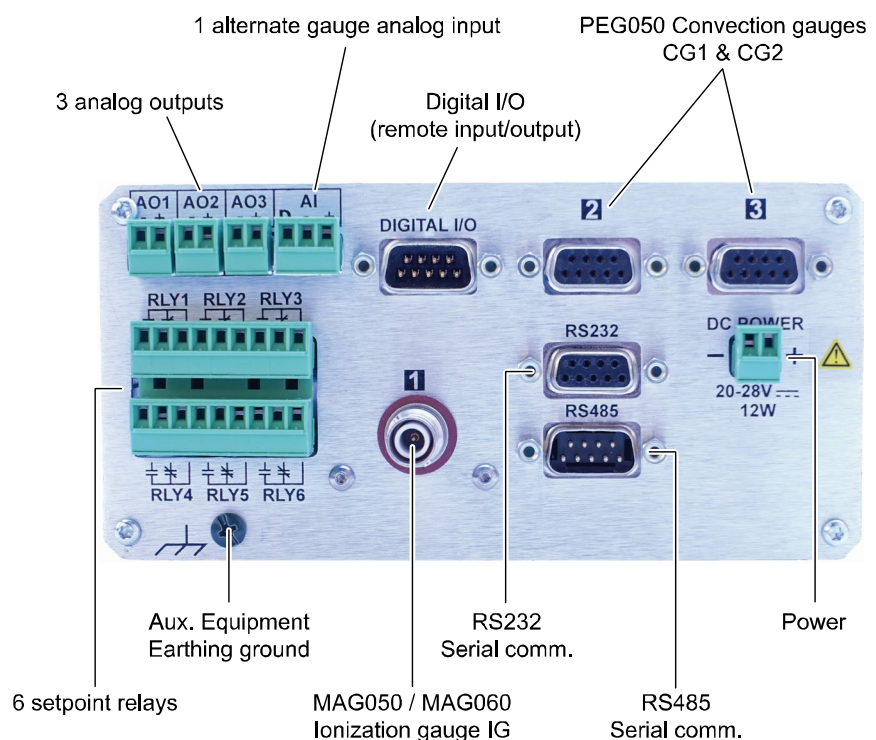

4.2.3 Connecting MAG050 / MAG060 - connector labeled "1"



⚠ CAUTION! It is always good industry practice to turn off power to the instrument before connecting or disconnecting cables.

The custom cable / connector assembly are custom cable assemblies provided in different lengths from INFICON for connecting the VGC083C to the MAG050 / 060 cold cathode ionization gauge sensor.

Changing cables from one device to another when power is applied is not only bad electronics handling procedure, it is not advised and, if done by the user of this equipment, may lead to erroneous measurement results, a hazardous situation, equipment damage and possible operator injury.

Part numbers → [70](#).

MAG050 / MAG060 IG
bakable cable 250 °C



MAG050 / MAG060 IG
80 °C



4.2.4 Connecting the PGE050 - connectors labeled "2" and "3"

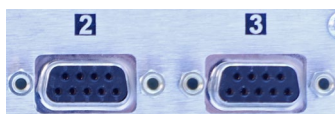

PN 399-580 ... -582 are a custom cable assemblies provided in different lengths from INFICON for connecting the VGC083C to INFICON PGE050 gauge or MKS Instruments / Granville-Phillips® 275 Convectron® vacuum gauge sensor. Connect the DE-9 D-subminiature connector to VGC083C and PGE050 connectors to "2" or "3".

For your reference, the wiring chart for the PGE050 cable provided by INFICON is shown below. In addition to INFICON provided standard cable assembly lengths, INFICON will provide custom length cable assemblies upon request.

VGC083C pin no.	connects to	PGE050 gauge pin no. (INFICON molded, custom connector)
1	⇒	n.c.
2	⇒	cable shield
3	⇒	3
4	⇒	3
5	⇒	2
6	⇒	5
7	⇒	1
8	⇒	1
9	⇒	n.c.

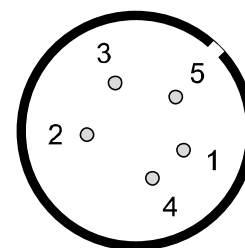

4.2.5 Power Connection

The VGC083C requires an input power of 20 ... 28 V (dc), 12 W to operate. One each 2-contact pluggable terminal strip mating connector is provided for connection to the power contactors. Optional power supplies are also available from INFICON (PN → 70).

Power (contacts)	Contact Description	Power Input Connector
+	Power input (20 ... 28 V (dc), 12 W)	
-	Power ground	

4.2.6 Relay Connection

A total of six setpoint relays are provided by the VGC083C. Two each 9-contact pluggable terminal strip mating connectors are provided for easy connection to the relay contactors. The VGC083C back panel relay connectors are marked RLY1 thru RLY6. Each relay has a contact labeled = (Normally Open), ≠ (Normally Closed) and I (common).

RLY1 thru RLY6 (contacts)	Contact Description	Relay Connectors
=	Relay #1 to Relay #6 (NORMALY OPEN)	
≠	Relay #1 to Relay #6 (NORMALY CLOSED)	
I	Relay #1 to Relay #6 (COMMON)	

4.2.7 Analog Output Connection

A total of three analog outputs are provided by the VGC083C. These output voltage signals are proportional to the displayed pressure for any of the user assigned vacuum gauges. Three each 2-contact pluggable terminal strip mating connectors are provided for connection to the analog output contactors. The VGC083C back panel analog output connectors are marked AO1, AO2 and AO3. Each connector has a contact labeled + (analog output signal) and - (analog output ground).

AO1 , AO2, AO3 (contacts)	Contact Description	Analog Output Connectors
+	Analog Output #1 to #3 (Signal)	
-	Analog Output Ground #1 to #3 (Signal Return)	

4.2.8 Analog Input Connection (Capacitance Diaphragm Gauges, etc.)

One analog input is provided by the VGC083C for using as an alternate gauge to "2". This input can be accepted from one capacitance diaphragm gauge or other INFICON vacuum module series PGE300, PGE500 or BAG302. One each 3-contact mating pluggable terminal strip connector is provided for connection to the analog input contactor. The VGC083C back panel analog input connector is marked A1. Each connector has a contact labeled + (analog input signal) and - (analog input ground) and D (power detect).

A1 (contacts)	Contact Description	Analog Input Connector
+	Analog Input (Signal)	
-	Analog Input Ground (Signal Return)	
D	Detect (power detect)	

When using a capacitance manometer / diaphragm gauge or INFICON modules such as the PGE300, PGE500, BAG302 as an ALTERNATE GAUGE, the gauge must be connected to the VGC083C as shown below. The alternate gauge must be provided power from an auxiliary power supply capable of providing the power required by the alternate gauge connected to the VGC083C. The D contact is used in this configuration to protect the IG from being turned on at high pressure in case power to the alternate gauge is lost.

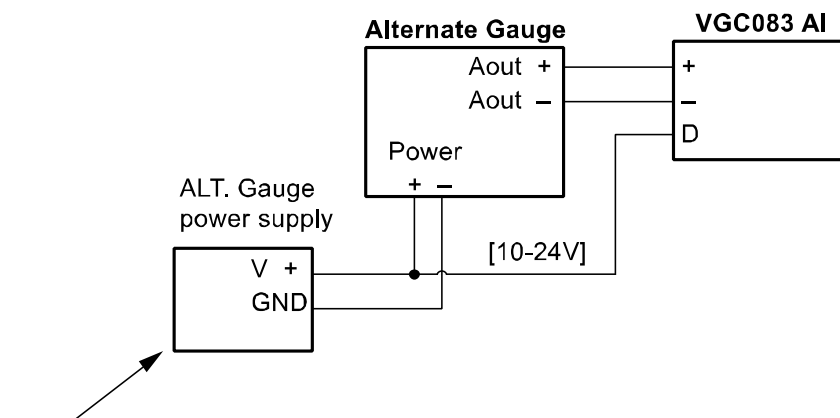

An Auxiliary Power Supply is required for your Alternate Gauge, e.g., a CDG. Ensure power is applied to your Alternate Gauge before turning on the power to VGC083.

4.2.9 Digital I/O Connection

The IG can be controlled manually using the front panel soft-keys, via remote input signals using the digital I/O connector or RS232/RS485 commands. The VGC083C can also be configured so that the IG **I** sensor on/off is controlled by using the pressure measurements from CG1 **2**, CG2 **3** or the alternate gauge. If the user prefers digital I/O as the means of controlling the IG **I**, various control input and status output signals are available from the 9-pin D-sub male DIGITAL I/O connector. The DIGITAL I/O Connector also provides pin-pin compatible signals with the GP 358 vacuum gauge controller as well as compatible signals with the GP 307.

The DIGITAL I/O Connector provides three different types of signals as listed below:

Signal Type A - Control Input Signals

The IG **I** sensor on/off can be set by applying momentary continuity to ground. This requires a momentary ground of less than 0.4 V (dc) at 10 μ A for 25 msec (minimum) be applied. After this, the input must be allowed to float higher than 3.5 V (dc) for 105 msec (minimum) before another low can be applied.

Input signal: Apply momentary continuity to ground to turn IG **I** sensor on or off

Signal Type B - Status Output Signal

The IG **I** on/off status relay is also available as both normally open and normally closed to indicate IG is on or off. This is an output signal to other external instruments to confirm IG filament is on or off. The IG on / off status relay is a single pole, double-throw (SPDT) relay rated at 1.0 A, 30 V (dc) resistive or 1.0 A, 30 V (ac) non-inductive.

Signal Type C - Error output Signal

This can be used as an output signal to other external instruments to confirm whether any error conditions exist.

Signal: Open collector transistor (ground emitter) rated at 40 V max. VCE, 50 mA IC max.

Transistor on = error condition exists,
Transistor off = no error condition exists

9-pin (DE-9P) D-subminiature DIGITAL I/O Connections

Pin no.	Description	Signal Type	Digital I/O Connector
1	IG Sensor on/off	A	
2	Ground		
3	n.a.	A	
4	IG on/off Status relay common	B	
5	IG on/off status relay - Normally Closed Relay open = IG on	B	
6	n.a.	A	
7	Ground		
8	Error status, Low = error exists	C	
9	IG on/off status relay - Normally open Relay closed = IG on	B	

4.2.10 RS232 / RS485 Serial Communications Connection

Either RS232 or RS485 serial communications may be used to send / receive commands to / from the VGC083C. There are two DE9 (D-subminiature, shell size E, 9 pole) connectors that allow independent cable connections to the RS232 and RS485 serial communication ports. Six serial communication protocols are supported.

1. RS485 with address, start and stop characters and command / response syntax derived from the INFICON BAG302 IG protocol.
2. RS232 with start and stop characters, but no addressing is used. The syntax is the same as the RS485 protocol.
3. RS232 protocol compatible with the Granville-Phillips Series 307 and 358 controllers.
4. RS485 protocol compatible with the Granville-Phillips Series 307 and 358 controllers.

The RS232 serial port is configured to allow, for example, a 9-pin extension cable, male to female, wired "pin-to-pin" to be connected from the VGC083C to your serial port. DO NOT connect both of the RS232 and RS485 cables to the VGC083C at the same time. The VGC083C cannot provide both RS232 and RS485 serial communications at the same time. Only one or the other as programmed by the user.

An extension cable wired pin-to-pin may be used to connect the RS232 serial port on the VGC083C directly to your PC serial port (a converter may be necessary).



DE-9 Connectors for connections to user supplied cables for serial communication port – DE9P (RS485), DE9S (RS232)

9-contact (DE-9S) D-subminiature RS232 Connections

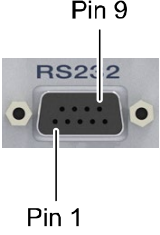
Socket no.	Description	RS232 Connector
1	No connection	
2	Transmitted Data (OUT)	
3	Received Data (IN)	
4	No connection	
5	Signal Ground	
6	No connection	
7	No connection	
8	No connection	
9	No connection	

Connect either RS232 or RS485 cable to VGC083C - DO NOT CONNECT BOTH AT THE SAME TIME

9-pin (DE-9P) D-subminiature RS485 Connections

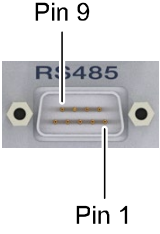
Pin no.	Description	RS485 Connector
1	DATA A (-)	
2	DATA B (+)	
3	No connection	
4	No connection	
5	No connection	
6	Signal Ground	
7	No connection	
8	No connection	
9	No connection	

Connect either RS232 or RS485 cable to VGC083C - DO NOT CONNECT BOTH AT THE SAME TIME

5 Operation - IG and CG

5.1 IG Over Pressure Shut Down

The MAG050 / MAG060 cold cathode ion gauge will shut off automatically should the pressure reach or rise above the overpressure shut down value shown below. If desired user can adjust the OVER PRESSURE value in the ION GAUGE menu:

Overpressure Shut Down		
Torr	mbar	Pa
5.00×10^{-3}	6.65×10^{-3}	6.65

5.2 Convection Gauge (CG) Initial Setup

Two of the most important steps for the initial setup of the convection gauges are to set zero (SET VAC) and set atmosphere (SET ATM) as described in the CONVEC GAUGE section 6.5.3. This will ensure proper operation of the gauge and accurate pressure measurements. The gauge is calibrated at the factory using nitrogen. Furthermore, the gauge is also installed in a certain orientation when calibrated at the factory. Without setting zero and atmosphere after the gauge is installed in your system, the gauge may not display the expected and correct pressures. This could be caused by the fact that you may be using a different gas than Nitrogen such as air to setup and calibrate the gauge (most commonly the case) and the gauge orientation is different than the orientation used at the factory. As such, it is very important to perform your own initial setup and calibration by setting zero and atmosphere with the gauge installed in your actual system. Please note the following:

Setting Zero (SET VAC)

Setting zero optimizes performance of the gauge when operating at a low pressure range of 1.00×10^{-4} Torr to 1.00×10^{-3} Torr. If your minimum operating pressure is higher than 1.00×10^{-3} Torr, it is not normally necessary to set zero and thus setting atmosphere should be adequate. If you are able to evacuate your system to below 1.00×10^{-4} Torr, it is always a good practice to check and set zero if necessary. See "SET VAC CG1" or SET "VAC CG2" in CONVEC GAUGE section 6.5.3.

Setting Atmosphere (SET ATM)

Setting atmosphere is the most important step for a newly installed gauge. If you prefer to use air to set atmosphere, vent your vacuum system chamber to expose the gauge to the local atmospheric pressure (air) and set atmosphere to match your known local uncorrected barometric pressure (air). This is the reading of ambient air pressure you will expect if you were to vent and open your vacuum chamber to the atmosphere surrounding the outside of your chamber. At sea level, this pressure is usually near 760 Torr. At elevations above sea level, the pressure decreases. Check your local aviation authority or airport web sites or your current local weather conditions online to help find your local uncorrected barometric pressure if you do not have this information. See "SET ATM CG1" or "SET ATM CG2" CONVEC GAUGE section 6.5.3.

NOTE

Setting zero and atmosphere is normally required only once during the initial setup and maybe checked by the user periodically. After power has been applied to the gauge during the initial setup, allow five minutes for the gauge to stabilize (warm-up) before setting zero and atmosphere.

The information presented in sections 5.1 and 5.2, above, is intended as an introduction to the programming capabilities of the VGC083C for use in controlling the selectable parameters and functions of the MAG050 / MAG060 IG and PEG050 CG transducers. Refer to the Operating Manuals for the MAG050 / MAG060 ion gauge and PEG050 convection gauge for complete operation and setup instructions of these connected devices.

5.3 Cond Cathode Activation Delay

The cold cathode gauge will exhibit some level of activation time delay when the sensor is being activated at pressures below 1.00E-05 Torr. This is the time needed for the electrical discharge to establish itself at low pressures. The delay time increases at low pressures, and is typically:

7.5×10^{-8} Torr	≈	0.1 minute
7.5×10^{-9} Torr	≈	1 minute
7.5×10^{-10} Torr	≈	5 minutes

6 Setup and programming

6.1 Applying Power

Before you turn on power to the VGC083C for the first time, ensure the cables from the VGC083C to the MAG050 / MAG060 and PGE050 convection gauges are connected and secured. Turn on power by pressing the Power key.

6.2 Front Panel Display

Display - Pressure Measurement

The VGC083C provides three independent front panel LED displays:

- **1** (IG) display represents pressure measurements from the MAG050 / MAG060 ion gauge.
- **2** (CG1) display represents pressure measurements from the first convection gauge.
- **3** (CG2 or CG2-ALT) display represents pressure measurements from the second convection or an alternate gauge.

Display - Units of Measure

A white LED is illuminated next to the selected engineering unit indicating measurements in Torr, mbar or Pa (the pascals unit of measure is indicated as 'Pa' on the front panel; millibars unit is indicated as mbar).

Display - Setup Screen

The VGC083C provides an independent setup and programming OLED setup screen. This screen is used for set up, programming and operation of the ion and convection vacuum gauges. Other useful information such as relay status indicators and error messages are also displayed in the setup screen.

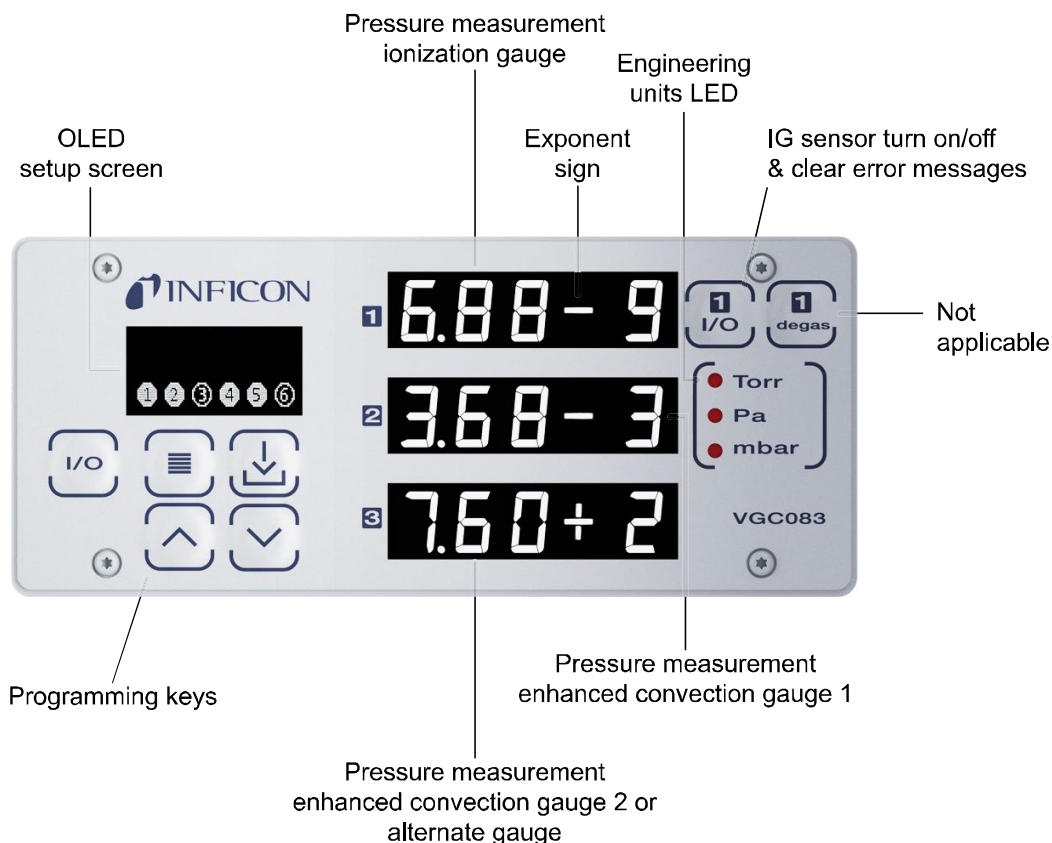

6.3 User Interface Basics

The setup and programming of the VGC083C controller is done via the four programming-keys located below the OLED setup screen on the left hand side of the VGC083C front panel. During programming of the VGC083C, the OLED display will identify what function each key represents.

To begin programming, press the MENU key. Press the UP and DOWN key to select the desired menu and change the parameters. Press the ENTER key to access the parameters and save the new settings. Press the MENU Key to return to the previous menu or press repeatedly to return to the main screen. To continue setting additional parameters, scroll with the UP and DOWN keys until you reach the desired parameter then press ENTER.

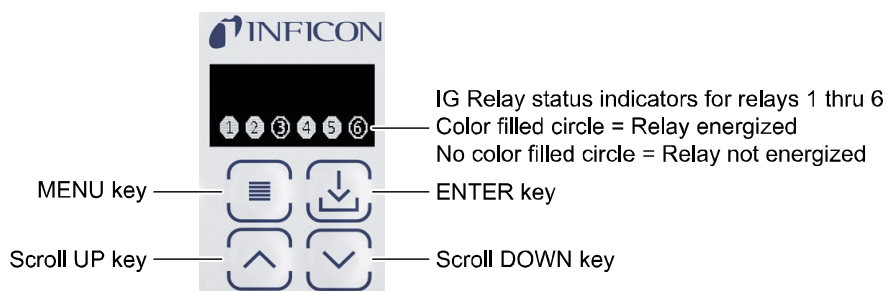

NOTE

The value of certain menu parameters must be programmed within an allowable range or limit. If the user tries to program a value that is outside of the allowable range of a specific menu, the setup screen will momentarily display the message "NO CHANGE". In this case, the user needs to access the specific menu again, and enter a correct value that is within the allowable range.

6.4 Factory-Set Default Parameters

The following is a summary of all factory-set default values in the VGC083C setup screen menu.

SETUP UNIT

- UNITS [Factory default = TORR]
- INFO [Factory default = FIRMWARE VERSION]
- SET CG2-ALT [Factory default = CG2]
- ALT GAUGE [Factory default = 10 TORR CDG]
- ALT GAUGE CAL [Factory default = Factory Set Number]
- DEFAULTS [Factory default = PRESS ENTER TO SET OR MENU TO EXIT (not useable if IG sensor is on)]

ION GAUGE

- HV TIMEOUT [Factory default = 2 minutes]
- SENSITIVITY [Factory default = 10.00]
- OVER PRES 100 [Factory default = 5.00E-03]
- IG TRIP PRES [Factory default = 1.00E-03]
- IG CONTROL [Factory default = MANUAL MODE]
- CAL FACTORS [Factory default = C0, C1, C2, C3, C4, C5 all factory-set to 50]
- IG CONTROL [Factory default = MANUAL MODE]

CONVEC GAUGE

- SET VAC CG1 [Factory default = 0.00E 00]
- SET ATM CG1 [Factory default = 7.60E 02 TORR]
- SET VAC CG2 [Factory default = 0.00E 00]
- SET ATM CG2 [Factory default = 7.60E 02 TORR]

RELAYS

- ASSIGN REL 1 [Factory default =ION GAUGE]
- ASSIGN REL 2 [Factory default =CG1]
- ASSIGN REL 3 [Factory default =CG2]
- ASSIGN REL 4 [Factory default =ION GAUGE]
- ASSIGN REL 5 [Factory default =CG1]
- ASSIGN REL 6 [Factory default =CG2]
- REL 1 LO TRIP [Factory default = 1.00E-06]
- REL 1 HI TRIP [Factory default = 2.00E-06]
- REL 2 LO TRIP [Factory default = 1.00E-01]
- REL 2 HI TRIP [Factory default = 2.00E-01]
- REL 3 LO TRIP [Factory default = 1.00E-01]
- REL 3 HI TRIP [Factory default = 2.00E-01]
- REL 4 LO TRIP [Factory default = 1.00E-06]
- REL 4 HI TRIP [Factory default = 2.00E-06]
- REL 5 LO TRIP [Factory default = 1.00E-01]
- REL 5 HI TRIP [Factory default = 2.00E-01]
- REL 6 LO TRIP [Factory default = 1.00E-01]
- REL 6 HI TRIP [Factory default = 2.00E-01]
- TEST RELAYS

ANALOG OUTPUT

- ANALOG OUT 1 [Factory default = IG - CG1 0.5 - 7V]
- ANALOG OUT 2 [Factory default = CG1 1 - 8 V]
- ANALOG OUT 3 [Factory default = CG2 1 - 8 V]
- AOUT CAL 1 [Factory default = Factory Set Number]
- AOUT CAL 2 [Factory default = Factory Set Number]
- AOUT CAL 3 [Factory default = Factory Set Number]
- AOUT LIN 1 [Factory default = 1.00E 00]
- AOUT LIN 2 [Factory default = 1.00E 00]
- AOUT LIN 3 [Factory default = 1.00E 00]

SERIAL COMM

- COMM TYPE [Factory default = RS485]
- BAUDRATE [Factory default = 19200 BAUD]
- FRAMING [Factory default = 8 BITS NONE 1]
- ADDRESS [Factory default = 01]

DISPLAY

- SCREEN SETUP [Factory default = NORMAL]
- SCREEN SAVER [Factory default = ON]
- BRIGHTNESS [Factory default = 0]
- LED BRIGHTNESS [Factory default = 8]

6.5 Programming

This section provides detailed information on programming and configuration of various menus and submenus of the device.



This key, on the VGC083C front panel, is referred to as the 'ENTER' key throughout this manual.

From the main menu (press the MENU key if the main menu is not shown), scroll Up or Down to SETUP UNIT then press the ENTER key to access the SETUP UNIT menu for configuring the VGC083C general parameters such as the units of measure, selecting CG2 verses ALTERNATE GAUGE, etc. In certain instances, during setup of the programmed functions and settings, you may need to press the ENTER key until you reach the end of a program/setup sequence before pressing the MENU key to return to the main menu or previous setup screen.

6.5.1 SETUP UNIT

UNITS	<p>[Factory default = TORR]</p> <p>This allows the user to display the pressure measurements in Torr, mbar or pascals. The user must program all other programming values according to their requirements.</p>
INFO	<p>[Factory default = FIRMWARE VERSION]</p> <p>Displays type of ion gauge (IG) it operates as COLD CATHODE and the firmware version numbers associated with the VGC083C controller and the VGC083C internal board that operates the IG.</p>
SET CG2 - ALT	<p>[Factory default = CG2]</p> <p>This allows the user to assign the type of gauge to the CG2/ALT display. The user can either assign a second convection gauge CG2 (same type as CG1 using INFICON's PGE050 convection gauge sensor) or an analog voltage input signal from an alternate gauge. The ANALOG INPUT selection allows processing of one analog input voltage signal from INFICON's capacitance diaphragm gauge (CDG) or other brands of CDGs with a 0-10 V (dc) output signal. The ANALOG INPUT selection can also provide processing of one analog input voltage signal from INFICON vacuum gauge modules PGE500, PGE300, BAG302. Note that using a CDG or the INFICON vacuum gauge modules listed above requires the user to provide an external power source to these devices.</p>
ALT GAUGE	<p>[Factory default = 10 TORR CDG]</p> <p>Ignore this menu if you have selected CG2 in the SET CG2 - ALT menu above. If you have selected ANALOG INPUT in the SET CG2 - ALT menu above, the ALT GAUGE menu selection is used to assign the type of alternate gauge.</p> <ul style="list-style-type: none"> • Select 100 mTORR CDG for a 100 mTorr Capacitance Manometer / Diaphragm Gauge (CDG) with 0-10 V (dc) analog output. • Select 20 TORR CDG for a 20 Torr full scale CDG with 0-10 V (dc) analog output. Other full scale selections are 50 TORR CDG, 100 TORR CDG, 200 TORR CDG, 500 TORR CDG, 1000 TORR CDG, 10 mTORR CDG, 20 mTORR CDG, 50 mTORR CDG, 100 mTORR CDG, 250 mTORR CDG, 500 mTORR CDG, 1 TORR CDG, 2 TORR CDG and 5 TORR CDG. • Select ITI LOG CG if you are using INFICON's convection gauge modules such as the PGE300 or PGE500 with a Log-linear analog output. • ITI LOG IG7V is reserved for future use. Currently not applicable. • Select ITI LOG IG if you are using INFICON's ionization gauge module such as the BAG302 IG with a Log-linear analog output. • Select ITI NON-LINEA if you are using INFICON's convection gauge modules such as the PGE300 or PGE500 with a non-linear analog output.
ALT GAUGE CAL	<p>[Factory default = Factory Set Number]</p> <p>Ignore this menu if you have selected CG2 in the SET CG2 - ALT menu above. If you have selected ANALOG INPUT in the SET CG2 - ALT menu above, the ALT GAUGE CAL menu selection is used to optimize the analog input calibration. It is recommended that the user not make this adjustment unless the displayed alternate gauge pressure (CG2/ALT display channel) do not closely match the expected pressure from the analog input calculations.</p> <p>Example - To perform ALT GAUGE CAL if ALT GAUGE menu is selected for a 1000 TORR CDG. Connect both the CDG and a high resolution voltmeter to the + and – terminals of the VGC083C Analog Input Connector labeled AI. With CDG exposed to atmosphere, measure the analog input from the CDG at the VGC083C Analog Input Connector and calculate the corresponding pressure. In the ALT GAUGE CAL screen use the UP or DOWN keys to adjust the displayed pressure by the VGC083C to match the calculated pressure from the CDG analog signal. For example, if the analog input signal from the CDG is at 7.600 volts representing 760 Torr for a 1000 TORR CDG, then adjust the ALT GAUGE CAL so that the VGC083C also displays 760 Torr. For other CDG ranges always use CDG's full scale pressure value to perform calibration. For example, if you are using a</p>

100 TORR CDG, evacuate your system pressure to 100 Torr and use the same calibration procedure above.

Example - To perform ALT GAUGE CAL if ALT GAUGE menu is selected for ITI LOG CG, ITI LOG IG or ITI NON-LINE. When using other INFICON vacuum gauge modules such as PGE300, PGE500 or BAG302 as alternate gauges to CG2, the analog output signals from these devices can be used to display pressure in the CG2/ALT display channel. Connect the analog output from these devices to the + and – terminals of the VGC083C Analog Input Connector labeled AI. In the ALT GAUGE CAL screen use the UP or DOWN keys to adjust the displayed pressure by the VGC083C to match the pressure reading on the modules.

NOTE As you adjust the analog output, the number being displayed in the ALT GAUGE CAL screen represents the millivolts offset from zero volts that is being used internally for the analog input gain adjustment.

DEFAULTS

[Factory default = PRESS ENTER TO SET OR MENU TO EXIT]

The system can be returned to the original factory settings by using the ENTER key to set factory defaults.

If you reset all values to original factory default settings, you would need to repeat the initial setup procedure for the convection gauges as described in section 5.2 and reprogram other parameters as required.

6.5.2 ION GAUGE

NOTICE Before you activate the ion gauge sensor, make sure you understand all instructions and information provided in this manual and the Operating Manuals for the MAG050 / MAG060 cold cathode ion gauge and the PGE050 convection gauge. Furthermore, you should ensure you have fully configured the VGC083C control unit to your operational requirements before turning the ion gauge sensor on. Prior to turning on the ion gauge sensor you should ensure the pressure is below the OVER PRESSURE value programmed in the VGC083C. Press the ENTER Key to access the ION GAUGE menu for configuring the MAG050 / MAG060 ionization gauge sensor.

HV TIMEOUT

[Factory default = 2 minutes]

Enter this menu choice to program the maximum wait period after the cold cathode sensor on command is invoked and the MAG050 / MAG060 starts to read pressure. This time period can be set from 1 to 60 minutes. Default setting is 2 minutes.

The cold cathode gauge will exhibit some level of activation time delay when the sensor is being activated at pressures below 1.00E-05 Torr. This is the time needed for the electrical discharge to establish itself at low pressures. The delay time increases at low pressures, and is typically:

7.5×10^{-8} Torr	≈	0.1 minute
7.5×10^{-9} Torr	≈	1 minute
7.5×10^{-10} Torr	≈	5 minutes

The HV TIMEOUT is the time allowed for the gauge to activate during which time the unit will attempt repeatedly to turn on the anode voltage. If the gauge has not been activated after this time has elapsed, the unit will stop attempting to turn on the anode voltage and the user will be prompted with "DISCHARGE FAIL" or "CURRENT FAIL" error messages. If this is the case, the user must clear the error and repeat the process of turning on the anode voltage again.

SENSITIVITY

[Factory default = 10]

Factory pre-set SENSITIVITY for the MAG050 / MAG060 is always 10 and may be adjusted by the user if necessary. Ion gauge pressure readings are calibrated for air/nitrogen. If you use a different species of gas or mixture of gases you will be required to either make manual corrections to the pressure readout or compensate the reading. The SENSITIVITY value programmed in the VGC083C can be adjusted to compensate the reading for a gas other than nitrogen/air. Compensating

the pressure reading using the SENSITIVITY adjustment method may not be possible for certain gases if the new calculated SENSITIVITY results in a value outside the adjustment range.

⚠ CAUTION! The user assumes all risks if the SENSITIVITY is programmed to a value not matching the actual head (sensor) sensitivity described above. Failure to ensure that the VGC083C is programmed for the actual sensitivity of the head it is used with may result in pressure readings that are not true pressure. Equipment damage due to incorrect pressure readings and improper system control functions as a result of incorrect pressure measurement readings may result.

OVER PRESSURE

[Factory default = 5.00E-03]

This function allows the user to set the pressure at which the gauge will turn off when the vacuum vessel pressure rises above this setting. The overpressure shut down values are adjustable - set this value to a pressure level that is acceptable for your application. Operating any ion gauge at too high of a pressure in the presence of certain gases and gas mixtures may result in significant sputtering action of the internal electrodes of the transducer (sensor) leading to changes in performance of the device.

IG TRIP PRES

[Factory default = 1.00E-03]

This setting allows the user to select a pressure value at which CG1, CG2 or ALT GAUGE can turn the cold cathode sensor on. The IG TRIP PRES value for the MAG050 / MAG060 can never be set higher than 5.00E-03 Torr.

IG CONTROL

[Factory default = MANUAL MODE]

This function allows the user to choose the source of control for the IG. The IG can be controlled from the Front Panel (MANUAL MODE), CG1, CG2 or the ALT GAUGE.

Select MANUAL MODE if you wish to use the front panel IG ON/OFF key to turn the cold cathode ion gauge sensor to the on or off state.

Select CG1, CG2 or ALT GAUGE if the pressure measurement from CG1 or CG2 or the Alternate Gauge is to be used to automatically turn the ion gauge sensor on and off.

When CG1, CG2 or ALT GAUGE is selected in the IG CONTROL menu, the user cannot turn off or turn on the IG sensor manually using the IG ON/OFF key of the front panel, RS232, RS485 or DIGITAL I/O signals.

CAL FACTORS

[Factory default = C0, C1, C2, C3, C4, C5 all factory-set to 50]

Do not change CAL FACTORS values. This menu is intended for future enhancement of the VGC083C capabilities. Leave C0, C1, C2, C3, C4, and C5 CAL FACTORS values at the factory default setting of 50. Changing these values to a number other than 50 will result in inaccurate vacuum pressure measurements.

6.5.3 CONVEC GAUGE

NOTICE

It is important to set vacuum and atmosphere when initially setting up the convection gauges. See Convection Gauge Initial Setup section 5.2

This programming menu allows the user to set the atmospheric pressure reading (also known as the "span" adjustment) and vacuum reading ("zero" point) for convection gauges CG1 and CG2. INFICON advises that you first determine if the "span" (ATM) adjustment of your measurement device is set properly before setting the "zero" (VAC) adjustment. It is good practice to perform the sequence of checking and adjusting ATM (span) then VAC (zero) and then, finally re-checking the ATM setting to ensure that the circuitry is properly balanced for use in measuring pressure throughout the intended measurement range. Press the ENTER key to access the CONVEC GAUGE menu for configuring the convection gauges.

SET VAC CG1

[Factory default = 0.00E 00]

Press the ENTER key to access the SET VAC CG1 screen.

1. To properly set the vacuum reading ("zero" point), with CG1 installed on your vacuum system, the gauge should be evacuated to a pressure below 1.00E-04 Torr (0.1 mTorr). [Factory default = 0.00E+0 Torr]
2. When the known vacuum system pressure is below 0.1 mTorr and If you want to set zero at 0.00E+0, then press the ENTER key repeatedly until the SET VAC CG1 appears on the display again. The zero point (displayed pressure reading with gauge exposed to vacuum) is now set.

If you want to set the 'zero' pressure reading to a number higher than 0.00E+0, then press the UP or DOWN keys at each of the high-lighted numeral locations until the desired number is reached; then press the ENTER key repeatedly until the SET VAC CG1 appears on the display again. The new "zero point" is now set. Due to the nature of circuit operation and head electrical control that cover a wide range of measurement by a convection gauge, it is advised that one first check and adjust, if necessary, the "span" and "zero" to ensure that all measurements made between these two, adjusted settings are as accurate as possible.

SET ATM CG1

[Factory default = 7.60E 02 TORR]

Press the ENTER key to access the SET ATM CG1 screen.

Backfill the vacuum vessel /chamber with nitrogen gas to a known pressure between 400 Torr and 1000 Torr. Alternatively, if your local uncorrected barometric pressure (air) is known, simply vent your vacuum system chamber to expose the gauge to the local atmospheric pressure. When desired system pressure is stable, adjust the pressure on the screen to the known value using the UP or DOWN keys. Press the ENTER key to move to the next digit and use the UP or DOWN keys to decrease or increase the value of that digit. Continue pressing the ENTER key until the SET ATM CG1 reappears on the display. The new atmosphere point is now set. For example, if your known local uncorrected barometric pressure is 760 Torr, enter 760 in the SET ATM screen. The main pressure measurement screen will now display 760 Torr while the gauge is at atmosphere.

SET VAC CG2

[Factory default = PRESS ENTER TO SET VAC]

Same as SET VAC CG1 above, except for CG2

SET ATM CG2

[Factory default = 7.60E 02 TORR]

Same as SET ATM CG1 above, except for CG2.

6.5.4 RELAYS

Press the ENTER key to access the RELAYS menu for configuring the setpoint relays.

ASSIGN REL 1

[Factory default = ION GAUGE]

This assigns Relay #1 to the ion gauge, CG1, CG2 or ALT GAUGE (alternate gauge).

ASSIGN REL 2

[Factory default = CG1]

ASSIGN RELAY 2; same choices as ASSIGN RELAY 1 above

ASSIGN REL 3

[Factory default = CG2]

ASSIGN RELAY 3; same choices as ASSIGN RELAY 1 above

ASSIGN REL 4

[Factory default = ION GAUGE]

ASSIGN RELAY 4; same choices as ASSIGN RELAY 1 above

ASSIGN REL 5	<p>[Factory default = CG1]</p> <p>ASSIGN RELAY 5; same choices as ASSIGN RELAY 1 above</p>
ASSIGN REL 6	<p>[Factory default = CG2]</p> <p>ASSIGN RELAY 6; same choices as ASSIGN RELAY 1 above</p>
REL 1 LO TRIP	<p>[Factory default = 1.00E-06]</p> <p>This setpoint corresponds to the turn on point for Relay #1. Relay #1 will turn on when the pressure drops below this setting. If you are unable to increase the value of REL 1 LO TRIP (VGC083C responding with the message "NO CHANGE"), you must first access the REL 1 HI TRIP menu below and increase that value to a number higher than the value of the REL 1 LO TRIP you are trying to set. Ensure the REL 1 LO TRIP setpoint value you are programming is within the measurement range of the specific gauge the relay is assigned to.</p>
REL 1 HI TRIP	<p>[Factory default = 2.00E-06]</p> <p>This setpoint corresponds to the turn off point for Relay #1. Relay #1 will turn off when the pressure rises above this setting. If you are unable to decrease the value of REL 1 HI TRIP (VGC083C responding with the message "NO CHANGE"), you must first access the REL 1 LO TRIP menu above and decrease that value to a number lower than the value of the REL 1 HI TRIP you are trying to set. Ensure the REL 1 HI TRIP setpoint value you are programming is within the measurement range of the specific gauge the relay is assigned to.</p>
REL 2 LO TRIP	<p>[Factory default = 1.00E-01]</p> <p>(RELAY 2 LO TRIP; same info as RELAY 1 LO TRIP above)</p>
REL 2 HI TRIP	<p>[Factory default = 2.00E-01]</p> <p>(RELAY 2 HI TRIP; same info as RELAY 1 HI TRIP above)</p>
REL 3 LO TRIP	<p>[Factory default = 1.00E-01]</p> <p>(RELAY 3 LO TRIP; same info as RELAY 1 LO TRIP above)</p>
REL 3 HI TRIP	<p>[Factory default = 2.00E-01]</p> <p>(RELAY 3 HI TRIP; same info as RELAY 1 HI TRIP above)</p>
REL 4 LO TRIP	<p>[Factory default = 1.00E-06]</p> <p>(RELAY 4 LO TRIP; same info as RELAY 1 LO TRIP above)</p>
REL 4 HI TRIP	<p>[Factory default = 2.00E-06]</p> <p>(RELAY 4 HI TRIP; same info as RELAY 1 HI TRIP above)</p>
REL 5 LO TRIP	<p>[Factory default = 1.00E-01]</p> <p>(RELAY 5 LO TRIP; same info as RELAY 1 LO TRIP above)</p>
REL 5 HI TRIP	<p>[Factory default = 2.00E-01]</p> <p>(RELAY 5 HI TRIP; same info as RELAY 1 HI TRIP above)</p>
REL 6 LO TRIP	<p>[Factory default = 1.00E-01]</p> <p>(RELAY 6 LO TRIP; same info as RELAY 1 LO TRIP above)</p>

REL 6 HI TRIP

[Factory default = 2.00E-01]

(RELAY 6 HI TRIP; same info as RELAY 1 HI TRIP above)

TEST RELAYS

[Factory default = OFF]

This allows the user to manually toggle the relays on and off to test for correct external circuit wiring and ensure polarity is as desired. Press ENTER to access the TEST RELAYS menu. Select a specific relay by pressing the ENTER key so that the relay number is highlighted. Press the UP or DOWN key to energize the specific relay.

Relays will return to the previous state after exiting the TEST RELAYS menu.

6.5.5 Analog Output

The VGC083C provides three analog outputs proportional to the pressure measured by the ionization gauge, the selected convection gauge (CG1 or CG2) or a continuous, combined output signal from the IG and CG1 (IG - CG1) for full range measurement. Press the ENTER key to access the ANALOG OUTPUT menu for configuring the analog outputs.

ANALOG OUT 1

[Factory default = CG1 - CG1]

This menu provides various scaling and gauge type selections for Analog Output #1. Use the UP and DOWN keys to select the desired analog output configuration from the following available choices.

IG - CG1 0.5 - 7V	Log-linear analog output combining IG & CG1 as one signal
IG - CG2 0.5 - 7V	Log-linear analog output combining IG & CG2 as one signal
IG - ALT 0.5 - 7V	Log-linear analog output combining IG & Alternate gauge as one signal
IG LOG N - 10	Log-linear analog output for IG only, output also compatible with GP 307, 350
IG LOG N - 11	Log-linear analog output for IG only, output also compatible with GP 307, 350, 358
IG LOG N - 12	Log-linear analog output for IG only, output also compatible with GP 307, 350
IG 1.8 - 8.7V	Log-Linear analog output for IG only
IG LINEAR	Linear analog output for IG only, output also compatible with GP 307
ALT LINEAR	Linear analog output for alternate gauge only
ALT CG 1-8V	Log-linear analog output if alternate gauge connected is an INFICON PGE300 or PGE500
ALT IG LOGN10	Log-linear analog output if alternate gauge connected is an INFICON BAG302
CG1 1 - 8V	Log-linear analog output for CG1
CG2 1 - 8V	Log-linear analog output for CG2
CG1 0 - 7V	Log-linear analog output for CG1 , output also compatible with GP 307,350,358
CG2 0 - 7V	Log-linear analog output for CG2 , output also compatible with GP 307,350,358
CG1 NON - LIN	Non-linear analog output for CG1
CG2 NON - LIN	Non-linear analog output for CG2
CG1 LINEAR	Linear analog output for CG1
CG2 LINEAR	Linear analog output for CG2

Select **"IG - CG1 0.5 - 7V"** as the analog output type to set the analog output voltage proportional to the pressure measured by the combination of IG plus CG1. This selection combines the analog output from the IG and CG1 as one signal to provide a log-linear analog output voltage of 0.5 volts to 7 volts with a scaling factor of 0.5 V/decade of measured pressure. The log-linear output signal and pressure are related by the following formulas when Pressure Unit of measurement is in Torr and mbar: $P = 10^{(\text{volts} - 5.5) / (0.5)}$ where P is the pressure in Torr or mbar, and V is the output signal in volts. Refer to section 7.1 for details regarding this type of output signal.

Select **"IG - CG2 0.5 - 7V"** as the analog output type to set the analog output voltage proportional to the pressure measured by the combination of IG plus CG2. The analog output characteristics is the same as described for **"IG - CG1 0.5 - 7V"** above.

Select **"IG - ALT 0.5 - 7V"** as the analog output type to set the analog output voltage proportional to the pressure measured by the combination of IG plus the Alternate gauge. The analog output characteristics is the same as described for **"IG - CG1 0.5 - 7V"** above. Note that the **"IG - ALT 0.5 - 7V"** selection is mainly intended for use with an alternate gauge which has a wide measurement range from atmosphere to the turn-on point for the ion gauge. INFICON convection gauges such as the PGE300 or PGE500 provide this capability. If you are using a capacitance diaphragm gauge (CDG) as an alternate gauge you may want to consider a different output since a single CDG may not provide measurements from atmosphere to the turn-on point for the ion gauge.

Select **"IG LOG N - 10"** as the analog output type to set the analog output voltage proportional to the pressure measured by the ion gauge only. This selection provides an output voltage that is linear with respect to the common logarithm of pressure, i.e., log-linear analog output of 0 to 9 volts with a scaling factor of 1 V/decade of measured pressure. The log-linear output signal and pressure are related by the following formulas when Pressure Unit of measurement is in Torr and mbar: $P = 10^{(\text{volts} - 10)}$ where P is the pressure in Torr or mbar, and V is the output signal in volts. Refer to section 7.2 for details regarding this type of output signal. This selection is compatible with the analog output scaling from the Granville-Phillips 307 and 350 controllers.

Select **"IG LOG N - 11"** as the analog output type to set the analog output voltage proportional to the pressure measured by the ion gauge only. This selection provides an output voltage that is linear with respect to the common logarithm of pressure, i.e., log-linear analog output of 0 to 10 volts with a scaling factor of 1 V / decade of measured pressure. The log-linear output signal and pressure are related by the following formulas when Pressure Unit of measurement is in Torr and mbar: $P = 10^{(\text{volts} - 11)}$ where P is the pressure in Torr or mbar, and V is the output signal in volts. Refer to section 7.3 for details regarding this type of output signal. This selection is also compatible with a certain analog output scaling from the Granville-Phillips 307, 350 and 358 controllers.

Select **"IG LOG N - 12"** as the analog output type to set the analog output voltage proportional to the pressure measured by the ion gauge only. This selection provides an output voltage that is linear with respect to the common logarithm of pressure, i.e., log-linear analog output of 0 to 11 volts with a scaling factor of 1 V / decade of measured pressure. The log-linear output signal and pressure are related by the following formulas when Pressure Unit of measurement is in Torr and mbar: $P = 10^{(\text{volts} - 12)}$ where P is the pressure in Torr or mbar, and V is the output signal in volts. Refer to section 7.4 for details regarding this type of output signal. This selection is also compatible with a certain analog output scaling from the Granville-Phillips 307 and 350 controllers.

Select **"IG 1.8 - 8.7V"** as the analog output type to set the analog output voltage proportional to the pressure measured by the ion gauge only. This selection provides an output voltage that is linear with respect to the common logarithm of pressure, i.e., log-linear analog output of 1.8 to 8.7 volts with a scaling factor of 0.8 V/decade of measured pressure. The log-linear output signal and pressure are related by the following formulas when Pressure Unit of measurement is in Torr $P = 10^{((1.25 \times \text{volts}) - 12.875)}$ where P is the pressure in Torr and V is the output signal in volts. Refer to section 7.5 for details regarding this type of output signal.

Select **"IG LINEAR"** as the analog output type to provide a 0-10 Vdc output signal that has a direct linear relationship to the displayed pressure measured by the ion gauge only. This selection covers 3 decades of pressure change. For example, if the maximum pressure selected is 1.00E-03 Torr (value programmed for AOUT LIN 1 or AOUT LIN 2 or AOUT LIN 3 menu below), then the instrument provides a 10 volt analog output signal when pressure is at 1.00E-03 Torr and the minimum pressure is automatically set to 1.00E-06 Torr, with a corresponding minimum volt-

age output of 0.01 volts. If your application requires the IG analog output voltage to cover a pressure range exceeding three decades, then consider using the log-linear analog outputs. Refer to section 7.6 for details regarding this type of output signal. This selection is also compatible with a certain analog output scaling from the Granville-Phillips 307 controller.

Select "**ALT LINEAR**" only if you have selected ANALOG INPUT in the SET CG2 - ALT menu intended for use with a CDG device as an alternate gauge to CG2. If such is the case, this analog output type provides a 0-10 Vdc analog output signal that has a direct linear relationship to the displayed pressure measured by the alternate gauge. This selection covers 3 decades of pressure change. Essentially, this allows retransmission of the same analog input signal being received by the VGC083C. For example, if ALT GAUGE selected is 1000 TORR CDG, the maximum pressure should also be programmed as 1.00E03 Torr (value programmed for AOUT LIN 1 or AOUT LIN 2 or AOUT LIN 3 menu below), then the instrument provides a 10 volt analog output signal when pressure is at 1.00E03 Torr and the minimum pressure is automatically set to 1.00 Torr, with a corresponding minimum voltage output of 0.01 volts.

Select "**ALT CG 1-8V**" only if you have selected ANALOG INPUT in the SET CG2 - ALT menu intended for use with an INFICON PGE300 or PGE500 convection vacuum gauge module as an alternate gauge to CG2. Essentially, this allows retransmission of the same analog input signal being received from the PGE300 or PGE500. This selection provides an output voltage that is linear with respect to the common logarithm of pressure, i.e., log-linear analog output of 1 to 8 volts with a scaling factor of 1 V/decade of measured pressure. The log-linear output signal and pressure are related by the following formulas when Pressure Unit of measurement is in Torr and mbar: $P = 10^{(volts - 5)}$ where P is the pressure in Torr or mbar, and V is the output signal in volts.

Select "**ALT IG LOGN10**" only if you have selected ANALOG INPUT in the SET CG2 - ALT menu intended for use with an INFICON BAG302 ionization vacuum gauge module as an alternate gauge to CG2. Essentially, this allows retransmission of the same analog input signal being received from the BAG302. This selection provides an output voltage that is linear with respect to the common logarithm of pressure, i.e., log-linear analog output of 0 to 9 volts with a scaling factor of 1 V/decade of measured pressure. The log-linear output signal and pressure are related by the following formulas when Pressure Unit of measurement is in Torr and mbar: $P = 10^{(volts - 10)}$ where P is the pressure in Torr or mbar, and V is the output signal in volts.

Select "**CG1 1 - 8V**" as the analog output type to set the analog output voltage proportional to the pressure measured by convection gauge CG1. This selection provides an output voltage that is linear with respect to the common logarithm of pressure, i.e., log-linear analog output of 1 to 8 volts with a scaling factor of 1 V/decade of measured pressure. The log-linear output signal and pressure are related by the following formulas when Pressure Unit of measurement is in Torr and mbar: $P = 10^{(volts - 5)}$ where P is the pressure in Torr or mbar, and V is the output signal in volts. Refer to section 7.7 for details regarding this type of output signal.

Select "**CG2 1 - 8V**" for CG2. Same as CG1 1 - 8V above, except for CG2.

Select "**CG1 0 - 7V**" as the analog output type to set the analog output voltage proportional to the pressure measured by convection gauge CG1. This selection provides an output voltage that is linear with respect to the common logarithm of pressure, i.e., log-linear analog output of 0 to 7 volts with a scaling factor of 1 V / decade of measured pressure. The log-linear output signal and pressure are related by the following formulas when Pressure Unit of measurement is in Torr and mbar: $P = 10^{(volts - 4)}$ where P is the pressure in Torr or mbar, and V is the output signal in volts. Refer to section 7.8 for details regarding this type of output signal. This selection is compatible with the analog output scaling from the Granville-Phillips 307, 350 and 358 controllers.

Select "**CG2 0 - 7V**" for CG2. Same as CG1 0 - 7V above, except for CG2. ^

Select "**CG1 NON - LIN**" as the analog output type to set the analog output (non-linear) voltage proportional to the pressure measured by convection gauge CG1. This produces a non-linear analog output signal of 0.375 to 5.659 V (dc) for 0 to 1000 Torr of N₂, roughly in the shape of an "S" curve. Refer to section 7.9 for details regarding this type of output signal. Note - This non-linear analog output is also equivalent to the Granville- Phillips® Mini-Convectron® non-linear S-curve analog output.

Select "**CG2 NON - LIN**" for CG2. Same as CG1 NON - LIN above, except for CG2.

Select "**CG1 LINEAR**" as the analog output type to provide a 0-10 Vdc output signal that has a direct linear relationship to the displayed pressure measured by CG1 only. This selection covers 3 decades of pressure change. For example, if the maximum pressure selected is 1.00 Torr (value programmed for AOUT LIN 1 menu below), then the instrument provides a 10 volt analog output signal when pressure is at 1.00 Torr and the minimum pressure is automatically set to 1 mTorr (1.00E-03 Torr), with a corresponding minimum voltage output of 0.01 volts. If your application requires CG1 or the analog output voltage to cover a pressure range exceeding three decades, then consider using the log-linear analog output type. Refer to section 7.10 for details regarding this type of output signal.

Select "**CG2 LINEAR**" for CG2. Same as CG1 LINEAR above, except for CG2.

ANALOG OUT 2

[Factory default = CG1 1 - 8V]

(Same selection choices as ANALOG OUT 1 above)

ANALOG OUT 3

[Factory default = CG2 1 - 8V]

(Same selection choices as ANALOG OUT 1 above)

AOUT CAL 1

[Factory default = Factory Set]

This has been pre-set in the factory and is used to optimize the analog output calibration. It is recommended that the user not make this adjustment unless the displayed pressure on the VGC083C and the resulting pressure recorded from the analog output do not match closely.

To perform AOUT CAL 1 adjustment if ANALOG OUTPUT 1 is programmed for IG LOG, IG LINEAR or ALT IG LOGN10. Connect the IG to the VGC083C and connect the VGC083C analog output 1 to a high resolution voltmeter, your system, PLC, etc. Evacuate your vacuum system to a low enough pressure for the IG to operate. Establish a system pressure so that the displayed IG reading is preferably at the high end of any decade (for example 9.00E-05 as opposed to 1.00E-05). In the AOUT CAL 1 screen use the UP or DOWN keys to adjust the analog output to match the corresponding pressure displayed on the IG pressure measurement display or the CG2/ALT display channel if using a BAG302 ion gauge module as an alternate gauge to CG2.

Example

ANALOG OUTPUT 1 is programmed for "IG LOG N - 10". The VGC083C IG display is registering a pressure reading of 9.00E-05 Torr. Based on the equation and table given in section 7.2 the expected analog output at 9.00E-05 Torr is 5.9542 V. While in the AOUT CAL 1 screen, use the UP or DOWN keys to set the analog output to 5.9542 V as recorded by your voltmeter. Alternatively, if the IG analog output is used to display the IG pressure on your PLC or system display console, simply adjust the AOUT CAL 1 so that the IG pressure displayed by your PLC (pressure established at the high end of any decade preferred) matches the IG pressure displayed by the VGC083C. Note - As you adjust the analog output, the number being displayed in the AOUT CAL 1 screen represents the millivolts offset from zero volts that is being used internally for the analog output gain adjustment.

To perform AOUT CAL 1 adjustment if ANALOG OUTPUT 1 is programmed for IG - CG1, CG1, CG2, CG1/CG2NON-LIN, CG1/CG2 LINEAR, ALT CG 1-8V. Connect CG1 or CG2 to the VGC083C and connect the VGC083C analog output 1 to a high resolution voltmeter, your system, PLC, etc. While in the AOUT CAL 1 screen and with CG1 or CG2 exposed to atmosphere, use the UP or DOWN keys to adjust the analog output to match the corresponding pressure displayed on CG1 or CG2 pressure measurement display.

Example

The VGC083CANALOG OUTPUT 1 is programmed for "CG1 1 - 8V". The VGC083 CG1 display is registering a pressure reading of 7.60E+02 Torr. Based on the equation and table given in section 7.7 the expected analog output at 7.60E+02 Torr is 7.881 V. Use the UP or DOWN keys in the AOUT CAL 1 screen to set the analog output to 7.881 V as recorded by your voltmeter. Alternatively, if the CG1 analog output is used to display the CG1 pressure on your PLC or system display console, simply adjust the AOUT CAL 1 while the gauge is exposed to atmosphere so that the CG1 atmospheric pressure displayed by your PLC matches the CG1 atmospheric pressure displayed by the VGC083C. The AOUT CAL can be performed at any pressure between 400 Torr to 999 Torr (atmosphere recommended). Note - As you adjust the analog output, the number being displayed in the AOUT

CAL 1 screen represents the millivolts offset from zero volts that is being used internally for the analog output gain adjustment.

To perform AOUT CAL 1 adjustment if ANALOG OUTPUT 1 is programmed for ALT LINEAR: Connect the CDG to the VGC083C and connect the VGC083C analog output 1 to a high resolution voltmeter, your system, PLC, etc. While in the AOUT CAL 1 screen and with the 1000 TORR CDG exposed to atmosphere, use the UP or DOWN keys to adjust the analog output to match the corresponding pressure displayed for the alternate gauge (CG2/ALT display channel).

Example: The VGC083C ANALOG OUTPUT 1 is programmed for "ALT LINEAR" and a 1000 TORR CDG is connected to the VGC083C. The VGC083C CG2/ALT display channel is registering a pressure reading of 7.60E02 Torr. For a 1000 TORR CDG with a 0-10 VDC output, the expected analog output at 760 Torr is 7.60 volts. Use the UP or DOWN keys in the AOUT CAL 1 screen to set the analog output to 7.60 V as recorded by your voltmeter. Alternatively, if the alternate gauge analog output is used to display the pressure on your PLC or system display console, simply adjust the AOUT CAL 1 while the gauge is exposed to atmosphere so that the alternate gauge atmospheric pressure displayed by your PLC matches the atmospheric pressure displayed by the CG2/ALT display channel of the VGC083C.

For other CDG ranges always use CDG's full scale pressure value to perform calibration. For example, if you are using a 100 TORR CDG, evacuate your system pressure to 100 Torr and use the same calibration procedure described above.

Note - As you adjust the analog output, the number being displayed in the AOUT CAL 1 screen represents the millivolts offset from zero volts that is being used internally for the analog output gain adjustment.

AOUT CAL 2 [Factory default = Factory Set]
(Same info as AOUT CAL 1 above, except for AOUT CAL 2)

AOUT CAL 3 [Factory default = Factory Set]
(Same info as AOUT CAL 1 above, except for AOUT CAL 3)

AOUT LIN 1 [Factory default = 1.00E00 TORR]
This programming parameter is only used if you have assigned IG LINEAR, CG1 LINEAR or CG2 LINEAR to ANALOG OUTPUT 1 above. This analog output type provides a 0-10 Vdc output signal that has a direct linear relationship to the displayed pressure measured by the IG, CG1 or CG2. The AOUT LIN 1 value programmed here represents the maximum pressure as measured by the IG, CG1 or CG2 corresponding to a voltage output of 10 volts. This selection covers, at most, a 3 decade range of pressure.
For example, if AOUT LIN 1 is programmed for 1.00E-03 Torr, then the instrument provides a 10 volt analog output signal when pressure is at 1.00E-03 Torr. Thereafter, minimum pressure is automatically set to 1.00E-06 Torr, with a corresponding minimum voltage output of 0.01 volts. If your application requires the IG, CG1 or CG2 analog output voltage to cover a pressure range exceeding three decades, then consider using the log-linear analog outputs. Refer to section 7.6 and section 7.10 for details regarding this type of output signal.

AOUT LIN 2 [Factory default = 1.00E00 TORR]
(Same info as AOUT LIN 1 above, except for AOUT LIN 2)

AOUT LIN 3 [Factory default = 1.00E00 TORR]
(Same info as AOUT LIN 1 above, except for AOUT LIN 3)

6.5.6 SERIAL COMM

The VGC083C provides both RS232 and RS485 serial communications. Press the ENTER key to access the SERIAL COMM menu for configuring the serial communications.

COMM TYPE

[Factory default = RS485]

The VGC083C supports four different protocols listed below (See section 9 for details).

- RS485 RS485 with start and stop characters and address, derived from INFICON BAG302
- RS232 RS232 with start and stop characters, like RS485 above but no address
- GP485 RS485 compatible with Granville-Phillips 307 and 358 controllers
- GP232 RS232 compatible with Granville-Phillips 307 and 358 controllers

BAUDRATE

[Factory default = 19200]

This sets the baud rate for the RS485 and the RS232 serial communications. The baud rate can be set to various values listed below.

- 38400 BAUD
- 19200 BAUD
- 9600 BAUD
- 4800 BAUD
- 2400 BAUD
- 1200 BAUD
- 600 BAUD
- 300 BAUD

FRAMING

[Factory default = 8 BITS, NONE 1]

This sets the character framing by providing the user various selections to control the number of characters, parity and number of stop bits. Character framing can be set to one of the following.

- 8 BITS NONE 1 (This selection sets the character framing to 8 data bits, no parity, 1 stop bit)
- 7 BITS ODD 2
- 7 BITS EVEN 2
- 7 BITS ODD 1
- 7 BITS EVEN 1
- 8 BITS ODD 1
- 8 BITS EVEN 1

ADDRESS

[Factory default = 01]

This sets the two byte RS485 device address. For example, an ADDRESS of 05 will make the address 0x05 in hexadecimal. An address of 15 will set the ADDRESS to 0x15 in hexadecimal.

6.5.7 DISPLAY

The DISPLAY menu allows the user to configure the OLED setup screen. The user can configure the set-up screen to normal or research mode for IG, enable or disable screen saver and adjust the display intensity. Press the ENTER key to access the DISPLAY menu for configuring the setup screen.

SCREEN SETUP

[Factory default = NORMAL]

This menu configures the display mode for the setup screen. The setup screen can be configured to display the IG parameters in NORMAL or RESEARCH mode. Use the UP and DOWN keys to select the desired setup screen mode from the following menu choices.

- NORMAL Normal display mode for IG
- RESEARCH Research display mode for IG

Select "NORMAL" if you would like to configure the setup screen to display the IG parameters in the normal mode shown below.



Relay status indicators for relays 1 thru 6
 Color filled circle = Relay energized
 No color filled circle = Relay not energized

Select "RESEARCH" if you would like to configure the setup screen to display the IG parameters in the research mode shown below. This is particularly helpful when troubleshooting IG issues.

Discharge current
 value (A)

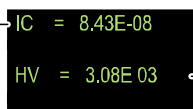

Anode high
 voltage V (dc)

SCREEN SAVER

[Factory default = ON]

The VGC083C set-up screen uses an OLED type display which over an extended period of time can start to show divergence between pixels that are on at all times verses pixels that are not. This could result in pixels exhibiting a burned-in effect. To minimize the burned-in effect, a screen saver function can be activated by programming the SCREEN SAVER menu selection to ON. With the screen saver function turned on, the setup screen changes display appearance every 12 hours. The display will appear in the normal mode with a dark background color for the first 12 hours and will then switch to a back-lit background color for the next 12 hours. If you like to have the 12 hour period for the normal display mode to start at a specific time of the day, simply access the SCREEN SAVER menu and change setting to OFF and then ON again. This initiates the screen saver function immediately.

NOTE To increase longevity of the OLED display, INFICON recommends that the screen saver function remains ON as shipped from the factory.

BRIGHTNESS

[Factory default = 0]

The BRIGHTNESS menu allows the user to select the brightness of the setup screen display. The brightness setting of 0 provides the lowest brightness (contrast) and 10 the highest.

NOTE To increase longevity of the OLED display, INFICON recommends that the brightness function remains at 0 as shipped from the factory.

LED BRIGHTNESS

[Factory default = 8]

Depending on the age of your controller this LED BRIGHTNESS menu may not be available in your product. The LED BRIGHTNESS menu allows the user to select the brightness of the three channel pressure measurement LED displays. The brightness setting of 0 provides the lowest brightness (contrast) and 10 the highest.

7 Analog Output Charts & Equations (Nitrogen/Air Only)

This section provides various charts & equations for analog outputs available from the VGC083C.

7.1 Analog Output wide range measurement for IG - CG1 0.5 - 7V (Nitrogen / Air only)

When the analog output is setup, as described in section 6.5.6 for IG - CG1 / CG2 / ALT 0.5-7V, the analog output voltage represents a combination of the IG and CG1 or IG and CG2 or IG and ALT gauge for wide range measurements. Refer to section 8.3.2 if you are using a gas other than nitrogen/air.

Analog output: Wide Range Log-linear 0.5 to 7 V (dc), 0.5 V per decade

A) The log-linear output signal and pressure are related by the following formulas when units of measurement is in Torr and mbar:

$$P = 10^{(\text{volts} - 5.5)/(0.5)} \quad V = ((0.5 \times \log_{10}(P)) + 5.5)$$

Where P is the pressure in Torr or mbar, and V is the output signal in volts.

B) The log-linear output signal and pressure are related by the following formulas when units of measurement is in pascals:

$$P = 10^{(\text{volts} - 4.5)/(0.5)} \quad V = ((0.5 \times \log_{10}(P)) + 4.5)$$

Where P is the pressure in pascals, and V is the output signal in volts.

Note: The output voltage will switch to above +11 V (dc) under the following conditions:

- 1) The IG sensor is turned off, any IG fault condition and the CG1 is damaged or disconnected.
- 2) The pressure exceeds the value of OVER PRESSURE menu for MAG050 / MAG060 and CG1 is damaged or disconnected.
- 3) Any IG or CG faults condition while operating in the IG or CG range respectively.

Pressure [Torr]	Voltage [V (dc)]
1.00E-10	0.5
1.00E-9	1.0
1.00E-8	1.5
1.00E-7	2.0
1.00E-6	2.5
1.00E-5	3.0
1.00E-4	3.5
1.00E-3	4.0
1.00E-2	4.5
1.00E-1	5.0
1.00E+00	5.5
1.00E+01	6.0
1.00E+02	6.5
1.00E+03	7.0
see notes	≥11

The following chart shows the graphical results of table and formulas above for pressure measurements in Torr. Pressure is plotted on the X-axis with a log scale; the output signal is plotted on the Y-axis on a linear scale.

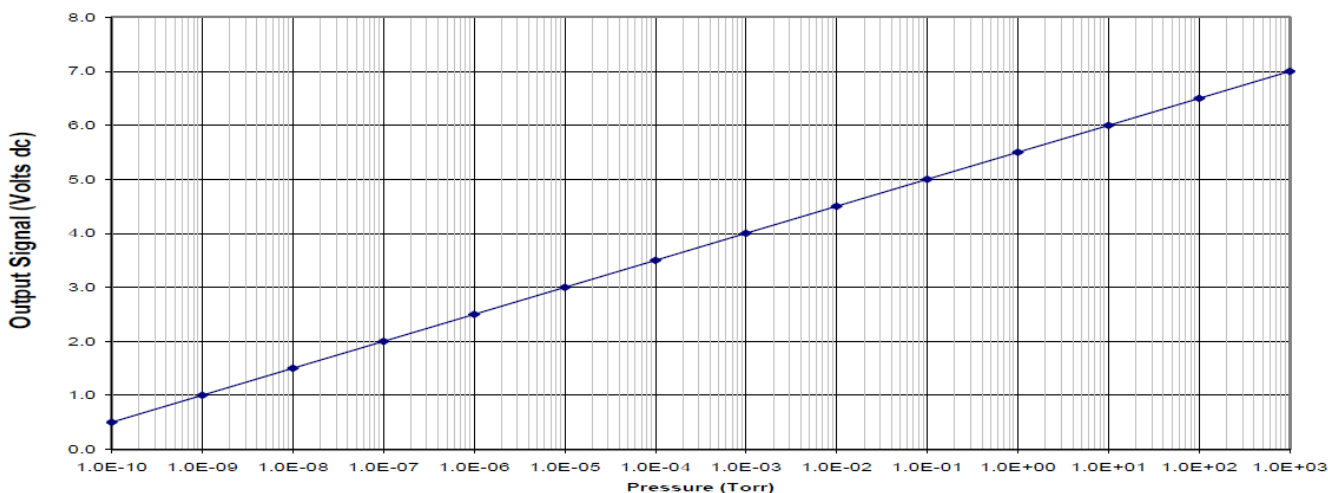

7.2 Analog Output for IG LOG N - 10 (Nitrogen / Air only)

When the analog output is setup, as described in section 6.5.6 for IG LOG N - 10, the analog output voltage represents the pressured measured by the IG for nitrogen/air only. Refer to section 8.3.1 if you are using a gas other than nitrogen/air.

Analog output: IG Log-linear 0 to 9 V (dc), 1 V per decade

A) The log-linear output signal and pressure are related by the following formulas when units of measurement is in Torr and mbar:

$$P = 10^{(V - 10)} \quad V = \log_{10}(P) + 10$$

Where P is the pressure in Torr or mbar, and V is the output signal in volts.

B) The log-linear output signal and pressure are related by the following formulas when units of measurement is in pascals:

$$P = 10^{(V - 8)} \quad V = \log_{10}(P) + 8$$

Where P is the pressure in pascals, and V is the output signal in volts.

Pressure [Torr]	Voltage [V (dc)]
1.00E-10	0.0
1.00E-9	1.0
1.00E-8	2.0
1.00E-7	3.0
1.00E-6	4.0
1.00E-5	5.0
1.00E-4	6.0
1.00E-3	7.0
1.00E-2	8.0
5.00E-2	8.698
see notes	≥11

Note: The output voltage will switch to above +11 V (dc) under the following conditions:

- 1) The IG sensor is turned off or any IG fault condition.

The following chart shows the graphical results of table and formulas above for measurements in Torr. Pressure is plotted on the X-axis with a log scale; the output signal is plotted on the Y-axis on a linear scale.

Log-Linear Analog Voltage to Pressure

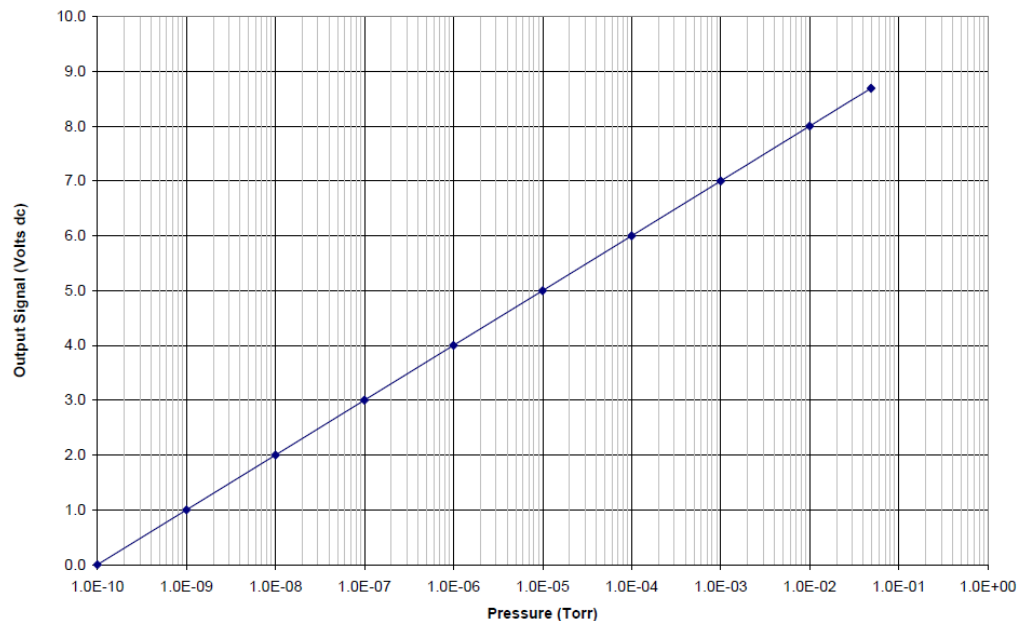

7.3 Analog Output for IG LOG N - 11 (Nitrogen / Air only)

When the analog output is setup, as described in section 6.5.6 for IG LOG N - 11, the analog output voltage represents the pressured measured by the IG for nitrogen/air only. Refer to section 8.3.1 if you are using a gas other than nitrogen/air.

Analog output: IG Log-linear 0 to 10 V (dc), 1 V per decade

A) The log-linear output signal and pressure are related by the following formulas when units of measurement is in Torr and mbar:

$$P = 10^{(\text{volts} - 11)} \quad V = \log_{10}(P) + 11$$

Where P is the pressure in Torr or mbar, and V is the output signal in volts.

B) The log-linear output signal and pressure are related by the following formulas when units of measurement is in pascals:

$$P = 10^{(\text{volts} - 9)} \quad V = \log_{10}(P) + 9$$

Where P is the pressure in pascals, and V is the output signal in volts.

Note: The output voltage will switch to above +11 V (dc) under the following conditions:

- 1) The IG sensor is turned off or any IG fault condition.

Pressure [Torr]	Voltage [V (dc)]
1.00E-11	0.0
1.00E-10	1.0
1.00E-9	2.0
1.00E-8	3.0
1.00E-7	4.0
1.00E-6	5.0
1.00E-5	6.0
1.00E-4	7.0
1.00E-3	8.0
1.00E-2	9.0
5.00E-2	9.698
see notes	≥11

The following chart shows the graphical results of table and formulas above for pressure measurements in Torr. Pressure is plotted on the X-axis with a log scale; the output signal is plotted on the Y-axis on a linear scale.

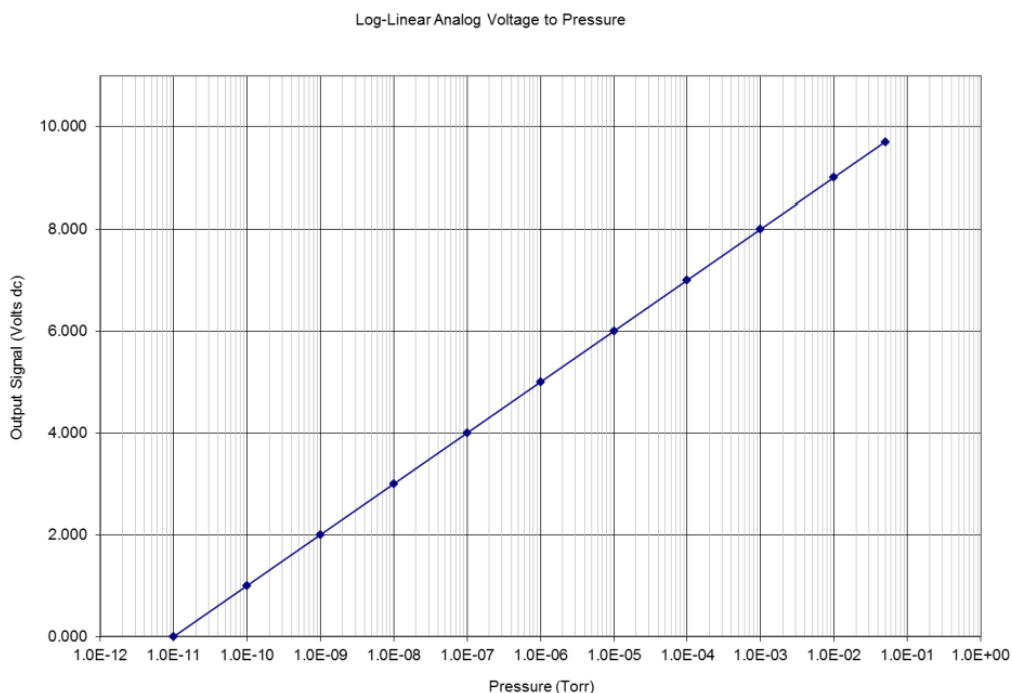

7.4 Analog Output for IG LOG N - 12 (Nitrogen / Air only)

When the analog output is setup, as described in section 6.5.6 for IG LOG N - 12, the analog output voltage represents the pressured measured by the IG for nitrogen/air only. Refer to section 8.3.1 if you are using a gas other than nitrogen/air.

Analog output: IG Log-linear 0 to 11 V (dc), 1 V per decade

A) The log-linear output signal and pressure are related by the following formulas when units of measurement is in Torr and mbar:

$$P = 10^{(\text{volts} - 12)} \quad V = \log_{10}(P) + 12$$

Where P is the pressure in Torr or mbar, and V is the output signal in volts.

B) The log-linear output signal and pressure are related by the following formulas when units of measurement is in pascals:

$$P = 10^{(\text{volts} - 10)} \quad V = \log_{10}(P) + 10$$

Where P is the pressure in pascals, and V is the output signal in volts.

Note: The output voltage will switch to above +11 V (dc) under the following conditions:

- 1) The IG sensor is turned off or any IG fault condition.

Pressure [Torr]	Voltage [V (dc)]
1.00E-12	0.0
1.00E-11	1.0
1.00E-10	2.0
1.00E-9	3.0
1.00E-8	4.0
1.00E-7	5.0
1.00E-6	6.0
1.00E-5	7.0
1.00E-4	8.0
1.00E-3	9.0
1.00E-2	10.0
5.00E-2	10.698
see notes	≥11

The following chart shows the graphical results of table and formulas above for pressure measurements in Torr. Pressure is plotted on the X-axis with a log scale; the output signal is plotted on the Y-axis on a linear scale.

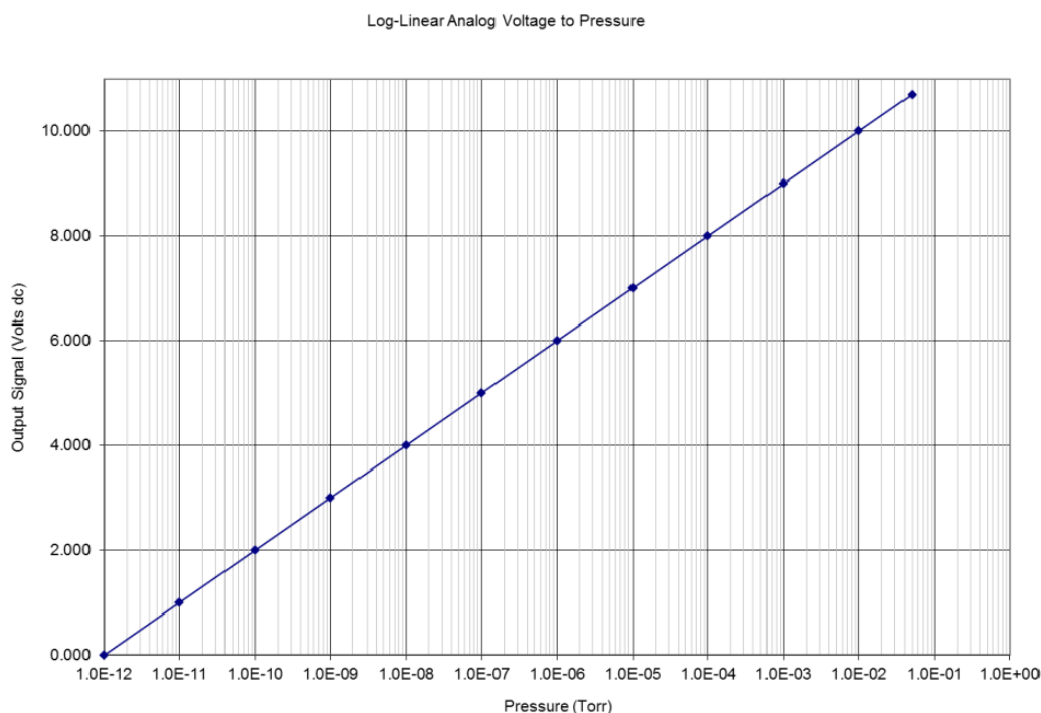

7.5 Analog Output for IG 1.8 - 8.7 V (Nitrogen / Air only)

When the analog output is setup, as described in section 6.5.6, for IG 1.8 – 8.7V, the analog output voltage represents the pressured measured by the IG for nitrogen/air only. Refer to section 8.3.1 if you are using a gas other than nitrogen/air.

Analog output: IG Log-linear 0 to 9.259 Vdc, 0.8 V per decade

The log-linear output signal and pressure are related by the following formulas:

$$P \text{ (Torr)} = 10^{((1.25 \cdot \text{volts}) - 12.875)} \quad V = 10.3 + (0.8) \times \log_{10}(P)$$

$$P \text{ (mbar)} = 10^{((1.25 \cdot \text{volts}) - 12.75)} \quad V = 10.2 + (0.8) \times \log_{10}(P)$$

$$P \text{ (pascals)} = 10^{((1.25 \cdot \text{volts}) - 10.75)} \quad V = 8.6 + (0.8) \times \log_{10}(P)$$

Where P is the pressure and V is the output signal in volts.

Note: The output voltage will switch to above +11 V (dc) under the following conditions:

- 1) The IG sensor is turned off or any IG fault condition.

Pressure [Torr]	Voltage [V (dc)]
2.00E-11	1.741
4.20E-11	2.0
7.50E-10	3.0
1.30E-8	4.0
2.40E-7	5.0
4.20E-6	6.0
7.50E-5	7.0
1.30E-3	8.0
5.00E-2	9.698
filament is OFF	≥11

The following chart shows the graphical results of table and formulas above for pressure measurements in Torr. Pressure is plotted on the X-axis with a log scale; the output signal is plotted on the Y-axis on a linear scale.

Log-Linear Analog Voltage to Pressure

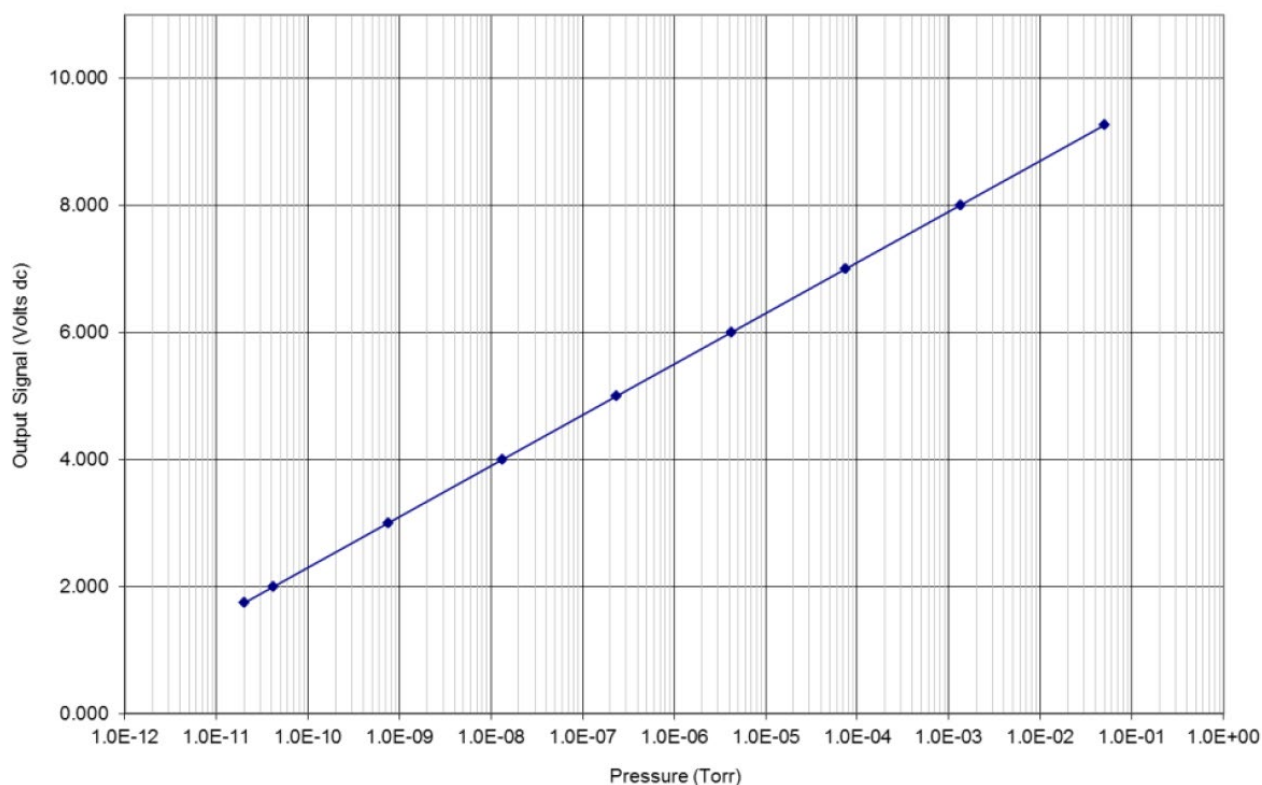

7.6 Analog Output for IG LINEAR (Nitrogen / Air only)

When the analog output is setup, as described in section 6.5.6, for IG LINEAR, the analog output voltage represents the pressure measured by the IG for nitrogen/air only. The Linear analog output type provides a 0-10 V (dc) output signal that has a direct linear relationship to the displayed pressure measured by the ion gauge only. This selection covers 3 decades of pressure change. For example, if ANALOG OUT 1 is programmed for IG LINEAR and the maximum pressure for AOUT LIN 1 selected is 1.00E-03 Torr, then the instrument provides a 10 volt analog output signal when pressure as measured by IG is at 1.00E-03 Torr. Furthermore, the minimum pressure is automatically set to 1.00E-06 Torr, with a corresponding minimum voltage output of 0.01 volts.

Constructing a table of these parameters may be useful in documenting the relationship of displayed pressure (measured by the IG) to the analog output voltage. The following table is representative of a typical setup where the IG may be used in a limited range of pressure measurement where a direct linear relationship exists between the displayed pressure (mantissa) and the analog output signal.

Linear Analog Output Voltage - volts	Measured (Displayed) Pressure - Torr
0.01	1.00E-06
0.10	1.00E-05
1.00	1.00E-04
10.00	1.00E-03

If your application requires the analog output voltage to cover a pressure range exceeding three decades, then consider using a log-linear analog output type for the IG.

NOTE

The information discussed above regarding the Linear IG analog output applies only to N₂ / air. If you are using a gas other than N₂ / air, refer to section 8.3.1 to obtain the true pressure of the specific gas in your vacuum chamber.

Note: The output voltage will switch to above +11 V (dc) under the following conditions:

- 1) The IG sensor is turned off or any IG fault condition.

7.7 Analog Output for CG1 or CG2 1 - 8 V (Nitrogen / Air only)

When the analog output is setup, as described in section 6.5.6, for CG1 1 – 8 V or CG2 1 – 8 V, the analog output voltage represents the pressure measured by CG1 or CG2 for nitrogen/air only. Refer to section 8.3.3.1 if you are using a gas other than nitrogen/air.

Analog output: Convection Gauge Log-linear 1 to 8 V (dc), 1 V per decade

A) The log-linear output signal and pressure are related by the following formulas when units of measurement is in Torr and mbar:

$$P = 10^{(\text{volts} - 5)} \quad V = \log_{10}(P) + 5$$

Where P is the pressure in Torr or mbar, and V is the output signal in volts.

The output voltage is 1 V when pressure is at 1.00E-04 Torr.

The output voltage is 8 V when pressure is at 1.00E+03 Torr.

B) The log-linear output signal and pressure are related by the following formulas when units of measurement is in pascals:

$$P = 10^{(\text{volts} - 3)} \quad V = \log_{10}(P) + 3$$

Where P is the pressure in pascals, and V is the output signal in volts.

Note: An analog output of above +11 volts indicates a faulty convection gauge or unplugged gauge cable.

Pressure [Torr]	Voltage [V]	Pressure [Torr]	Voltage [V]	Pressure [Torr]	Voltage [V]
1.00E-04	1.000	2.00E-01	4.301	3.00E+02	7.477
2.00E-04	1.301	5.00E-01	4.699	4.00E+02	7.602
5.00E-04	1.699	1.00E+00	5.000	5.00E+02	7.699
1.00E-03	2.000	2.00E+00	5.301	6.00E+02	7.778
2.00E-03	2.301	5.00E+00	5.699	7.00E+02	7.845
5.00E-03	2.699	1.00E+01	6.000	7.60E+02	7.881
1.00E-02	3.000	2.00E+01	6.301	8.00E+02	7.903
2.00E-02	3.301	5.00E+01	6.699	9.00E+02	7.954
5.00E-02	3.699	1.00E+02	7.000	1.00E+03	8.000
1.00E-01	4.000	2.00E+02	7.301		

The following chart shows the graphical results of table and formulas above for pressure measurements in Torr.

Log-Linear Analog Voltage to Pressure

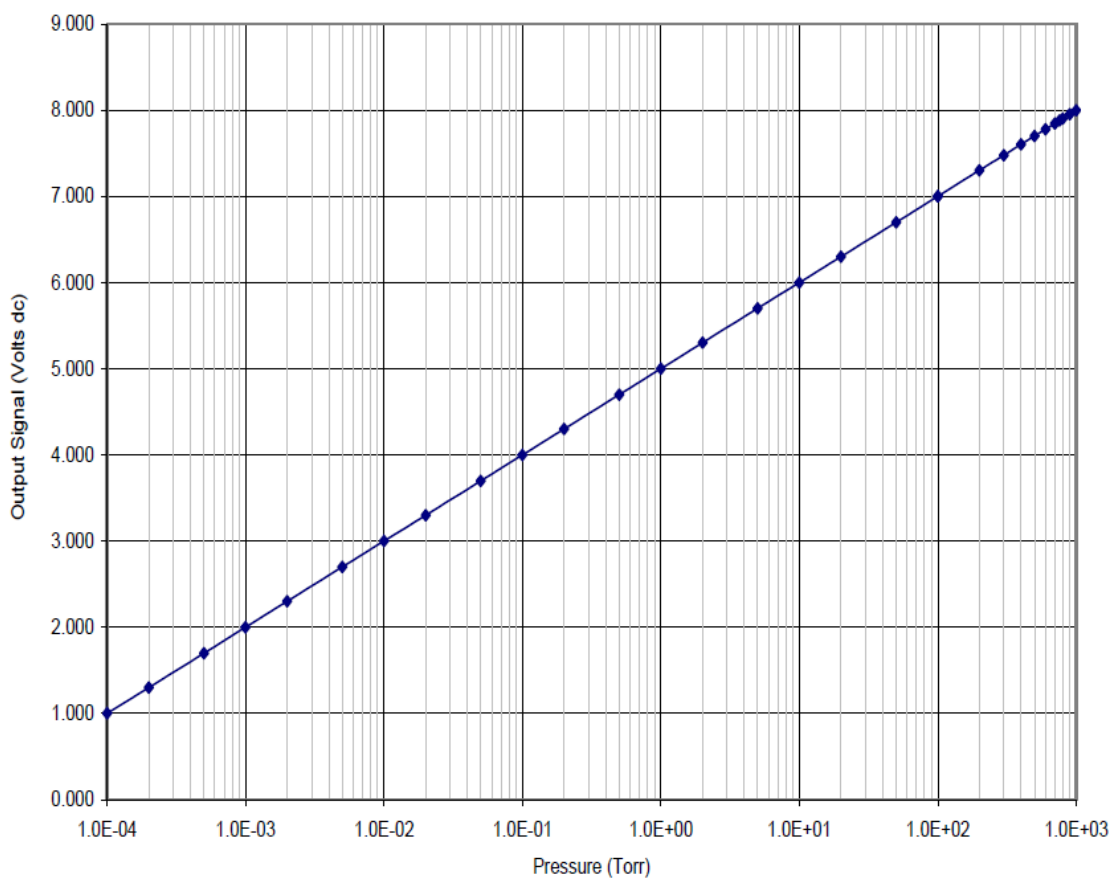

7.8 Analog Output for CG1 or CG2 0 - 7 V (Nitrogen / Air only)

When the analog output is setup, as described in section 6.5.6, for CG1 0 – 7 V or CG2 0 – 7 V, the analog output voltage represents the pressure measured by CG1 or CG2 for nitrogen/air only. Refer to section 8.3.3.2 if you are using a gas other than nitrogen/air.

Analog output: Convection Gauge Log-linear 0 to 7 V (dc), 1 V per decade

A) The log-linear output signal and pressure are related by the following formulas when units of measurement is in Torr and mbar:

$$P = 10^{(\text{volts} - 4)} \quad V = \log_{10}(P) + 4$$

Where P is the pressure in Torr or mbar, and V is the output signal in volts.

The output voltage is 0 V when pressure is at 1.00E-04 Torr.

The output voltage is 7 V when pressure is at 1.00E+03 Torr.

B) The log-linear output signal and pressure are related by the following formulas when units of measurement is in pascals:

$$P = 10^{(\text{volts} - 2)} \quad V = \log_{10}(P) + 2$$

Where P is the pressure in pascals, and V is the output signal in volts.

Note: An analog output of above +11 volts indicates a faulty convection gauge or unplugged gauge cable.

Pressure [Torr]	Voltage [V]	Pressure [Torr]	Voltage [V]	Pressure [Torr]	Voltage [V]
1.00E-04	0.000	2.00E-01	3.300	3.00E+02	6.480
2.00E-04	0.301	5.00E-01	3.700	4.00E+02	6.600
5.00E-04	0.699	1.00E+00	4.000	5.00E+02	6.700
1.00E-03	1.000	2.00E+00	4.300	6.00E+02	6.780
2.00E-03	1.300	5.00E+00	4.700	7.00E+02	6.850
5.00E-03	1.700	1.00E+01	5.000	7.60E+02	6.880
1.00E-02	2.000	2.00E+01	5.300	8.00E+02	6.900
2.00E-02	2.300	5.00E+01	5.700	9.00E+02	6.950
5.00E-02	2.700	1.00E+02	6.000	1.00E+03	7.000
1.00E-01	3.000	2.00E+02	6.300		

The following chart shows the graphical results of table and formulas above for measurements in Torr.

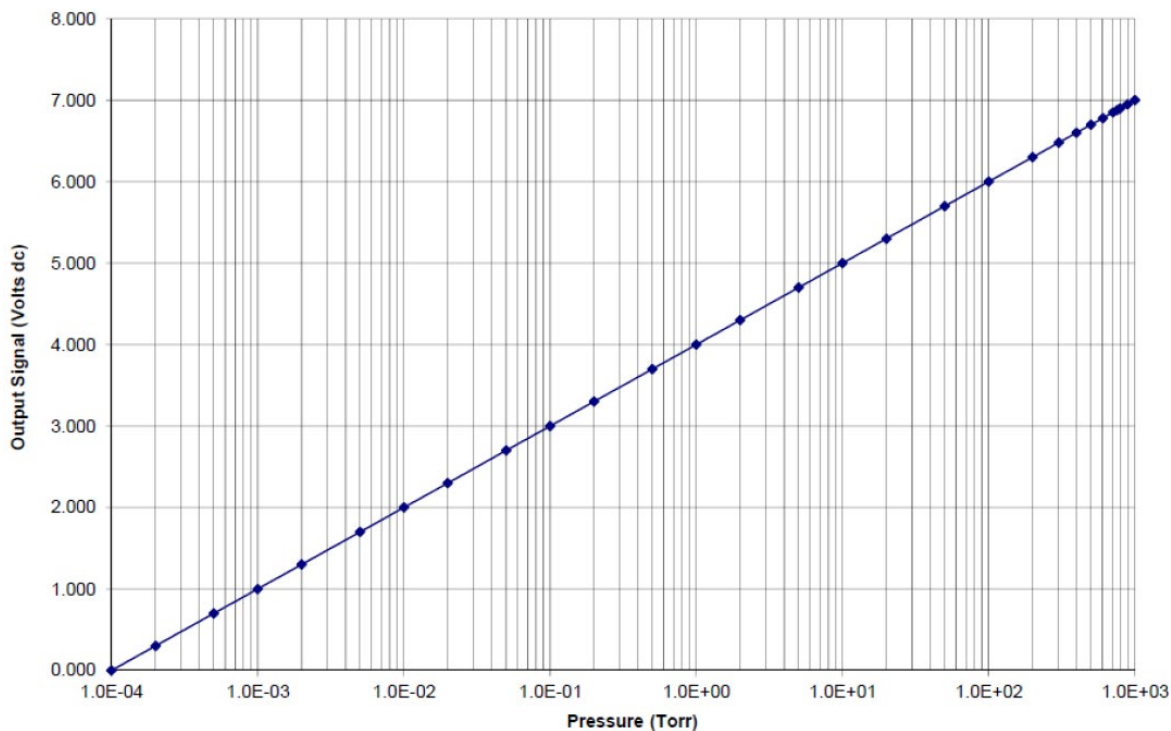

7.9 Analog Output for CG1 or CG2 NON - LIN (Nitrogen / Air only)

When the analog output is setup, as described in section 6.5.6, for CG1 NON - LIN or CG2 NON - LIN, the analog output voltage represents the pressure measured by CG1 or CG2 for nitrogen/air only. Refer to section 8.3.3.3 if you are using a gas other than nitrogen/air.

The first convection enhanced pirani head introduced was the Convector®. The controller for the Convector® provided an analog output signal referred to as the "S-curve" which represented the actual voltage applied across the head circuit, proportional to the pressure inside the pressure head enclosure. The Granville-Phillips® Convector® controllers were designed to output this head voltage and in later years, the non-linear voltage applied to the head was scaled to provide various signal spans of the original "S-curve". The non-linear analog output of the VGC083C duplicates the original S-curve of 0.375 volts at pressure less than 1.00×10^{-4} Torr to 5.659 volts at 1000 Torr, nitrogen or air.

In general, one may use linear interpolation techniques to calculate the pressure using the non-linear analog output voltage measured at a specific pressure. You may also calculate the N₂/air pressure represented by the non-linear analog output voltage for the original "S-curve" using a multi-segment, nth order polynomial function calculation listed on the following page.

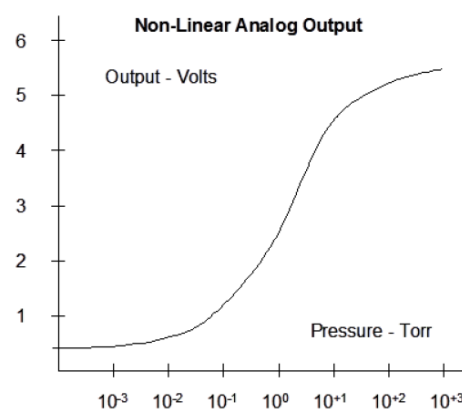

Pressure [Torr]	Voltage [V]	Pressure [Torr]	Voltage [V]	Pressure [Torr]	Voltage [V]
0.000	0.3751	1.00E-01	0.8780	2.00E+02	5.0190
1.00E-04	0.3759	2.00E-01	1.1552	3.00E+02	5.1111
2.00E-04	0.3768	5.00E-01	1.6833	4.00E+02	5.2236
5.00E-04	0.3795	1.00E+00	2.2168	5.00E+02	5.3294
1.00E-03	0.3840	2.00E+00	2.8418	6.00E+02	5.4194
2.00E-03	0.3927	5.00E+00	3.6753	7.00E+02	5.4949
5.00E-03	0.4174	1.00E+01	4.2056	7.60E+02	5.5340
1.00E-02	0.4555	2.00E+01	4.5766	8.00E+02	5.5581
2.00E-02	0.5226	5.00E+01	4.8464	9.00E+02	5.6141
5.00E-02	0.6819	1.00E+02	4.9449	1.00E+03	5.6593

Note - An analog output of above +11 volts indicates a faulty convection gauge or unplugged gauge cable.

The equations and coefficients for the nth order polynomial equation defined for various pressure measurement ranges for the Non-linear analog output (S-curve) for CG1 or CG2 for N₂/air described above are given in the following table:

For **0 mTorr to about 2 Torr**, the Non-Linear Analog Output voltage range of **0.375 to 2.842 volts**, use this table.

Coefficients for $y(x) = a + bx + cx^2 + dx^3 + ex^4 + fx^5$	
a	-0.02585
b	0.03767
c	0.04563
d	0.1151
e	-0.04158
f	0.008738

For **2 Torr to about 100 Torr**, the Non-Linear Analog Output voltage range of **2.842 to 4.945 volts**, use this table.

Coefficients for $y(x) = \frac{a+cx+ex^2}{1+bx+dx^2+fx^3}$	
a	0.1031
b	-0.3986
c	-0.02322
d	0.07438
e	0.07229
f	-0.006866

For **100 Torr to 1000 Torr**, the Non-Linear Analog Output voltage range of **4.94 to 5.659 volts**, use this table.

Coefficients for $y(x) = \frac{a+cx}{1+bx+dx^2}$	
a	100.624
b	-0.37679
c	-20.5623
d	0.0348656

Where $y(x)$ = pressure in Torr, x = measured analog output in volts

Example: Measured analog output voltage is 0.3840 V.

From first table shown above use equation:

$$y(x) = a + bx + cx^2 + dx^3 + ex^4 + fx^5$$

$$x = 0.3840 \text{ volts}$$

$$a = -0.02585, \quad b=0.03767, \quad c=0.04563, \quad d=0.1151, \quad e=-0.04158, \quad f=0.008738$$

$$y(x) = \text{Pressure} = 1.0\text{E-}03 \text{ Torr}$$

7.10 Analog Output for CG1 or CG2 LINEAR (Nitrogen / Air only)

When the analog output is setup, as described in section 6.5.5 , for CG1 LINEAR or CG2 LINEAR, the analog output voltage represents the pressure measured by the CG1 or CG2 for nitrogen/air only. The Linear analog output type provides a 0-10 V (dc) output signal that has a direct linear relationship to the displayed pressure measured by the CG1 or CG2 only. This selection covers 3 decades of pressure change. For example, if ANALOG OUT 1 is programmed for CG1 LINEAR and the maximum pressure for AOUT LIN 1 selected is 1.00 Torr, then the instrument provides a 10 volt analog output signal when pressure as measured by CG1 is at 1.00 Torr. Furthermore, the minimum pressure is automatically set to 1.00E-03 Torr, with a corresponding minimum voltage output of 0.01 volts.

Constructing a table of these parameters may be useful in documenting the relationship of displayed pressure (measured by the IG) to the analog output voltage. The following table is representative of a typical setup where the CG may be used in a limited range of pressure measurement where a direct linear relationship exists between the displayed pressure (mantissa) and the analog output signal.

Linear Analog Output Voltage - volts	Measured (Displayed) Pressure - Torr
0.01	1.00E-03
0.10	1.00E-02
1.00	1.00E-01
10.00	1.00E+00

If your application requires the analog output voltage to cover a pressure range exceeding three decades, then consider using a log-linear analog output type for CG1 or CG2.

Note - An analog output of above +11 volts indicates a faulty convection gauge or unplugged gauge cable.

8 Using the Gauge with Different Gases

The following tables and explanation contain important information regarding the use of ionization and convection gauges when used to measure pressure of gases other than nitrogen /air. For both types of gauge heads, corrections must be applied to both the display and analog outputs. This is particularly critical when using convection gauges at higher pressures than measured by the ion gauge when using gases other than N₂/air.

8.1 Ion Gauge Display Correction Factors for Selected Gases

The measurement value is gas dependent. The pressure reading applies to dry air, O₂, CO and N₂. For other gases, the measurements have to be corrected. There are two methods that can be used for monitoring the IG display when using gases other than nitrogen/air:

1) If you are using a gas other than N₂ / air, you must manually apply a gas correction factor to the IG displayed measurement. Post a label on your ion gauge display showing the correction factor to be used for the pressure of the gas type you are measuring. The table below provides typical correction factors (k) for cold cathode ion gauges when used with various gas. To correct the display measurements, multiply the displayed measured pressure by the correction factor for the gas type you are measuring:

Indicated pressure (gauge calibrated for air/N₂)

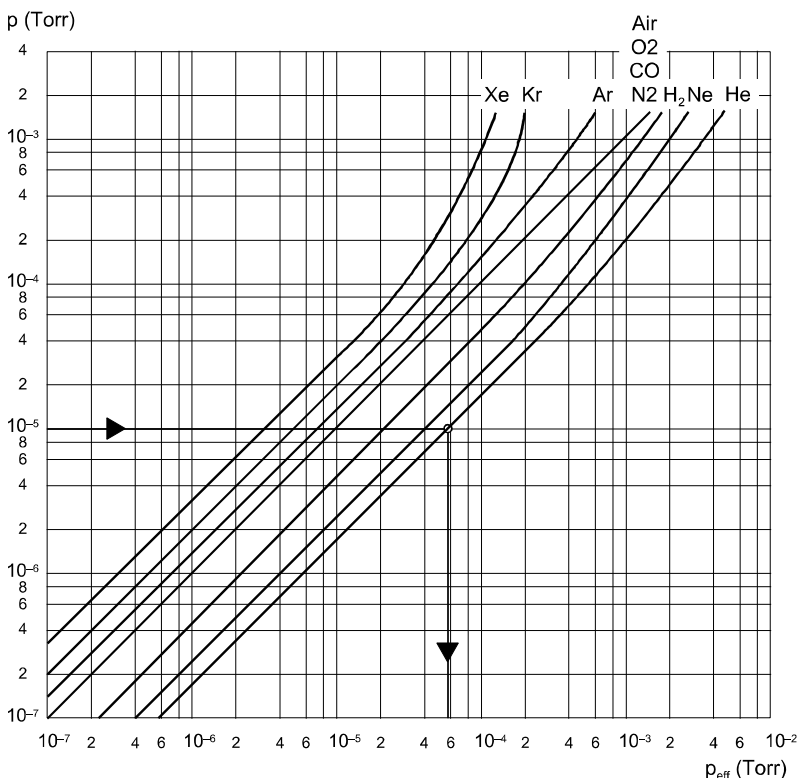

In the range below 10⁻⁵ Torr the pressure indication is linear. For gases other than air / N₂, the pressure can be determined by means of the following conversion formula:

$$p_{\text{eff}} = K \times \text{indicated pressure}$$

where:

Gas type	K	Gas type	K
Air (N ₂ , O ₂ , CO)	1.0	H ₂	2.4
Xe	0.4	Ne	4.1
Kr	0.5	He	5,9
Ar	0.8		

These gas correction factors are average values.

Example

If the gas in use is argon (Ar) and the VGC083C controller indicates a measured pressure of 7.6×10^{-6} Torr:

$$p_{\text{eff}} = 0.8 \times 7.60 \times 10^{-6} = 6.08 \times 10^{-7} \text{ Torr true pressure of argon gas}$$

NOTE

Cold cathode gauges exhibit a non-linear response in the pressure range of 1×10^{-4} Torr and higher. This non-linear response is corrected in the controller firmware and calibration for air/N₂. Since this internal correction is applicable to air/N₂ only, it is recommended to use the pressure measurements from the convection gauge when operating in the pressure range of 1×10^{-4} Torr and higher for other gases. With both cold cathode and convection gauges the appropriate gas correction factors must be applied.

2) Alternatively, you may correct the display for a direct reading of pressure for the type of gas you are using by adjusting the sensitivity value for the IG. If you adjust the sensitivity value of your ion gauge to compensate the readout of pressure for a gas type other than nitrogen / air, the displayed pressure readout for that device must be annotated to indicate that the displayed pressure is for the gas type the readout is compensated for.

In the above example, if the sensitivity value of the cold cathode ion gauge being used is 10 Torr⁻¹ ("10 per Torr"), the sensitivity value can be programmed to 12.5 ($10/0.8 = 12.5$) so that the pressure readout would directly indicate the true pressure of argon. Again, the display line for that particular device pressure readout would require annotation (a user applied label) so as to not conflict with the gas type selection/notation of nitrogen (N₂). See Note above for pressure measurements of 1×10^{-4} Torr and higher when using the cold cathode with gases other than air/N₂.

8.2 Effects of Different Gases on Convection Gauge Display

Convection gauge operation is based on the physical effect of thermal conductivity of the gas inside the gauge head. The convection gauge senses heat loss in a sensor wire. This heat loss depends on the thermal conductivity of the gas surrounding the sensor wire. Since different gases, and mixtures, have different thermal conductivities, the indicated pressure readings and outputs will also be different. INFICON convection gauges (and most other thermal, heat loss type gauges) are normally calibrated using nitrogen. When a gas other than N₂ is used, correction must be made for the difference in thermal conductivity between N₂ and the gas in use. The charts and tables below indicate how different gases affect the display from an INFICON convection gauge.

For nitrogen gas (N₂) the calibration of the convection gauge shows excellent agreement between indicated and true pressure throughout the range from 10^{-4} to 1000 Torr. At pressures below about 1 Torr, the calibration curves for the different gases are similar. The difference in readings (between indicated and true pressure) at these low pressures is usually a constant; a function of the difference between thermal conductivities of the gases.

At pressures above about 1 Torr, indicated pressure readings may diverge significantly from true pressure. At these higher pressures, convection currents in the gauge become the predominant cause of heat loss from the sensor. Calibration and performance at pressures higher than about 1 Torr depends on gauge tube geometry and mounting orientation as well as gas properties.

Generally, air and N₂ are considered the same as far as thermal conductivity goes, but even these two gases will exhibit slight differences in readings at higher pressures. For example, when venting a system to atmosphere using N₂, you may see readings change by about 30 to 40 Torr after the chamber is opened and air gradually displaces the N₂ in the gauge. This is due to the partial pressure of oxygen (O₂) contained in atmospheric air.

**Convection Vacuum Gauge
Indicated vs. True Total Pressure
Test Gases - N₂, Ar, He**

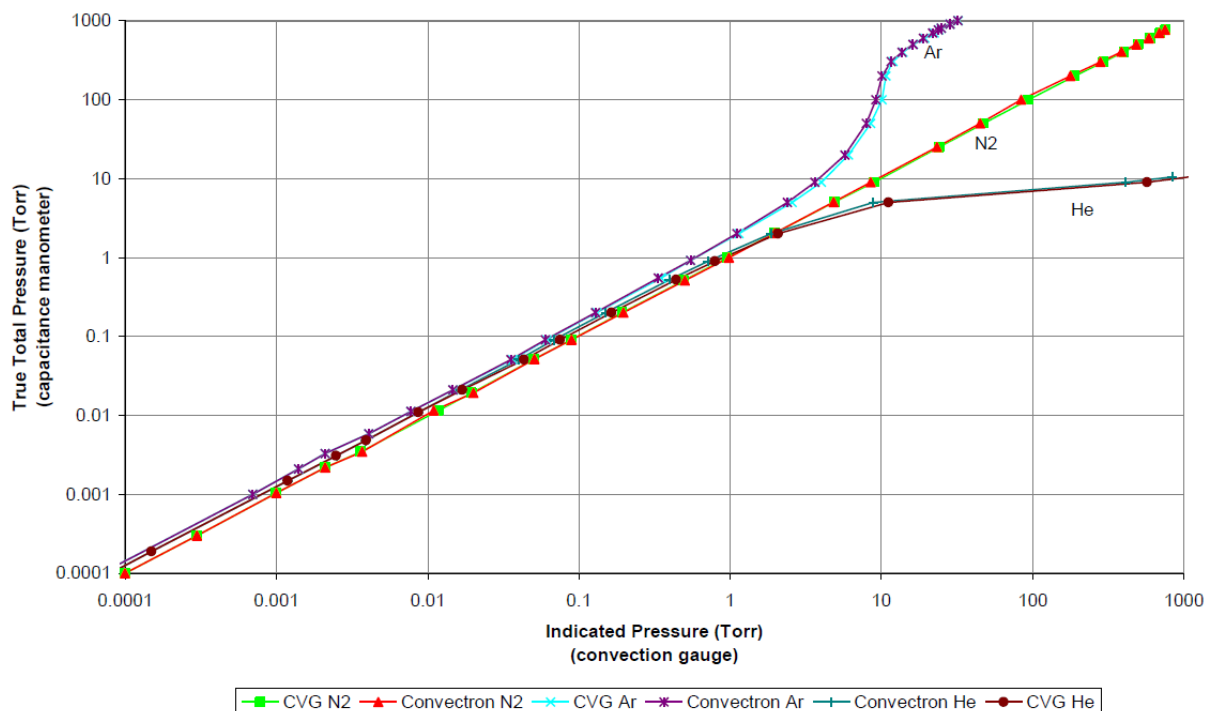

The Y-axis of the above chart is actual pressure as measured by a capacitance manometer, a diaphragm gauge that measures true total pressure independent of gas composition. The X-axis is the pressure reading indicated by the convection gauge under test. This chart shows readings for an INFICON convection gauge (CVG) and Granville-Phillips® Convector® gauge to illustrate that the difference in the response for both of these types of gauges is virtually indistinguishable.

CAUTION!

Do not assume this data applies to other convection gauges which may or may not be the same. See Table 1 below and note the following examples:

Example A

If the gas is nitrogen (N₂), when the true total pressure is 500 Torr, the gauge will read 500 Torr.

Example B

If the gas is argon (Ar), when the true pressure is 100 Torr, the gauge will read about 9 Torr.

If you are backfilling your vacuum system with Ar, when your system reaches a pressure of 760 Torr true pressure your gauge will be reading about 23 Torr. Continuing to backfill your system, attempting to increase the reading up to 760 Torr, you will over pressurize your chamber which may present a hazard.

Example C

If the gas is helium (He), the gauge will read 1.10E+03 (overpressure indication) Torr when pressure reaches about 10 Torr true pressure and opening the chamber to atmosphere prematurely may present other hazards for both people and product. You probably will not cause damage to your vacuum system, but opening the chamber to atmosphere with the internal chamber pressure at only 10 Torr true pressure, may present other hazards for both personnel in the proximity and product that may be inside the chamber/vessel.

CAUTION! What these examples illustrate is that using gases other than nitrogen (N₂) without using accurate gas conversion data and other proper precautions could result in injury to personnel and/or damage to equipment.

Suggested precautions when using gases other than N₂:

- Install a pressure relief valve or burst disk on your chamber to provide protection from the dangers associated with over pressurizing the chamber.
- Post a warning label on your gauge readout such as "Do Not Exceed _____ Torr Indicated Pressure" (fill in the blank for the gas type you are using) so that an operator using the vacuum chamber system and connected gauge will not exceed a safe operating pressure.

CAUTION!  Do not assume this data applies to other convection gauges, which may or may not be the same.

CAUTION!  Risk of over pressurizing a gas containment vessel and attached apparatus exists when using pressure measurement devices that are calibrated for a specific gas type. Use a pressure relief device to safely limit the internal pressure of a containment vessel to less than the maximum allowable working pressure rating for the vacuum/pressure system and all devices attached to the system.

WARNING!  Using a thermal conductivity gauge with gases other than that for which it is calibrated could result in death or serious injury. Be sure to use gas correction data in this manual when measuring pressures of gases other than N₂ / air.

Exercise caution when admitting positive pressures (above local ambient, atmospheric pressure) of gas into any enclosed volume. Install pressure relief devices on your vacuum / pressure vessel or chamber to limit the maximum allowable working pressure inside the devices and vessel internal volume to less than the lowest rated device - in some cases, the maximum allowable working pressure may be dictated by the type of connections or fittings used to attach devices to your chamber. An O-ring compression fitting type device may be forcibly released (ejected) from the fitting if internal pressure exceeds the local barometric, ambient pressure.

The table below shows the convection gauge displayed readings at various pressures for several commonly used gas types:

True Pressure (Torr)	N ₂	Ar	He	O ₂	CO ₂	Kr	Freon12	Freon22	D ₂	Ne	CH ₄
1.00E-4	1.00E-4	1.00E-4	1.00E-4	1.00E-4	1.00E-4	1.00E-4	1.00E-4	1.00E-4	1.00E-4	1.00E-4	1.00E-4
2.00E-4	2.00E-4	2.00E-4	2.00E-4	2.00E-4	2.00E-4	2.00E-4	2.00E-4	2.00E-4	2.00E-4	2.00E-4	2.00E-4
5.00E-4	5.00E-4	5.00E-4	5.00E-4	5.00E-4	5.00E-4	3.00E-4	5.00E-4	5.00E-4	5.00E-4	5.00E-4	5.00E-4
1.00E-3	1.00E-3	7.00E-4	8.00E-4	1.00E-3	1.10E-3	4.00E-4	1.50E-3	1.50E-3	1.30E-3	7.00E-4	1.70E-3
2.00E-3	2.00E-3	1.40E-3	1.60E-3	2.00E-3	2.30E-3	1.00E-3	3.10E-3	3.10E-3	2.40E-3	1.50E-3	3.30E-3
5.00E-3	5.00E-3	3.30E-3	4.00E-3	5.00E-3	4.40E-3	2.30E-3	7.60E-3	7.00E-3	6.00E-3	3.50E-3	7.70E-3
1.00E-2	1.00E-2	6.60E-3	8.10E-3	9.70E-3	1.10E-2	4.80E-3	1.47E-2	1.35E-2	1.21E-2	7.10E-3	1.53E-2
2.00E-2	2.00E-2	1.31E-2	1.61E-2	1.98E-2	2.22E-2	9.50E-3	2.99E-2	2.72E-2	2.43E-2	1.41E-2	3.04E-2
5.00E-2	5.00E-2	3.24E-2	4.05E-2	4.92E-2	5.49E-2	2.35E-2	7.25E-2	6.90E-2	6.00E-2	3.48E-2	7.72E-2
1.00E-1	1.00E-1	6.43E-2	8.20E-2	9.72E-2	1.07E-1	4.68E-2	1.43E-1	1.36E-1	1.21E-1	7.00E-2	1.59E-1
2.00E-1	2.00E-1	1.26E-1	1.65E-1	1.94E-1	2.10E-1	9.11E-2	2.75E-1	2.62E-1	2.50E-1	1.41E-1	3.15E-1
5.00E-1	5.00E-1	3.12E-1	4.35E-1	4.86E-1	4.89E-1	2.17E-1	6.11E-1	5.94E-1	6.87E-1	3.59E-1	7.81E-1
1.00E+0	1.00E+0	6.00E-1	9.40E-1	9.70E-1	9.50E-1	4.00E-1	1.05E+0	1.04E+0	1.55E+0	7.45E-1	1.60E+0
2.00E+0	2.00E+0	1.14E+0	2.22E+0	1.94E+0	1.71E+0	7.00E-1	1.62E+0	1.66E+0	4.13E+0	1.59E+0	3.33E+0
5.00E+0	5.00E+0	2.45E+0	1.35E+1	4.98E+0	3.34E+0	1.28E+0	2.45E+0	2.62E+0	2.46E+2	5.24E+0	7.53E+0
1.00E+1	1.00E+1	4.00E+0	OP	1.03E+1	4.97E+0	1.78E+0	2.96E+0	3.39E+0	OP	2.15E+1	2.79E+1
2.00E+1	2.00E+1	5.80E+0	OP	2.23E+1	6.59E+0	2.29E+0	3.32E+0	3.72E+0	OP	5.84E+2	3.55E+2
5.00E+1	5.00E+1	7.85E+0	OP	7.76E+1	8.22E+0	2.57E+0	3.79E+0	4.14E+0	OP	OP	8.42E+2
1.00E+2	1.00E+2	8.83E+0	OP	2.09E+2	9.25E+0	2.74E+0	4.68E+0	4.91E+0	OP	OP	OP
2.00E+2	2.00E+2	9.79E+0	OP	2.95E+2	1.23E+1	3.32E+0	5.99E+0	6.42E+0	OP	OP	OP
3.00E+2	3.00E+2	1.13E+1	OP	3.80E+2	1.69E+1	3.59E+0	6.89E+0	7.52E+0	OP	OP	OP
4.00E+2	4.00E+2	1.35E+1	OP	4.85E+2	2.24E+1	3.94E+0	7.63E+0	8.42E+0	OP	OP	OP
5.00E+2	5.00E+2	1.61E+1	OP	6.04E+2	2.87E+1	4.21E+0	8.28E+0	9.21E+0	OP	OP	OP
6.00E+2	6.00E+2	1.88E+1	OP	7.30E+2	3.64E+1	4.44E+0	8.86E+0	9.95E+0	OP	OP	OP
7.00E+2	7.00E+2	2.18E+1	OP	8.59E+2	4.61E+1	4.65E+0	9.42E+0	1.07E+1	OP	OP	OP
7.60E+2	7.60E+2	2.37E+1	OP	9.41E+2	5.39E+1	4.75E+0	9.76E+0	1.11E+1	OP	OP	OP
8.00E+2	8.00E+2	2.51E+1	OP	9.97E+2	5.94E+1	4.84E+0	9.95E+0	1.14E+1	OP	OP	OP
9.00E+2	9.00E+2	2.85E+1	OP	OP	7.95E+1	4.99E+0	1.05E+1	1.20E+1	OP	OP	OP
1.00E+3	1.00E+3	3.25E+1	OP	OP	1.11E+2	5.08E+0	1.11E+1	1.27E+1	OP	OP	OP

Values listed under each gas type are in Torr units
Over Pressure (OP)= 1.10E+03 Torr

When using gases other than nitrogen/air, you must use the above look-up table to determine the true pressures of selected gases as measured by convection gauges. For example, if the gas you are using in your vacuum system chamber is predominately argon (Ar), a displayed pressure of 1.14E+00 Torr means the actual true pressure of argon is 2.00E+00 Torr based on the conversion information provided in the above table.

Example: If the gas is argon (Ar), when the true pressure is 100 Torr, the gauge will read only about 9 Torr.

8.3 Effects of Different Gases on Analog Output

The following tables and explanation contains important information regarding the use of ionization and convection gauges on gases other than N₂ / Air. For both types of gauges, corrections must be applied to the analog outputs.

8.3.1 Ion Gauge Analog Output Correction Factors for Selected Gases

When using any of the analog outputs assigned to ion gauge only, use the following steps to convert the analog output to pressure: ion gauge analog output correction factors for selected gases:

- A) Refer to section 7 and use the related equation to convert the voltage in your receiving instrument to pressure. This pressure value is based on nitrogen gas.
- B) Apply the Gas Correction Factor for the particular gas you are using to the pressure value obtained in step A. Use correction factors and example listed below:

In the range below 10⁻⁵ Torr the pressure indication is linear. For gases other than air / N₂, the pressure can be determined by means of the following conversion formula:

$$p_{\text{eff}} = K \times \text{indicated pressure}$$

where:

Gas type	K	Gas type	K
Air (N ₂ , O ₂ , CO)	1.0	H ₂	2.4
Xe	0.4	Ne	4.1
Kr	0.5	He	5,9
Ar	0.8		

These gas correction factors are average values.

Example

ANALOG OUT 1 selected is IG LOG N-10. The gas in use is argon. Voltage output is 4 volts. Pressure unit is Torr.

$$p \text{ (nitrogen)} = 10^{(\text{volts} - 10)}$$

$$p = 10^{(4 - 10)}$$

$$p = 1.00 \times 10^{-6} \text{ Torr (based on nitrogen)}$$

Applying the Gas Correction Factor of 0.8 for argon listed in the table above,

$$p \text{ (argon)} = 0.8 \times 1 \times 10^{-6} = 8 \times 10^{-7} \text{ Torr true pressure of argon gas}$$

NOTE

Cold cathode gauges exhibit a non-linear response in the pressure range of 1×10⁻⁴ Torr and higher. This non-linear response is corrected in the controller firmware and calibration for air/N₂. Since this internal correction is applicable to air/N₂ only, it is recommended to use the pressure measurements from the convection gauge when operating in the pressure range of 1×10⁻⁴ Torr and higher for other gases. With both cold cathode and convection gauges the appropriate gas correction factors must be applied.

8.3.2 IG - CG1 0.5 - 7V Analog Output Correction Factors for Selected Gases

When using the IG - CG1 or IG - CG2 analog output mode (Log-Linear 0.5 - 7 V, 0.5 V/decade) for gases other than air/N₂, the analog output is interpreted differently over two different pressure ranges as discussed below:

- A) Pressure range from high vacuum to the OVER PRESSURE value programmed in the VGC083C (cold cathode ion gauge range):
Use the correction factors listed in section 8.3.2.1 below to determine pressure from the voltage for selected gases (ion gauge range). As discussed previously cold cathode gauges exhibit a non-linear response in the pressure range of 1×10⁻⁴ Torr and higher. This non-linear response is corrected in the controller firmware and calibration for air/N₂. Since this internal correction is applicable to air/N₂ only, it is recommended to use the pressure measurements from the convection gauge when operating in the pressure range of 1×10⁻⁴ Torr and higher for other gases. However in the analog output combination mode IG - CG1 or IG - CG2, the analog output is derived from measurements by the cold cathode gauge over the pressure range of 1×10⁻⁴ Torr to the OVER PRESSURE shut down value. As such, we recommend not using the IG - CG1 or IG - CG2 mode when using gases other than air/N₂. Instead, consider using individual analog outputs for the cold cathode

and the convection gauge and use the measurements from the convection gauge in the range of 1×10^{-4} Torr and higher thus disregarding the pressure measurements from the cold cathode gauge above 1×10^{-4} Torr. With both cold cathode and convection gauges the appropriate gas correction factors must be applied.

B) Pressure range from the ion gauge OVER PRESSURE value programmed in the VGC083C to 1,000 Torr:

Use the correction factors listed in section 8.3.2.2 below to determine pressure from the voltage for selected gases (convection gauge range).

8.3.2.1 IG-CG1 0.5 - 7V Analog Output Correction Factors - Ion Gauge Range

A) When using the IG - CG1 or IG - CG2 analog output mode (Log-Linear 0.5-7 V, 0.5 V/decade) for gases other than air/N₂, use the following steps to convert the analog output to pressure for MAG050/060 when operating from high vacuum to the to OVER PRESSURE shut down value programmed in the VGC083C.

B) Refer to section 7.1 and related equation to convert the voltage in your receiving instrument to pressure. This pressure value is based on nitrogen.

C) Apply the gas correction factor (k) for the particular gas you are using to the pressure value obtained in step A (Use correction factors and example listed below).

In the range below 10^{-5} Torr the pressure indication is linear. For gases other than air / N₂, the pressure can be determined by means of the following conversion formula:

$$p_{\text{eff}} = K \times \text{indicated pressure}$$

where:

Gas type	K	Gas type	K
Air (N ₂ , O ₂ , CO)	1.0	H ₂	2.4
Xe	0.4	Ne	4.1
Kr	0.5	He	5.9
Ar	0.8		

These gas correction factors are average values.

Example

The gas in use is argon. Output voltage is 3 volts. Pressure unit is Torr.

$$p(\text{nitrogen}) = 10^{\frac{\text{volts}-5.5}{0.5}} = 10^{(3.0-5.5)/(0.5)}$$

$$p = 1 \times 10^{-5} \text{ Torr (based on nitrogen)}$$

$$p(\text{argon}) = 0.8 \times 1 \times 10^{-5} = 8 \times 10^{-6} \text{ Torr true pressure of argon gas}$$

As described in section 8.3.2 cold cathode gauges exhibit a non-linear response in the pressure range of 1×10^{-4} Torr and higher. This non-linear response is corrected in the controller firmware and calibration for air/N₂. Since this internal correction is applicable to air/N₂ only, it is recommended to use the pressure measurements from the convection gauge when operating in the pressure range of 1×10^{-4} Torr and higher for other gases. However in the analog output combination mode IG - CG1 or IG - CG2, the analog output is derived from measurements by the cold cathode gauge over the pressure range of 1×10^{-4} Torr to the OVER PRESSURE shut down value. As such, we recommend not using the IG - CG1 or IG - CG2 mode when using gases other than air/N₂. Instead, consider using individual analog outputs for the cold cathode and the convection gauge and use the measurements from the convection gauge in the range of 1×10^{-4} Torr and higher thus disregarding the pressure measurements from the cold cathode gauge above 1×10^{-4} Torr. With both cold cathode and convection gauges the appropriate gas correction factors must be applied.

8.3.2.2 IG-CG1 0.5 - 7V Analog Output Correction Factors - Convection Gauge Range

When using the IG - CG1 or IG - CG2 analog output mode (Log-Linear 0.5 - 7 V, 0.5 V/decade) for gases other than air/N₂, use the following look-up table and information to convert the analog output to pressure when operating in the pressure range of overpressure shutdown value listed in section 5.4 to 1000 Torr. The look-up table has been derived from equation listed in section 7.1.

Analog output IG - CG1 or IG - CG2 when in the pressure range of overpressure shutdown value to 1000 Torr

True Pressure (Torr)	N2	Ar	He	O2	CO2	KR	Freon12	Freon22	D2	Ne	CH ₄
1.00E-3	4.000	3.923	3.952	4.000	4.021	3.801	4.088	4.088	4.057	3.923	4.115
2.00E-3	4.151	4.073	4.102	4.151	4.181	4.000	4.246	4.246	4.190	4.088	4.259
5.00E-3	4.349	4.259	4.301	4.349	4.322	4.181	4.440	4.423	4.389	4.272	4.443
1.00E-2	4.500	4.410	4.454	4.493	4.521	4.341	4.584	4.565	4.541	4.426	4.592
2.00E-2	4.651	4.559	4.603	4.648	4.673	4.489	4.738	4.717	4.693	4.575	4.741
5.00E-2	4.849	4.755	4.804	4.846	4.870	4.686	4.930	4.919	4.889	4.771	4.944
1.00E-1	5.000	4.904	4.957	4.994	5.015	4.835	5.078	5.067	5.041	4.923	5.101
2.00E-1	5.151	5.050	5.109	5.144	5.161	4.980	5.220	5.209	5.199	5.075	5.249
5.00E-1	5.349	5.247	5.319	5.343	5.345	5.168	5.393	5.387	5.418	5.278	5.446
1.00E+0	5.500	5.389	5.487	5.493	5.489	5.301	5.511	5.509	5.595	5.436	5.602
2.00E+0	5.651	5.528	5.673	5.644	5.616	5.423	5.605	5.610	5.808	5.601	5.761
5.00E+0	5.849	5.695	6.065	5.849	5.762	5.554	5.695	5.709	6.695	5.860	5.938
1.00E+1	6.000	5.801		6.006	5.848	5.625	5.736	5.765		6.166	6.223
2.00E+1	6.151	5.882		6.174	5.909	5.680	5.761	5.785		6.883	6.775
5.00E+1	6.349	5.947		6.445	5.957	5.705	5.789	5.809			6.963
1.00E+2	6.500	5.973		6.660	5.983	5.719	5.835	5.846			
2.00E+2	6.651	5.995		6.735	6.045	5.761	5.889	5.904			
3.00E+2	6.739	6.027		6.790	6.114	5.778	5.919	5.938			
4.00E+2	6.801	6.065		6.843	6.175	5.798	5.941	5.963			
5.00E+2	6.849	6.103		6.891	6.229	5.812	5.959	5.982			
6.00E+2	6.889	6.137		6.932	6.281	5.824	5.974	5.999			
7.00E+2	6.923	6.169		6.967	6.332	5.834	5.987	6.015			
7.60E+2	6.940	6.187		6.987	6.366	5.838	5.995	6.023			
8.00E+2	6.952	6.200		6.999	6.387	5.842	5.999	6.028			
9.00E+2	6.977	6.227			6.450	5.849	6.011	6.040			
1.00E+3	7.000	6.256			6.523	5.853	6.023	6.052			

Values listed under each gas type are in volts (V).

Example

The gas in use is O₂. Voltage output is 5.144 volts.
True pressure of O₂ is 2.00E-01 Torr

NOTE

If you are using the IG - ALT 0.5 - 7V analog output mode refer to the User Manual of your alternate gauge to determine the correction factors for various gases.

8.3.3 Convection gauge analog output for selected gases

If you intend to use any of the analog outputs to represent measurements from CG1 or CG2 for gases other than air/N₂, you must also apply corrections to the analog output. Use the following tables to determine pressure from voltage for gases other than nitrogen or air.

8.3.3.1 CG1 1 - 8 V or CG2 1 - 8 V Analog Output Correction Factors - Convection Gauge

When using the Log-Linear convection gauge analog output mode (Log-Linear 1 - 8 V, 1 V/decade) for gases other than air/N₂, use the following look-up table and information to convert the analog output to pressure. The look-up table has been derived from the equation provided in section 7.7

Analog Output for Log-Linear CG1 1-8V or CG2 1-8V

True Pressure (Torr)	N ₂	Ar	He	O ₂	CO ₂	KR	Freon12	Freon22	D ₂	Ne	CH ₄
1.00E-4	1.000	1.000	1.000	1.000	1.000	1.000	1.000	1.000	1.000	1.000	1.000
2.00E-4	1.301	1.301	1.301	1.301	1.301	1.301	1.301	1.301	1.301	1.301	1.301
5.00E-4	1.699	1.699	1.699	1.699	1.699	1.477	1.699	1.699	1.699	1.699	1.699
1.00E-3	2.000	1.845	1.903	2.000	2.041	1.602	2.176	2.176	2.114	1.845	2.230
2.00E-3	2.301	2.146	2.204	2.301	2.362	2.000	2.491	2.491	2.380	2.176	2.519
5.00E-3	2.699	2.519	2.602	2.699	2.643	2.362	2.881	2.845	2.778	2.544	2.886
1.00E-2	3.000	2.820	2.908	2.987	3.041	2.681	3.167	3.130	3.083	2.851	3.185
2.00E-2	3.301	3.117	3.207	3.297	3.346	2.978	3.476	3.435	3.386	3.149	3.483
5.00E-2	3.699	3.511	3.607	3.692	3.740	3.371	3.860	3.839	3.778	3.542	3.888
1.00E-1	4.000	3.808	3.914	3.988	4.029	3.670	4.155	4.134	4.083	3.845	4.201
2.00E-1	4.301	4.100	4.217	4.288	4.322	3.960	4.439	4.418	4.398	4.149	4.498
5.00E-1	4.699	4.494	4.638	4.687	4.689	4.336	4.786	4.774	4.837	4.555	4.893
1.00E+0	5.000	4.778	4.973	4.987	4.978	4.602	5.021	5.017	5.190	4.872	5.204
2.00E+0	5.301	5.057	5.346	5.288	5.233	4.845	5.210	5.220	5.616	5.201	5.522
5.00E+0	5.699	5.389	6.130	5.697	5.524	5.107	5.389	5.418	7.391	5.719	5.877
1.00E+1	6.000	5.602		6.013	5.696	5.250	5.471	5.530		6.332	6.446
2.00E+1	6.301	5.763		6.348	5.819	5.360	5.521	5.571		7.766	7.550
5.00E+1	6.699	5.895		6.890	5.915	5.410	5.579	5.617			7.925
1.00E+2	7.000	5.946		7.320	5.966	5.438	5.670	5.691			
2.00E+2	7.301	5.991		7.470	6.090	5.521	5.777	5.808			
3.00E+2	7.477	6.053		7.580	6.228	5.555	5.838	5.876			
4.00E+2	7.602	6.130		7.686	6.350	5.595	5.883	5.925			
5.00E+2	7.699	6.207		7.781	6.458	5.624	5.918	5.964			
6.00E+2	7.778	6.274		7.863	6.561	5.647	5.947	5.998			
7.00E+2	7.845	6.338		7.934	6.664	5.667	5.974	6.029			
7.60E+2	7.881	6.375		7.974	6.732	5.677	5.989	6.045			
8.00E+2	7.903	6.400		7.999	6.774	5.685	5.998	6.057			
9.00E+2	7.954	6.455			6.900	5.698	6.021	6.079			
1.00E+3	8.000	6.512			7.045	5.706	6.045	6.104			

Values listed under each gas type are in volts (V).

Example

The gas in use is O₂. Voltage output is 4.288 volts.
True pressure of O₂ is 2.00E-01 Torr

8.3.3.2 CG1 0 - 7 V or CG2 0 - 7 V Analog Output Correction Factors - Convection Gauge

When using the Log-Linear convection gauge analog output mode (Log-Linear 0 - 7 V, 1 V/decade) for gases other than air/N₂, use the following look-up table and information to convert the analog output to pressure. The look-up table has been derived from the equation provided in section 7.8

True Pressure (Torr)	N ₂	Ar	He	O ₂	CO ₂	KR	Freon12	Freon22	D ₂	Ne	CH ₄
1.00E-4	0.000	0.000	0.000	0.000	0.000	0.000	0.000	0.000	0.000	0.000	0.000
2.00E-4	0.301	0.301	0.301	0.301	0.301	0.301	0.301	0.301	0.301	0.301	0.301
5.00E-4	0.699	0.699	0.699	0.699	0.699	0.477	0.699	0.699	0.699	0.699	0.699
1.00E-3	1.000	0.845	0.903	1.000	1.041	0.602	1.176	1.176	1.114	0.845	1.230
2.00E-3	1.301	1.146	1.204	1.301	1.362	1.000	1.491	1.491	1.380	1.176	1.519
5.00E-3	1.699	1.519	1.602	1.699	1.643	1.362	1.881	1.845	1.778	1.544	1.886
1.00E-2	2.000	1.820	1.908	1.987	2.041	1.681	2.167	2.130	2.083	1.851	2.185
2.00E-2	2.301	2.117	2.207	2.297	2.346	1.978	2.476	2.435	2.386	2.149	2.483
5.00E-2	2.699	2.511	2.607	2.692	2.740	2.371	2.860	2.839	2.778	2.542	2.888
1.00E-1	3.000	2.808	2.914	2.988	3.029	2.670	3.155	3.134	3.083	2.845	3.201
2.00E-1	3.301	3.100	3.217	3.288	3.322	2.960	3.439	3.418	3.398	3.149	3.498
5.00E-1	3.699	3.494	3.638	3.687	3.689	3.336	3.786	3.774	3.837	3.555	3.893
1.00E+0	4.000	3.778	3.973	3.987	3.978	3.602	4.021	4.017	4.190	3.872	4.204
2.00E+0	4.301	4.057	4.346	4.288	4.233	3.845	4.210	4.220	4.616	4.201	4.522
5.00E+0	4.699	4.389	6.130	4.697	4.524	4.107	4.389	4.418	6.391	4.719	4.877
1.00E+1	5.000	4.602		5.013	4.696	4.250	4.471	4.530		5.332	5.446
2.00E+1	5.301	4.763		5.348	4.819	4.360	4.521	4.571		6.766	6.550
5.00E+1	5.699	4.895		5.890	4.915	4.410	4.579	4.617			6.925
1.00E+2	6.000	4.946		6.320	4.966	4.438	4.670	4.691			
2.00E+2	6.301	4.991		6.470	5.090	4.521	4.777	4.808			
3.00E+2	6.477	5.053		6.580	5.228	4.555	4.838	4.876			
4.00E+2	6.602	5.130		6.686	5.350	4.595	4.883	4.925			
5.00E+2	6.699	5.207		6.781	5.458	4.624	4.918	4.964			
6.00E+2	6.778	5.274		6.863	5.561	4.647	4.947	4.998			
7.00E+2	6.845	5.338		6.934	5.664	4.667	4.974	5.029			
7.60E+2	6.881	5.375		6.974	5.732	4.677	4.989	5.045			
8.00E+2	6.903	5.400		6.999	5.774	4.685	4.998	5.057			
9.00E+2	6.954	5.455			5.900	4.698	5.021	5.079			
1.00E+3	7.000	5.512			6.045	4.706	5.045	5.104			

Values listed under each gas type are in volts (V (dc)).

Example

The gas in use is O₂. Voltage output is 3.288 volts.
True pressure of O₂ is 2.00E-01 Torr

8.3.3.3 CG1 NON-LIN or CG2 NON-LIN Analog Output Correction Factors - Convection Gauge

When using the Non-Linear convection gauge analog output mode for gases other than air/N₂, use the following look-up table and information to convert the analog output to pressure. The look-up table has been derived from the equation provided in section 7.9

True Pressure (Torr)	N ₂	Ar	He	O ₂	CO ₂	KR	Freon12	Freon22	D ₂	Ne	CH ₄
0	0.3751	0.375	0.375	0.375	0.375	0.375	0.375	0.375	0.375	0.375	0.375
1.00E-4	0.3759	0.3757	0.3755	0.376	0.376	0.3755	0.376	0.376	0.376	0.3757	0.3766
2.00E-4	0.3768	0.376	0.3765	0.377	0.377	0.3768	0.378	0.378	0.377	0.3763	0.378
5.00E-4	0.3795	0.378	0.379	0.38	0.381	0.3772	0.382	0.381	0.381	0.3782	0.3825
1.00E-3	0.384	0.381	0.382	0.384	0.385	0.379	0.388	0.388	0.386	0.381	0.3896
2.00E-3	0.3927	0.387	0.389	0.392	0.395	0.384	0.401	0.4	0.396	0.388	0.403
5.00E-3	0.4174	0.403	0.409	0.417	0.412	0.395	0.437	0.432	0.425	0.405	0.438
1.00E-2	0.4555	0.429	0.441	0.453	0.462	0.415	0.488	0.48	0.47	0.433	0.492
2.00E-2	0.5226	0.477	0.497	0.521	0.536	0.451	0.581	0.566	0.549	0.484	0.584
5.00E-2	0.6819	0.595	0.637	0.679	0.705	0.544	0.778	0.764	0.727	0.608	0.796
1.00E-1	0.878	0.745	0.814	0.868	0.9	0.668	1.009	0.99	0.944	0.768	1.053
2.00E-1	1.1552	0.962	1.068	1.141	1.179	0.847	1.315	1.291	1.265	1.002	1.392
5.00E-1	1.6833	1.386	1.589	1.664	1.668	1.194	1.826	1.805	1.914	1.469	2.014
1.00E+0	2.2168	1.818	2.164	2.195	2.172	1.536	2.257	2.247	2.603	1.976	2.632
2.00E+0	2.8418	2.333	2.939	2.814	2.695	1.921	2.647	2.666	3.508	2.631	3.313
5.00E+0	3.6753	3.028	4.387	3.672	3.316	2.429	3.029	3.09	5.059	3.715	
1.00E+1	4.2056	3.48	5.774	4.225	3.67	2.734	3.204	3.33	6.361	4.605	4.699
2.00E+1	4.5766	3.801	7.314	4.62	3.903	2.966	3.308	3.414		5.406	5.172
5.00E+1	4.8464	4.037		4.916	4.071	3.075	3.43	3.509		6.159	5.583
1.00E+2	4.9449	4.122		5.026	4.154	3.134	3.618	3.66		6.483	5.72
2.00E+2	5.019	4.192		5.106	4.336	3.269	3.827	3.883		6.661	5.86
3.00E+2	5.1111	4.283		5.2	4.502	3.384	3.938	4.005		6.726	
4.00E+2	5.2236	4.386		5.315	4.621	3.466	4.016	4.088		6.767	6.103
5.00E+2	5.3294	4.477		5.422	4.708	3.526	4.076	4.151		6.803	
6.00E+2	5.4194	4.55		5.515	4.775	3.573	4.124	4.203		6.843	6.342
7.00E+2	5.4949	4.611		5.592	4.83	3.613	4.166	4.247		6.89	
7.60E+2	5.534	4.643		5.633	4.86	3.632	4.19	4.271		6.92	
8.00E+2	5.5581	4.663		5.658	4.877	3.645	4.203	4.286		6.942	6.519
9.00E+2	5.6141	4.706		5.713	4.919	3.674	4.237	4.321		7	
1.00E+3	5.6593	4.745		5.762	4.955	3.69	4.27	4.354		7.056	6.642

Values listed under each gas type are in volts (V (dc)).

9 Communication Protocol (Serial Interface)

9.1 Device Specific Serial Communication Info

The VGC083C provides RS232 and RS485 serial communications capability. The following information and the command protocol summaries listed in the following sub-sections of this chapter can be used to establish serial communications with the device. Four distinct protocols (COMM type) are defined: INFICON RS232 and RS485 protocol and RS232 and RS485 protocols compatible with GP series 307 and 358 controllers. The user has access from the front panel main menu to change settings for COM Type, Baud Rate, Data Bits, Parity, Stop Bits and device Address (when using RS485).

Baud Rate is selectable at 300, 600, 1200, 2400, 4800, 9600, 19200 or 38400 baud.

Data bits may be set to either 7 or 8.

Parity selection may be set to None, Even or Odd.

Either 1 or 2 Stop Bits may be selected.

The device address when using RS485 can be within the range 00 to FF hexadecimal (Default = 01).

There is a finite period of time between the time a command is sent from a terminal (PC COM Port, for example) and the point in time in which the VGC083C starts to send a response to that command. This delay is dependent upon the command sent and the baud rate.

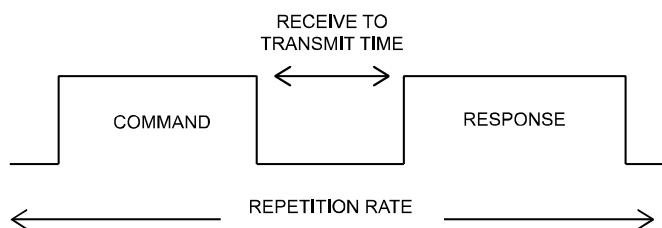

The maximum command repetition rate will depend on the length of the command sent and the response received, as well as the baud rate. The maximum repetition rate for the baud rate you are using can be found in the following table:

Selected Baud Rate	Repetition Rate	Receive to Transmit Time
38400	38 ms	26 μ s
19200	46 ms	52 μ s
9600	61 ms	1.0 ms
4800	93 ms	2.0 ms
2400	156 ms	4.1 ms
1200	280 ms	8.3 ms
600	530 ms	16 ms
300	1030 ms	33 ms

9.2 INFICON RS232 / RS485 Command Protocol Summary

The following notes are intended to be understood by the user when using INFICON's RS232 and RS485 command protocol with the VGC083C.

1. Default settings are 19,200 baud rate, 8 data bits, No Parity, 1 stop bit.
2. The baud rate can be set to different values using the front panel soft-keys.
3. All Responses are 13 characters long when COMM TYPE menu selected is RS485 or RS232.
4. 'xx' is the address of the device (00 thru FF). For RS232, 'xx' is replaced with two space characters.

5. <CR> is a carriage return, a non-printable character. Do not enter <CR> from your keyboard. A carriage return, non-printable character may be entered as the Unicode C0 controls specified value: 0D hexadecimal (13 decimal). From your keyboard, a key entry sequence of CNTL-M may be used to obtain the required character for a carriage return when using certain terminal emulator programs.
6. '_' represents a 'space' character. Press the space bar on your keyboard. Do not enter a '_' (underscore) character.
7. All commands sent to the controller start with a '#' character, and all normal responses from the controller start with a '*' character. Error responses start with a "?".
8. A valid address must be used [Factory default = 01] when using the RS485 protocol. The VGC083C will not respond to a command with an invalid address while using RS485.
9. The command syntax examples used in the protocol summary table for ASCII are shown in scientific notation. However, floating point notation is acceptable as long as a leading digit is entered as '0.' or '1.', etc. There must be a digit to the left of the decimal point. For example, when constructing the syntax for the command to set the CGn zero value (e.g., #xxTZn_x.xxE-pp<CR> when using scientific notation), use either #xxTZn_0.00<CR>, or #xxTZn_0<CR>. A simple '0' is valid for the pressure entry.

9.3 INFICON RS232 and RS485 Command Protocol Summary

The RS232 mode is the same as RS485, except ADDRESS is ignored in RS232 mode and must be eliminated from the command string or replaced with space characters. Responses will not return ADDRESS; the ADDRESS is replaced with space characters. Response is 13 characters including carriage return. All pressure measurement responses are in absolute pressure units as selected by the user. Please see qualifying notes at bottom of table.

Table "INFICON RS232 and RS485 Command Protocol Summary"

COMMAND	BRIEF DESCRIPTION	COMMAND SYNTAX	RESPONSE - EXAMPLES
READ ION GAUGE PRESSURE	Read the current displayed pressure of the ion gauge in the same units of measure on display	#xxRDIG<CR> e.g.: #01RDIG<CR> where, xx = the two digit address of the device (node)	*xx_y.yyEzpp<CR> where, y.yy = mantissa, z = sign of the exponent +/- and pp = the exponent e.g.: *01_1.53E-06<CR> When IG is off: *01_1.10E+03
READ CGn PRESSURE	Read the current pressure for CGn in the same units of measure on display	#xxRDCGn<CR> e.g.: #01RDCG1<CR> where, n=1 or 2 (CG1 or CG2)	*xx_y.yyEzpp <CR> e.g.: *01_7.60E+02<CR> When CG is over ranged: *01_1.10E+03
READ AI Pressure	Read the current pressure for AI in the same units of measure on display	#xxRDAI<CR> e.g.: #01RDAI<CR>	*xx_y.yyEzpp <CR> e.g.: *01_7.60E+02<CR> When AI is over ranged or not powered: *01_1.10E+03

(continued)

Table "INFICON RS232 and RS485 Command Protocol Summary" (continued)

COMMAND	BRIEF DESCRIPTION	COMMAND SYNTAX	RESPONSE - EXAMPLES
READ all Process Control (PC, or Relay) states	Read the current state of all process control setpoint relays	#xxRL<CR> e.g.: #01RL<CR>	*xx_003F_RL_<CR> In the example response above, the 'F' represents the first 4 relays; relays 5 and 6 are the second digit (the '3') of the response. This example shows that all relays are ON, i.e., energized. The '3F' would represent the binary string of 0011 1111, where 0011 is the 3 and 1111 is the F in '3F' A response of 0003 means that only RL1 and RL2 are ON, i.e., energized
READ one PC state	Read the current state of one process control setpoint	#xxRLn<CR> where n = 1,2,3,4,5 or 6 e.g.: #01RL1<CR>	*xx_0_RL_OFF<CR> *xx_1_RL_ON_<CR>
READ IG on/off STATUS	Find out if Ion Gauge is turned to ON and gauge is reading pressure	#xxIGS<CR> e.g.: #01IGS<CR>	*xx_0_IG_OFF<CR> *xx_1_IG_ON_<CR>
TURN IG ON	Turn the Ion Gauge ON	#xxIG1<CR> e.g.: #01IG1<CR> #xxIGy<CR> where, Y=1= Turn ON; y=0= Turn OFF	*xx_PROGM_OK<CR> When IG error exists: ?01_INVALID_<CR>
TURN IG OFF	Turn the Ion Gauge OFF	#xxIG0<CR> e.g.: #01IG0<CR> #xxIGy<CR> where, Y=1= Turn ON; y=0= Turn OFF	*xx_PROGM_OK<CR> Even though the IG will already be OFF, when an IG Error occurs, sending the IG OFF command will clear errors
SET CGn ZERO	Set the zero or vacuum calibration point for CGn	#xxTZCGn <CR> e.g.: #01TZCG1_0<CR> e.g.: #01TZCG2_1.23E-02 <CR> where, n=1 or 2 (for, CG1 or CG2) y.yy = mantissa, z = sign of the exponent +/- and pp = the exponent	*xx_PROGM_OK<CR> When P > 100 mTorr: ?01_INVALID_<CR> When CG is not connected: ?01_INVALID_<CR> When requested gauge number <1 or >2: ?01_SYNTAX_ER <CR>

(continued)

Table "INFICON RS232 and RS485 Command Protocol Summary" (concluded)

COMMAND	BRIEF DESCRIPTION	COMMAND SYNTAX	RESPONSE - EXAMPLES
SET CGn SPAN	Set the span or atmosphere calibration point for CGn	#xxTSCGn_y.yyEzpp<CR> e.g.: #01TSCG1_ 7.60E+02<CR> where, n=1 or 2 (for, CG1 or CG2) y.yy = mantissa, z = sign of the exponent +/- and pp = the exponent	*xx_PROGM_OK<CR> When P < 400 Torr: ?01_INVALID_<CR> When requested P < 400Torr: ?01_INVALID_<CR> When requested P > 1000mT: ?01_INVALID_<CR> When CG is not connected: ?01_INVALID_<CR> When requested gauge number <1 or >2: ?01_SYNTAX_ER <CR>

(continued)

NOTES:

1. <CR> is a carriage return (0x0D). This is the terminator character.
2. The '_' used in certain defined commands represent a space character. Space characters may be omitted from commands.
3. Hardware handshake controls do not exist on VGC083C (e.g., RTS, CTS, DTR).

9.4 RS232 GP 307 and 358 Protocol

RS232 protocol compatible with the GP Series 307 and 358 VGC is as defined in the following table. Please see qualifying notes at bottom of table.

Table "RS232 GP 307 and 358 Protocol"

COMMAND	BRIEF DESCRIPTION	COMMAND SYNTAX	RESPONSE - EXAMPLES
READ IG _n or, READ IG	Read the current IG pressure in units of Torr only, 1 = fil1, 2 = fil2 If you have selected filament 1 to operate with the IG ON (see 'IG ON' below), then enter IG1 in the READ IG _n command; use IG2 if filament 2 is turned ON	DS_IG _n <CR> <LF> e.g.: DS_IG1<CR><LF> or DS_IG<CR> <LF> e.g.: DS_IG1<CR><LF>	y.yyEzpp<CR><LF> e.g.: 1.53E-06<CR><LF> where, y.yy = mantissa, z = sign of the exponent +/- and pp = the exponent When IG is off: 9.90E+09
READ CG _n	Read the current CG pressure in units of Torr only	DS_CG _n <CR> <LF> e.g.: DS_CG1<CR><LF> where, n = 1 for device CG1 and n = 2 for CG2	y.yyEzpp<CR><LF> e.g.: 1.53E+02<CR><LF> When CG is not connected: 9.90E+09 When CG is over ranged: 9.90E+09
READ PCs in long form	Read the current Process Control setpoint relay status	PCS<CR> <LF> e.g.: PCS<CR><LF>	x,x,x,x,x,x,x,x<CR><LF> e.g.: 1,1,0,0,0,0<CR><LF> Relays 1 and 2 are energized; order is Relay No.1,2,3,4,5,6 from left to right.
READ PCs in binary form	Read the current Process Control setpoint relay status {continued on next page} {continued from previous page}	PCS_B<CR> <LF> e.g.: PCS_B<CR><LF>	x<CR><LF> e.g.: C<CR><LF> The Latin alphabet character "C" corresponds to binary 01000011 or, 43hex, which represents relay 1 and relay 2 are energized (ON). Note that the positions of the relay order in the returned code character are reversed from the long form as described for the READ PCs in long form command above. In binary form, the order is Relay No.6, 5, 4, 3, 2, and 1 as read from left to right.
READ individual PC	Read the current individual Process Control setpoint relay status	PCS_n<CR> <LF> e.g.: PCS_1<CR><LF>	s<CR><LF> where, s=state of relay: 1 = ON; 0 = OFF e.g.: 1<CR><LF> (PC Relay 1 is energized, or 0 when not)
IG ON	Turn specified IG filament ON Note that the functions of IG ON/OFF and Filament Selection are combined in the single IG ON/OFF command. When turning the IG to ON, the specific filament chosen is selected when sending the IG ON/OFF commands.	IG _n _ON<CR> <LF> e.g.: IG1_ON<CR><LF> where, n = 1 = fil1, 2 = fil2	OK<CR><LF> e.g.: OK<CR><LF> When IG is already ON: INVALID

(continued)

Table "RS232 GP 307 and 358 Protocol" (concluded)

COMMAND	BRIEF DESCRIPTION	COMMAND SYNTAX	RESPONSE - EXAMPLES
IG OFF	Turn specified IG filament OFF	IG _n _OFF<CR> <LF> e.g.: IG1 OFF<CR><LF> where, n = 1 = fil1, 2 = fil2	OK<CR><LF> e.g.: OK<CR><LF> When IG is already OFF: INVALID

NOTES:

1. <CR> is a carriage return (0x0D).
2. <LF> is a line feed (0x0A); this is the terminator character.
3. The '_' used in certain defined commands represent a space character. Space characters may be omitted from commands.
4. GP 307 and 358 protocol response strings are variable length.
5. Hardware handshake controls do not exist on VGC083C (e.g., RTS, CTS, DTR).

9.5 RS485 GP 307 and 358 Protocol

RS485 protocol compatible with the GP Series 307 and 358 VGC is as defined in the following table. Please see the qualifying notes listed at bottom of table.

Table "RS485 GP 307 and 358 Protocol"

COMMAND	BRIEF DESCRIPTION	COMMAND SYNTAX	RESPONSE - EXAMPLES
READ IG _n or, READ IG	Read the current IG pressure in units of Torr only	#xxDS_IG _n <CR> e.g.: #01DS IG1<CR> where, n = 1 = fil1, 2 = fil2 or DS_IG<CR> <LF> e.g.: DS_IG1<CR><LF>	y.yyEzpp<CR> e.g.: 1.53E-06<CR> where, y.yy = mantissa, z = sign of the exponent +/- and pp = the exponent When IG is off: 9.90E+09
READ CG _n	Read the current CG pressure in units of Torr only	#xxDS_CG _n <CR> e.g.: #01DS CG1<CR> where, n = 1 or 2 (CG1 or CG2)	y.yyEzpp<CR> where, y.yy = mantissa, z = sign of the exponent +/- and pp = the exponent e.g.: 1.53E+02<CR> When CG is not connected: 9.90E+09 When CG is over ranged: 9.90E+09
READ PCs long form	Read the current PC setpoint status	#xxPCS<CR> e.g.: #01PCS<CR>	x,x,x,x,x,x<CR> e.g.: 1,1,0,0,0,0<CR> (Relays 1 and 2 are energized; Relays 3 - 6 are not energized)
READ PCs binary form	Read the current PC setpoint status	#xxPCS_B<CR> e.g.: #01PCS B<CR>	x<CR> e.g.: C<CR> (where 'C' is the Unicode character C, expressed as 01000011 in binary notation or 43 hexadecimal)
READ individual PC	Read the current individual PC setpoint status	#xxPCS_x<CR> e.g.: #01PCS_1<CR><LF>	x<CR> e.g.: 1<CR> (where '1' indicates PC 1 is energized; 0 when not)

(continued)

Table "RS485 GP 307 and 358 Protocol" (concluded)

COMMAND	BRIEF DESCRIPTION	COMMAND SYNTAX	RESPONSE - EXAMPLES
IG ON	Turn specified IG filament ON	#xxIGn_ON<CR> e.g.: #01IG1 ON<CR> where, n = 1 = fil1, 2 = fil2	OK<CR> e.g.: OK<CR> When IG already ON: INVALID
IG OFF	Turn specified IG filament OFF	#xxIGn_OFF<CR> e.g.: #01IG1 OFF<CR> n = 1 = fil1, 2 = fil2	OK<CR> e.g.: OK<CR> When IG already OFF: INVALID

NOTES:

1. <CR> is a carriage return (0x0D). This is the terminator character.
2. The '_' used in certain defined commands represent a space character. Space characters may be omitted from commands.
3. GP 307 and 358 protocol response strings are variable length.

10 Service

10.1 Calibration

Every INFICON module is calibrated prior to shipment using nitrogen. Care should be exercised when using gases other than nitrogen (N₂) / air (see previous sections regarding the use of gases other than N₂/air).

10.2 Maintenance

Periodic performance checks may be done by comparing the vacuum gauges to a known reference standard. When using the transducer in gases containing contaminants periodic cleaning of the cold cathode sensor is recommended. Refer to the Operating Manual of MAG050 / MAG060 for such cleaning instructions.

10.3 Troubleshooting - Operation

Indication	Possible Cause	Possible Solution
Display on VGC083C controller indicates OFF	No power	Check cable connections and verify that power is being supplied
Displayed pressure appears very different from expected pressure	Sensor not in the proper location to measure system pressure	Ensure the sensor is located in appropriate location
	The process gas is different from the gas (Nitrogen) used to calibrate the MAG050 / MAG060	Apply gas correction factor if applicable
	Sensor has been dropped causing mechanical damage	Replace the cold cathode sensor
Displayed pressure is significantly lower than expected pressure	Gauge is contaminated	Clean or replace sensor
	Leak in the vacuum system	Re-check for leak in the system. Check that all metal seals are used when operating below 1.00×10^{-7} Torr
	Incorrect Sensitivity or CAL FACTORS	Ensure correct values programmed
Gauge cannot be activated (unable to turn anode voltage on)	The gauge sensor is contaminated	Clean or replace sensor
	Incorrect Sensitivity and CAL FACTORS	Ensure correct values programmed
Gauge will not start at low pressure	Pressure exceeds value programmed for OVER PRESSURE in the SETUP IG menu	Decrease pressure below required value
	Chamber pressure higher than 5.00×10^{-3} Torr	Decrease chamber pressure below value programmed for OVER PRESSURE in the ION GAUGE menu
Research Screen shows anode Voltage is present but total current stays at zero	Pressure is too low to initiate discharge	Repeat step to activate sensor
		Increase HV TIMEOUT to allow more time for sensor activation
		Increase pressure
Research Screen shows anode Voltage is present but total current stays at zero	Defective electronics	Repair or replace electronics

10.4 Troubleshooting - Error Messages

Indication	Possible Cause	Possible Solution
OVERPRESSURE	Pressure exceeds value programmed for OVER PRESSURE in the SETUP IG menu Chamber pressure higher than the OVER PRESSURE value	Decrease chamber pressure below required value Decrease chamber pressure below value programmed for OVER PRESSURE in the SETUP IG menu
HV FAILURE	Chamber pressure higher than the OVER PRESSURE value Defective Electronics	Decrease pressure below the OVER PRESSURE value Repair or replace electronics
CURRENT FAIL	Sensor contamination Defective Electronics	Clean or replace sensor Repair or replace electronics
DISCHARGE FAIL	Electrical discharge has not been established to activate sensor Defective Electronics	Repeat step to activate sensor Increase HV TIMEOUT to allow more time for sensor activation Repair or replace electronics
COMM IO FAIL	Internal PCB not communicating	Contact INFICON

10.5 Clearing Error Messages

Once the cause of the IG error has been determined and resolved, the IG error must be cleared before the IG anode can be turned on again. To clear errors, simply press the IG ON/OFF key.

10.6 Research Screen

The OLED setup screen of the VGC083C can be configured to display important, critical operating parameters of the MAG050 / MAG060. These parameters can be displayed in the Research display mode as described below.

10.6.1 Research Screen (Diagnostic Display)

When you have a MAG050 / MAG060 connected to the VGC083C, the Research display screen will show electrometer current (discharge current) and the cold cathode IG anode voltage similar to the following:

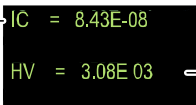
Discharge current value (A) →  ← Anode high voltage V (dc)

The indication of 'IC' in the top line of this display is a real time measurement of the cold cathode discharge current. This current is proportional to the density of gas inside the transducer (sensor). The VGC083C front panel indication of pressure is based on this discharge current level. As the gas density increases the discharge current also increases. The pressure reading for the cold cathode ionization gauge is determined by the output of an electrometer circuit in the MAG050 / MAG060, a nominal curve-fit algorithm and a look-up table that resides in the VGC083C controller operating system.

The indication of 'HV' in the bottom line of this display is a real time measurement of the cold cathode anode voltage. This voltage will change with increasing pressure. If the pressure reading that you see in the VGC083C LED IG display line is lower than expected, these two indications in the RESEARCH Screen may be viewed to, perhaps, discern the relative conditions of the measurement being made. If the cold cathode IG has become contaminated, excess electrical current leakage may occur causing the anode voltage to be lower than it should be for the pressure measurement to be realistic. The best practice is to document the discharge current and anode voltage at initial installation of the device then, thereafter at periodic intervals over time at a known operating pressure for your system. In

general, your system base pressure may be relatively stable (assuming no leaks have developed and that the vacuum pump is operating at normal pumping capacity). The base or ultimate pressure of your vacuum system may be a good pressure level to periodically check and record the readings displayed in the RESEARCH Screen.

10.7 Cleaning the VGC083C

For cleaning the outside of the unit a slightly moist cloth will usually do. Do not use any aggressive or scouring cleaning agents.

11 Repair

Return defective products to your nearest INFICON service center for repair. INFICON assumes no liability and the warranty is rendered null and void if repair work is carried out by the end-user or by third parties.

12 Accessories

Power supply		Ordering number
	Power supply to VGC083C (no power cord included ¹⁾)	399-711
	¹⁾ The conventional IEC60320 AC receptacle allows use with any user supplied AC mains power cord set available worldwide.	
Rack mount adapter		Ordering number
	Rack mount adapter for 19" 2U for one VGC083C	399-714
	Rack mount adapter for 19" 2U for two VGC083C	399-715
Cables 250 °C MAG050, MAG060		Ordering number
	Cable 3 m / 10 ft, 250 °C, MAG050, MAG060	399-830
	Cable 8 m / 25 ft, 250 °C, MAG050, MAG060	399-831
	Cable 15 m / 50 ft, 250 °C, MAG050, MAG060	399-832
Cables 80 °C MAG050, MAG060		Ordering number
	Cable 3 m / 10 ft, 80 °C, MAG050, MAG060	399-820
	Cable 8 m / 25 ft, 80 °C, MAG050, MAG060	399-821
	Cable 15 m / 50 ft, 80 °C, MAG050, MAG060	399-822
Cables 50 °C PEG050		Ordering number
	Cable 3 m / 10 ft, 50 °C, PEG050	399-580
	Cable 8 m / 25 ft, 50 °C, PEG050	399-581
	Cable 15 m / 50 ft, 50 °C, PEG050	399-582

13 Storage



Caution



Electronic components.

Inappropriate storage (static electricity, humidity etc.) may damage electronic components.

Store the product in an antistatic bag or container. Observe the relevant specifications under Technical Data (→ 8).

14 Disposal



WARNING



Detrimental to the environment.

Products or parts thereof (mechanical and electric components, operating fluids etc.) may be detrimental to the environment.

Please dispose of such materials in accordance with the relevant local regulations.

Separating the components

Electronic and non-electronic components

After disassembling the product, separate its components in accordance with the following criteria:

Such components must be separated according to their materials and recycled.

EU Declaration of Conformity



We, INFICON, hereby declare that the equipment mentioned below complies with the provisions of the following directives:

- 2014/30/EU, OJ L 96/79, 29.3.2014
(EMC Directive; Directive relating to electromagnetic compatibility)
- 2011/65/EU, OJ L 174/88, 1.7.2011
(RoHS Directive; Directive on the restriction of the use of certain hazardous substances in electrical and electronic equipment)

Product

Vacuum Gauge Controller
VGC083C

Part numbers

399-702

Standards

Harmonized and international/national standards and specifications:

- EN 61000-6-2:2005
(EMC: generic immunity standard for industrial environments)
- EN 61000-6-4:2007 + A1:2011
(EMC: generic emission standard for industrial environments)
- EN 61010-1:2010
(Safety requirements for electrical equipment for measurement, control and laboratory use)
- EN 61326-1:2013; Group 1, Class A
(EMC requirements for electrical equipment for measurement, control and laboratory use)

Manufacturer / Signatures

INFICON AG, Alte Landstraße 6, LI-9496 Balzers

9 July 2018

9 July 2018



Dr. Benhard Andreus
Director Product Evolution

Markus Truniger
Product Manager

Notes

Original: English



tinb42e1-a



LI-9496 Balzers
Liechtenstein
Tel +423 / 388 3111
Fax +423 / 388 3700
reachus@inficon.com

www.inficon.com