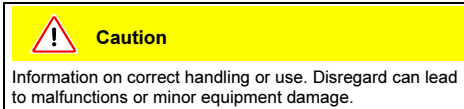
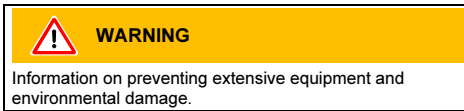
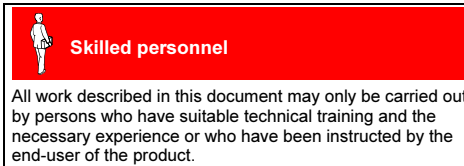

Symbols Used

Personnel Qualifications

General Safety Instructions

- Adhere to the applicable regulations and take the necessary precautions for all work you are going to do and consider the safety instructions in this document.
- Adhere to the applicable regulations and take the necessary precautions for all work you are going to do and consider the safety instructions in this document.
- Before beginning to work, find out whether any vacuum components are contaminated. Adhere to the relevant regulations and take the necessary precautions when handling contaminated parts.

Communicate the safety instructions to all other users.

Liability and Warranty

Inficon assumes no liability and the warranty becomes null and void if the end-user or third parties

- disregard the information in this document
- use the product in a non-conforming manner
- make any kind of interventions (modifications, alterations etc.) on the product
- use the product with accessories not listed in the corresponding product documentation.

The end-user assumes the responsibility in conjunction with the process media used.

Technical Data

Vacuum connection	ø5 mm / M14x1
Vacuum connection (accessories)	<ul style="list-style-type: none"> flange fitting DN 10 ISO-KF pipe connection OD ¼" pipe connection OD 6 mm
Nominal voltage	24 VDC ±10%
Nominal power	1 W
Duty cycle	100% (i.e. continuous duty possible)
Compressed air Connection	ø4 mm
Pressure range	4 ... 8 bar overpressure
Volume	0.24 cm ³
Protection class	IP 65 according to DIN 40 050
Conductance for air	0.4 l/s
Molecular flow	4 l/s
Laminar flow	4 l/s
Mounting orientation	any
Switching frequency max.	150 / min ¹⁾
Cycles to first maintenance	≈5,000,000 ²⁾
Tightness	1×10 ⁻⁹ mbar l/s
Pressure range	1×10 ⁻⁶ mbar ... 4 bar (absolute)
Pressure difference Δp	
In closing direction	3 bar
In opening direction	3 bar
Opens against Δp	3 bar (compressed air: overpressure 4 bar)
Closing time	35 ms
Opening time	35 ms
	(Δp = 0, compressed air: 4 bar overpressure)
Temperatures	
Ambiance	5 °C ³⁾ ... 80 °C
Bakeout	150 °C (actuator 80 °C)
Materials	
Housing	stainless steel 1.4301
Bellows	stainless steel 1.4301
Actuator	anodized aluminum
Seals	FPM
Weight	0.2 kg

- With pressure difference Δp = 0.
- Under clean operating conditions.
- 15 °C, if the ambience is free of condensable gases.

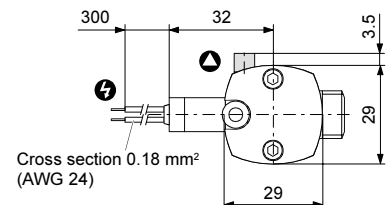
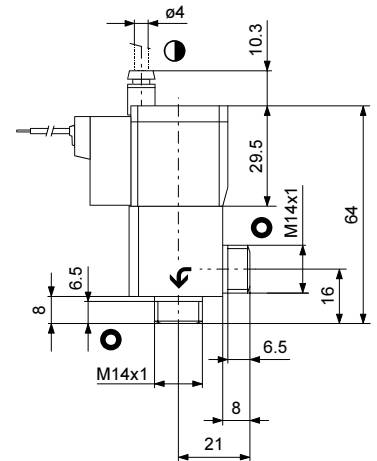
Dimensions [mm]

- Flow direction
- Compressed air inlet
- Compressed air outlet with silencer
- Electrical connection
- Protective lid

Angle Valve

electropneumatically operated, bellows sealed
VAP005-X

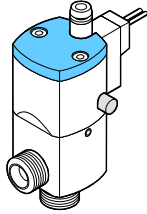

Instruction Sheet
Incl. Manufacturer's Declaration

sima09e1 (0104)

Product Identification

In all communications with Inficon, please specify the information on the product nameplate. For convenient reference copy that information into the space provided below.

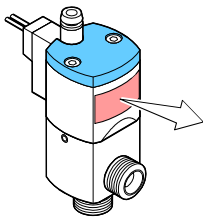

INFICON AG, LI-9496 Balzers
Typ: - - - - -
No: - - - - -
F-No: - - - - -

Validity

This document applies to products with part number 250-050. The part number (No.) can be taken from the product nameplate.

We reserve the right to make technical changes without prior notice.

All dimensions in mm.

Intended Use

The angle valve is universally used in vacuum systems.

Functional Principle

The VAP005-X is opened electropneumatically and closed by a pressure spring.

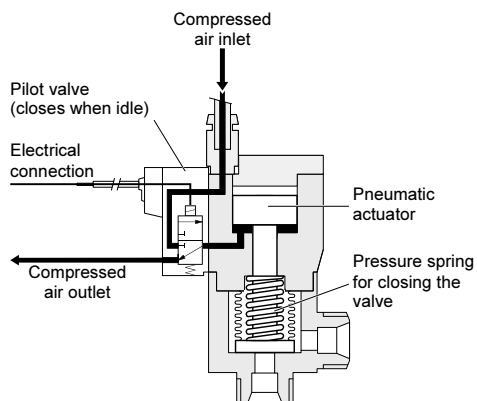

It closes automatically in the event of a power or compressed air failure.

Installation dimensions with accessories (see chapter "Installation" for part numbers of accessories)

Flange fitting

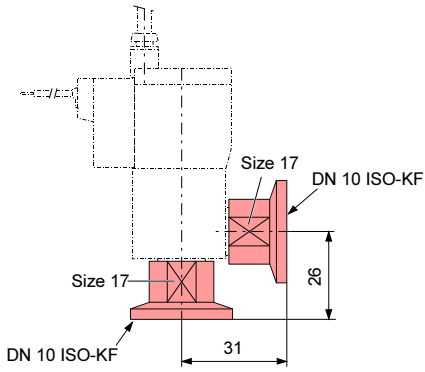

Pipe connection

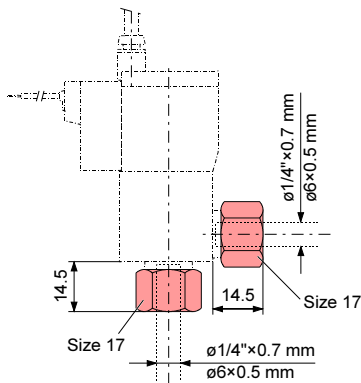

Flange fitting and pipe connection

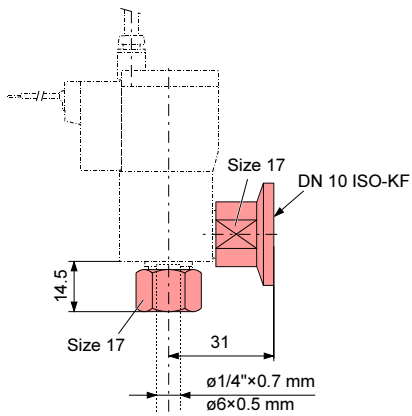

Installation

Vacuum Connection

Caution



Caution: vacuum component
Dirt and damages impair the function of the vacuum component.
When handling vacuum components, take appropriate measures to ensure cleanliness and prevent damages.

Caution



Caution: dirt sensitive area
Touching the product or parts thereof with one's bare hands increases the desorption rate.
Always wear clean, lint-free gloves and use clean tools when working in this area.

1 Remove the protective lids.

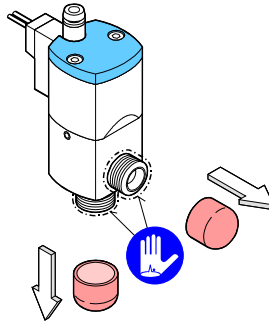

Keep the protective lids.

2 Establish the vacuum connection by means of the accessories.

Accessories (1 piece per part number)

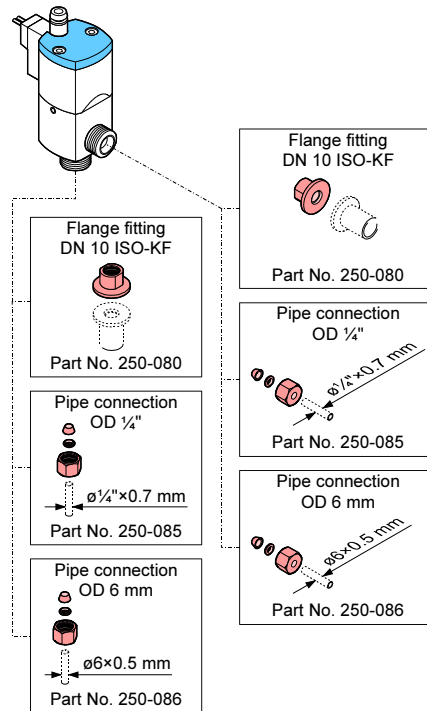

Installation of the accessories according to the manual supplied with the parts.

Compressed Air Connection

DANGER



Caution: compressed air
Unprofessionally handling compressed air can cause physical injury.
Adhere to the relevant regulations and take the necessary precautions when handling compressed air.

Caution



Specifications for the plastic tube:

- $\phi 4 \text{ mm}$
- bursting pressure $\geq 10 \text{ bar}$ (overpressure)
- material: PA soft or PU.

Caution



To ensure leak tightness

- cut the plastic tube square
- make sure the outside of the plastic tube is not damaged.

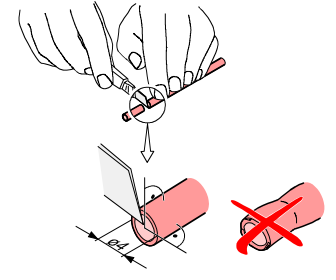

Insert the plastic tube into the connection until the mechanical stop is reached and verify correct mounting by applying a slight pull.

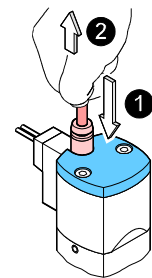

The compressed air must meet the following specifications:

- free of oil
- dry
- free of particles $> 10 \mu\text{m}$
- 4 ... 8 bar (overpressure)

Electrical Connection



Before connecting or disconnecting the product, turn off the control system.

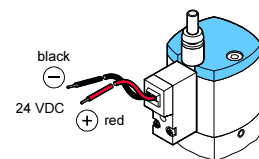

Be careful to correctly connect the poles.



(0104)

Original: German sima09d1 (0104)

Operation

The product is ready for operation as soon as it has been installed.

Valve position

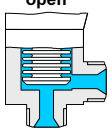
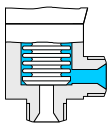
Nominal voltage	Compressed air	Valve
available	available	open 
available	not available	closed 
not available	available	
not available	not available	

 In the event of a power failure, the pilot valve can be manually actuated with the emergency button, if compressed air is available:

- Open the valve by pressing the emergency button
- Close the valve by releasing the emergency button.

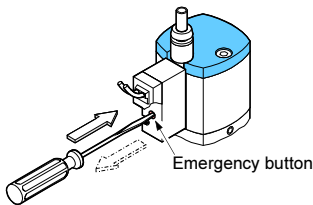

Pressure difference Δp in closing direction

Caution

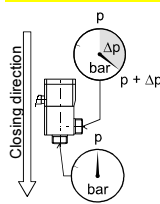
Caution: pressure difference
With $\Delta p > 3$ bar the valve may be damaged.
Avoid pressure differences $\Delta p > 3$ bar.

Pressure difference Δp in opening direction

Caution

Caution: pressure difference
With $\Delta p > 3$ bar the valve is opened.
Avoid pressure differences $\Delta p > 3$ bar.

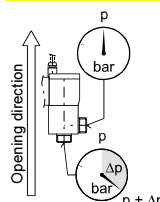
Opens against a pressure difference Δp

Caution

Caution: pressure difference
With $\Delta p > 3$ bar the valve may be damaged.
Avoid pressure differences $\Delta p > 3$ bar.

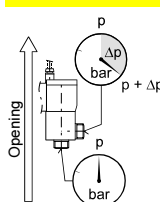
Deinstallation

DANGER

 Caution: contaminated parts
Contaminated parts can be detrimental to health and environment.
Before beginning to work, find out whether any parts are contaminated. Adhere to the relevant regulations and take the necessary precautions when handling contaminated parts.

DANGER

 Caution: compressed air
Physical injury can result if a pressurized compressed air line is disconnected.
Before doing any work, turn off the compressed air supply and relieve the compressed air lines.

Caution

 Caution: vacuum component
Dirt and damages impair the function of the vacuum component.
When handling vacuum components, take appropriate measures to ensure cleanliness and prevent damages.

Caution

 Caution: dirt sensitive area
Touching the product or parts thereof with one's bare hands increases the desorption rate.
Always wear clean, lint-free gloves and use clean tools when working in this area.

Preconditions

- Vacuum system is vented
- Compressed air supply has been interrupted
- Compressed air line is vented
- Control system is turned off.

Procedure

- 1 Disconnect the valve from the control system.

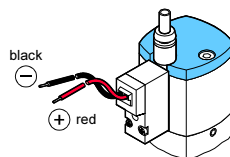

- 2 Press the ring towards the valve and pull the plastic tube.

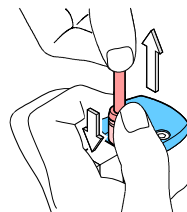

- 3 Remove valve from vacuum system and place the protective lids.

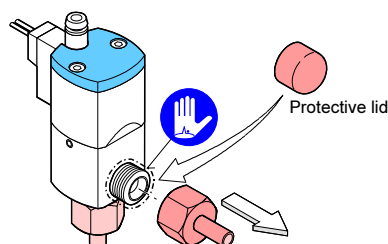

Maintenance/Repair

See Operating Manual sina09e1. It can be downloaded from our website.

Returning the Product

WARNING

 Caution: forwarding contaminated products
Contaminated products (e.g. radioactive, toxic, caustic or microbiological hazard) can be detrimental to health and environment.
Products returned to Inficon should preferably be free of harmful substances. Adhere to the forwarding regulations of all involved countries and forwarding companies and enclose a duly completed declaration of contamination (→ "Declaration of Contamination").

Products that are not clearly declared as "free of harmful substances" are decontaminated at the expense of the customer. Products not accompanied by a duly completed declaration of contamination are returned to the sender at his own expense.

Disposal

DANGER

 Caution: contaminated parts
Contaminated parts can be detrimental to health and environment.
Before beginning to work, find out whether any parts are contaminated. Adhere to the relevant regulations and take the necessary precautions when handling contaminated parts.

WARNING

 Caution: substances detrimental to the environment
Products or parts thereof (mechanical and electric components, operating fluids etc.) can be detrimental to the environment.
Dispose of such substances in accordance with the relevant local regulations.

Separating the components

After disassembling the product, separate its components according to the following criteria:

- Contaminated components
Contaminated components (radioactive, toxic, caustic, or biological hazard etc.) must be decontaminated in accordance with the relevant national regulations, separated according to their materials, and disposed of.
- Other components
Such components must be separated according to their materials and recycled.

Declaration of Contamination

The service, repair, and/or disposal of vacuum equipment and components will only be carried out if a correctly completed declaration has been submitted. Non-completion will result in delay. This declaration may only be completed (in block letters) and signed by authorized and qualified staff.

1 Description of product
 Type _____
 Article Number _____
 Serial Number _____

2 Reason for return

3 Operating fluid(s) used (Must be drained before shipping.)

4 Process related contamination of product:

toxic	no <input type="checkbox"/> 1)	yes <input type="checkbox"/>
caustic	no <input type="checkbox"/> 1)	yes <input type="checkbox"/>
biological hazard	no <input type="checkbox"/>	yes <input type="checkbox"/> 2)
explosive	no <input type="checkbox"/>	yes <input type="checkbox"/> 2)
radioactive	no <input type="checkbox"/>	yes <input type="checkbox"/> 2)
other harmful substances	no <input type="checkbox"/> 1)	yes <input type="checkbox"/>

2) Products thus contaminated will not be accepted without written evidence of decontamination!

The product is free of any substances which are damaging to health
 yes

1) or not containing any amount of hazardous residues that exceed the permissible exposure limits

5 Harmful substances, gases and/or by-products
 Please list all substances, gases, and by-products which the product may have come into contact with:

Trade/product name	Chemical name (or symbol)	Precautions associated with substance	Action if human contact

6 Legally binding declaration:
 I/we hereby declare that the information on this form is complete and accurate and that I/we will assume any further costs that may arise. The contaminated product will be dispatched in accordance with the applicable regulations.

Organization/company _____
 Address _____ Post code, place _____
 Phone _____ Fax _____
 Email _____
 Name _____

Date and legally binding signature _____ Company stamp _____

This form can be downloaded from our website.

Copies: Original for addressee - 1 copy for accompanying documents - 1 copy for file of sender

Manufacturer's Declaration

as defined by the Directive relating to machinery 98/37/EC, Appendix IIb

We, Inficon, hereby declare that putting the incomplete equipment mentioned below into operation is not permitted until evidence is given that the system into which that incomplete equipment shall be installed is in accordance with the provisions of the EC Directive relating to machinery.

Angle Valve

electropneumatically operated, bellows sealed
VAP005-X

Part number
 250-050

Standards

Harmonized and international/national standards and specifications:

- EN 292-1/-2 (Safety of machinery)
- EN 294 (Safety distances to prevent danger zones being reached by the upper limbs)
- EN 60204-1 (Electrical equipment of machines)

Signatures

Inficon AG, Balzers
 17 April 2001

Hans-Christoph Gehlhar
 Product management

17 April 2001

Dr. Georg Sele
 Technical Support Manager
 Quality Representative



LI-9496 Balzers
 Liechtenstein
 Tel +423 / 388 3111
 Fax +423 / 388 3700
 reach.liechtenstein@inficon.com
 www.inficon.com