

Rotary/linear motion feedthrough

DN 40 ISO-KF
FCH040-H

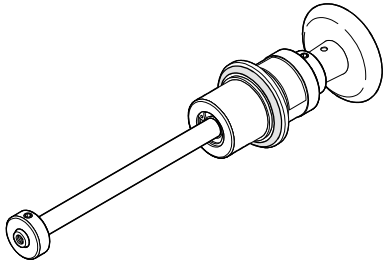

Operating Manual
incl. Manufacturer's Declaration

rina08e1 (0004)

Product Identification

In all communications with Inficon please specify the information on the product nameplate. For convenient reference copy that information into the space provided below.

INFICON, FL-9496 Balzers
Typ: FCH040-H
No: 214-324
F-No: _____

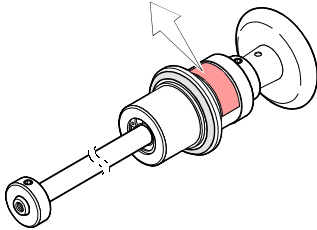

Validity

This document applies to products with part number 214-324.

We reserve the right to make technical changes without prior notice.

Intended Use

The rotary/linear motion feedthrough FCH040-H is used for transferring rotary and linear movements into vacuum systems.

Functional Principle

The motions performed at atmosphere are transferred directly to the vacuum system.

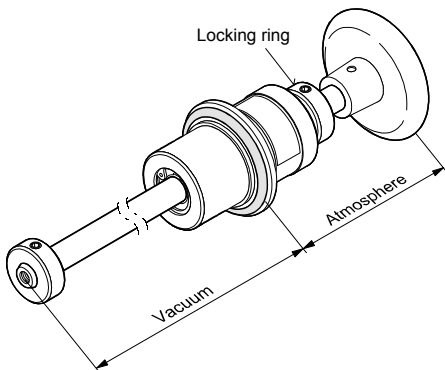

Safety

Symbols Used

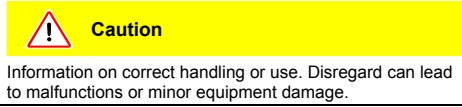
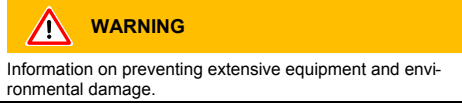

Personnel Qualifications

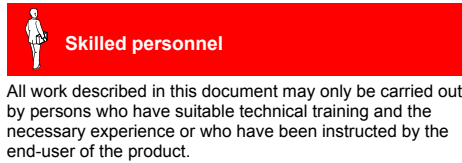

General Safety Instructions

- Adhere to the applicable regulations and take the necessary precautions for all work you are going to do and consider the safety instructions in this document.
- Before you begin to work, find out whether any vacuum components are contaminated. Adhere to the relevant regulations and take the necessary precautions when handling contaminated parts.

Communicate the safety instructions to all other users.

Liability and Warranty

Inficon assumes no liability and the warranty becomes null and void if the end-user or third parties

- disregard the information in this document
- use the product in a non-conforming manner
- make any kind of changes (modifications, alterations etc.) to the product
- use the product with accessories not listed in the corresponding product documentation.

The end-user assumes the responsibility in conjunction with the process media used.

Technical Data

Connection flange	DN 40 ISO-KF
Shaft connection	M6×10 mm or ø12 mm
Mounting orientation	any
Tightness static dynamic	1×10 ⁻⁹ mbar l/s 1×10 ⁻⁹ mbar l/s 1×10 ⁻⁴ mbar l/s
Pressure range	1×10 ⁻⁸ mbar 1 bar (absolute)
Maximum displacement	150 mm
Shaft load radial, at max. displacement torsion	30 N 20 Nm
Temperatures operation (static, dynamic) bakeout storage	50 °C 110 °C -15 °C ... +60 °C
Materials housing shaft	Al alloy, coated stainless steel, nonmagnetic
seal	FPM
Weight	0.3 kg

Dimensions

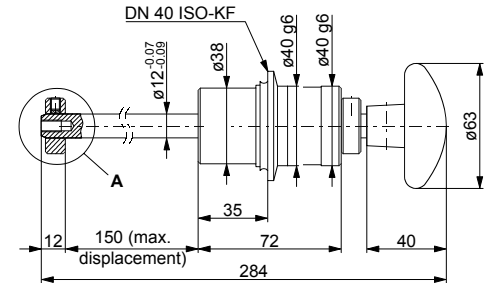

Detail A

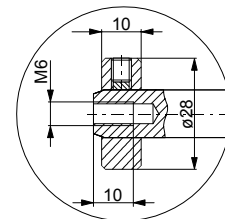

Installation

Caution



Caution: vacuum component
Dirt and damages impair the function of the vacuum component.
When handling vacuum components, take appropriate measures to ensure cleanliness and prevent damages.

Caution



Caution: dirt sensitive area
Touching the product or parts thereof with one's bare hands increases the desorption rate.
Always wear clean, lint-free gloves and use clean tools when working in this area.

- 1 Establish the vacuum connection.

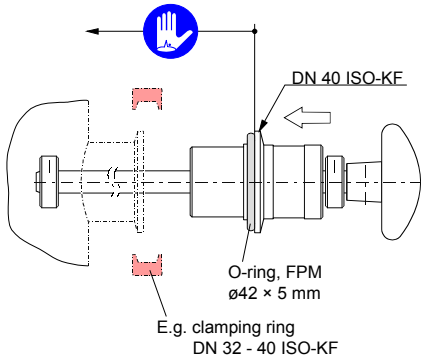

- 2 Install the process related component (e.g. orifice)

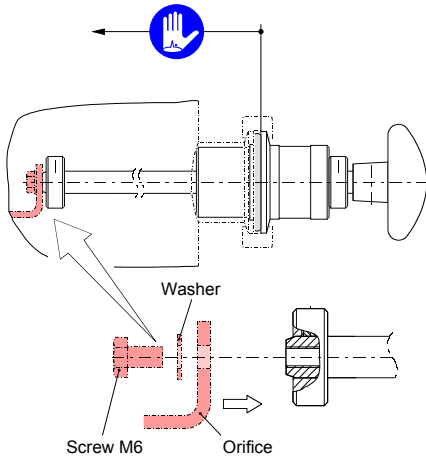

- 3 Limit the displacement (immersion depth)
(factory setting: 150 mm).

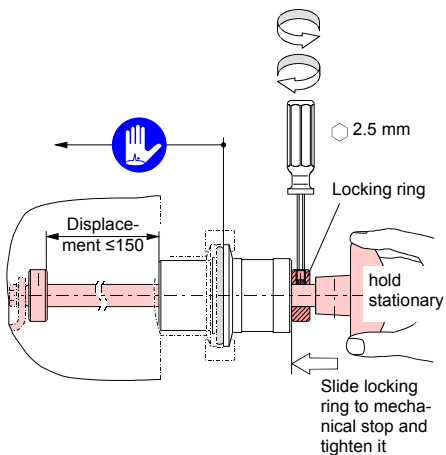

Operation

The rotary/linear motion feedthrough is ready for operation as soon as it has been installed.

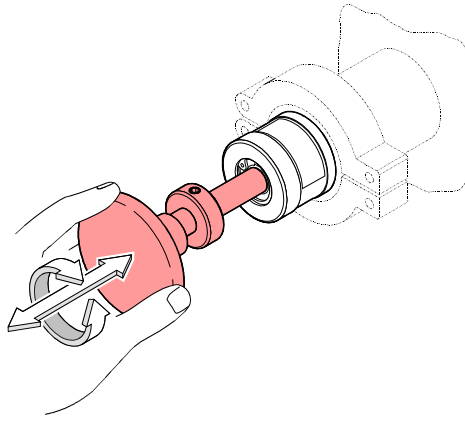

Deinstallation

DANGER



Caution: contaminated parts
Contaminated parts can be detrimental to health and environment.
Before beginning to work, find out whether any parts are contaminated. Adhere to the relevant regulations and take the necessary precautions when handling contaminated parts.

Caution



Caution: vacuum component
Dirt and damages impair the function of the vacuum component.
When handling vacuum components, take appropriate measures to ensure cleanliness and prevent damages.

Caution



Caution: dirt sensitive area
Touching the product or parts thereof with one's bare hands increases the desorption rate.
Always wear clean, lint-free gloves and use clean tools when working in this area.

- 1 Vent the vacuum system.

- 2 Detach the process related component.

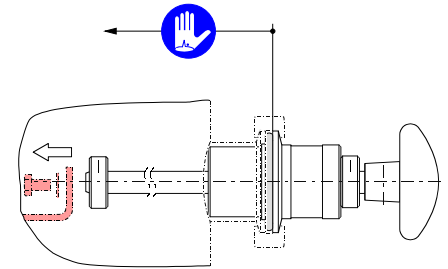

- 3 Detach the vacuum connection.

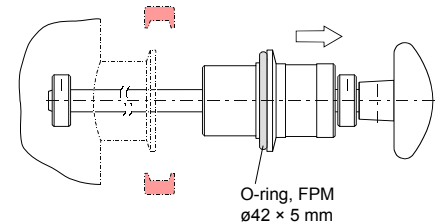

Maintenance

The product requires no maintenance.

Repair

We recommend returning the product to your nearest Inficon-Service Center for repair.

Inficon assumes no liability and the warranty becomes null and void if any repair work is carried out by the end-user or third parties.

Storage

 **Caution**



Caution: vacuum component
Inappropriate storage leads to an increase of the desorption rate and/or may result in mechanical damage of the product.
Cover the side of the product which is going to be exposed to the vacuum with grease free aluminum foil. Do not exceed the admissible storage temperature range (→ "Technical data").

Returning the Product

 **WARNING**





Caution: forwarding contaminated products
Contaminated parts (e.g. radioactive, toxic, caustic or microbiological) can be detrimental to health and environment.
Products returned to Inficon should preferably be free of harmful substances. Adhere to the forwarding regulations of all involved countries and forwarding companies and enclose a duly completed declaration of contamination.

Products that are not clearly declared as "free of harmful substances" are decontaminated at the expense of the customer.

Products not accompanied by a duly completed declaration of contamination are returned to the sender at his own expense.

Disposal

 **DANGER**



Caution: contaminated parts
Contaminated parts can be detrimental to health and environment.
Before beginning to work, find out whether any parts are contaminated. Adhere to the relevant regulations and take the necessary precautions when handling contaminated parts.

 **WARNING**



Caution: substances detrimental to the environment
Products or parts thereof (mechanical and electric components, operating fluids etc.) can be detrimental to the environment.
Dispose of such substances in accordance with the relevant local regulations.

Separating the components

After disassembling the product, separate its components according to the following criteria:

- Contaminated components
Contaminated components (radioactive, toxic, caustic, or biological hazard etc.) must be decontaminated in accordance with the relevant national regulations, separated according to their materials, and recycled.
- Other components
Such components must be separated according to their materials and recycled.

Option

The anti rotation device is used for securing the shaft against rotary movements.

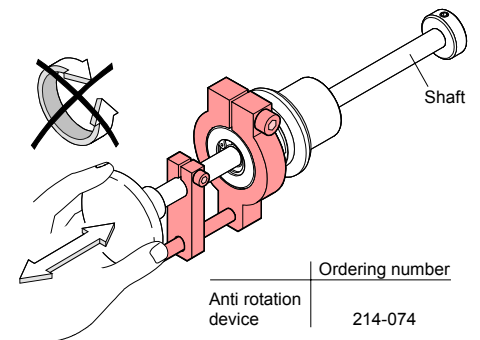

Declaration of Contamination

The service, repair, and/or disposal of vacuum equipment and components will only be carried out if a correctly completed declaration has been submitted. Non-completion will result in delay.
This declaration may only be completed (in block letters) and signed by authorized and qualified staff.

1 Description of product Type _____ Article Number _____ Serial Number _____	2 Reason for return _____ _____ _____																									
↓																										
3 Operating fluid(s) used _____ _____																										
↓																										
4 Process related contamination of product:																										
toxic no <input type="checkbox"/> corrosive no <input type="checkbox"/> biological hazard no <input type="checkbox"/> explosive no <input type="checkbox"/> radioactive no <input type="checkbox"/> other harmful substances no <input type="checkbox"/>	yes <input type="checkbox"/> yes <input type="checkbox"/> yes <input type="checkbox"/> *) yes <input type="checkbox"/> *) yes <input type="checkbox"/> *) yes <input type="checkbox"/>																									
*) Products thus contaminated will not be accepted without written evidence of decontamination!																										
↓																										
The product is free of any substances which are damaging to health yes <input type="checkbox"/>																										
↓																										
5 Harmful substances, gases and/or by-products Please list all substances, gases and by-products which may have come into contact with the product:																										
<table border="1" style="width: 100%; border-collapse: collapse;"> <thead> <tr> <th style="width: 20%;">Trade/product name manufacturer</th> <th style="width: 20%;">Chemical name (or symbol)</th> <th style="width: 15%;">Dangerous material class</th> <th style="width: 20%;">Measures in case of spillage</th> <th style="width: 25%;">First aid in case of contact</th> </tr> </thead> <tbody> <tr><td> </td><td> </td><td> </td><td> </td><td> </td></tr> <tr><td> </td><td> </td><td> </td><td> </td><td> </td></tr> <tr><td> </td><td> </td><td> </td><td> </td><td> </td></tr> <tr><td> </td><td> </td><td> </td><td> </td><td> </td></tr> </tbody> </table>		Trade/product name manufacturer	Chemical name (or symbol)	Dangerous material class	Measures in case of spillage	First aid in case of contact																				
Trade/product name manufacturer	Chemical name (or symbol)	Dangerous material class	Measures in case of spillage	First aid in case of contact																						
↓																										
6 Legally binding declaration: I/we hereby declare that the information on this form is complete and accurate and that I/we will assume any further costs that may arise. The contaminated product will be in accordance with the applicable regulations.																										
Organization/company _____ Address _____ Phone _____ Email _____ Name _____ _____ _____																										
Post code, place _____ Fax _____ _____ _____	Data and legally binding signature _____ Company stamp _____																									

This form can be downloaded from our website.

Copies:
Original for addressee - 1 copy for accompanying documents - 1 copy for file of sender

Manufacturer's Declaration

as defined by the Council Directive relating to machinery 98/37/EC, Appendix IIb

We, Inficon, hereby declare that putting the incomplete equipment mentioned below into operation is not permitted until evidence is given that the system into which that incomplete equipment shall be installed is in accordance with the provisions of the EC Council Directive relating to machinery.

Rotary/linear motion feedthrough

DN 40 ISO-KF
FCH040-H

Part number
214-324

Standards

Harmonized and international/national standards and specifications:

- 89/392/EEC version 93/68/EEC
- EN 292-1+EN 292-2 / 9.91

Signatures

Inficon AG, Liechtenstein
02 May 2000



Hans-Christoph Gehlhar
Product Management

02 May 2000



Hugo Frei
Product development



Postfach 1000
FL-9496 Balzers
Liechtenstein
Tel +423 / 388 45 67
Fax +423 / 388 54 58
reachfl@inficon.com
www.inficon.com